



## SHIRE OF BEVERLEY NOTICE OF MEETING

Notice is hereby given that the next Ordinary Meeting of Council will be held in the Council Chambers, 136 Vincent Street Beverley, on Tuesday 19 December 2023.

### **Program**

3.00pm – 5.00pm      Ordinary Meeting

A handwritten signature in black ink, appearing to read "S. Gollan", written over a horizontal line.

Stephen Gollan  
Chief Executive Officer

14 December 2023

### **DISCLAIMER**

*The recommendations contained in the Agenda are subject to confirmation by Council. The Shire of Beverley warns that anyone who has any application lodged with Council must obtain and should only rely on written confirmation of the outcomes of the application following the Council meeting, and any conditions attaching to the decision made by the Council in respect of the application. No responsibility whatsoever is implied or accepted by the Shire of Beverley for any act, omission or statement or intimation occurring during a Council meeting.*



**19 December 2023**

**ORDINARY MEETING**

**AGENDA**

## **CONTENTS**

<b>1. OPENING .....</b>	<b>4</b>
<b>2. ATTENDANCE, APOLOGIES AND LEAVE OF ABSENCE .....</b>	<b>4</b>
2.1 Members .....	4
2.2 Staff.....	4
2.3 Observers And Visitors .....	4
2.4 Apologies and Approved Leave of Absence .....	4
2.5 Applications for Leave of Absence .....	4
<b>3. DECLARATIONS OF INTEREST .....</b>	<b>4</b>
<b>4. RESPONSE TO PREVIOUS PUBLIC QUESTIONS TAKEN ON NOTICE .....</b>	<b>4</b>
<b>5. PUBLIC QUESTION TIME .....</b>	<b>4</b>
<b>6. CONDOLENCES .....</b>	<b>4</b>
<b>7. CONFIRMATION OF MINUTES .....</b>	<b>5</b>
7.1 Minutes of The Ordinary Council Meeting Held 28 November 2023 .....	5
7.2 Minutes of The Annual Electors Meeting Held 12 December 2023 .....	6
<b>8. TECHNICAL SERVICES .....</b>	<b>14</b>
<b>9. PLANNING SERVICES .....</b>	<b>15</b>
9.1 Proposed Road Closure – Unconstructed Road Reserve off Dobaderry Road, Westdale .....	15
9.2 Development Application: Single House – 117 (Lot 4) Vincent Street, Beverley .....	20
9.3 Town Square – Adoption of Revised Design Proposal .....	29
<b>10. BUILDING SERVICES &amp; ENVIRONMENTAL HEALTH SERVICES .....</b>	<b>36</b>
<b>11. FINANCE .....</b>	<b>37</b>
11.1 Monthly Financial Report .....	37
11.2 Accounts Paid by Authority .....	45
11.3 St John in the Wilderness Cemetery Record Digitisation (Unbudgeted Expense) .....	56
<b>12. ADMINISTRATION .....</b>	<b>85</b>
12.1 Disability Access and Inclusion Plan 2023 – 2028 .....	85
12.2 Policy Manual – Annual Review .....	109
<b>13. ELECTED MEMBERS’ MOTIONS WHERE NOTICE HAS BEEN GIVEN ...</b>	<b>313</b>
<b>14. NEW BUSINESS ARISING BY ORDER OF THE MEETING .....</b>	<b>313</b>
<b>15. CLOSURE .....</b>	<b>313</b>

## **1. OPENING**

The Presiding Member to declare the meeting open.

The Shire of Beverley acknowledge the Traditional Owners of the land on which we meet, the Ballardong People. We pay our respects to Elders past and present.

## **2. ATTENDANCE, APOLOGIES AND LEAVE OF ABSENCE**

### **2.1 Members**

Cr DC White	Shire President
Cr DJ Ridgway	Deputy President
Cr DL Brown	
Cr DW Davis	
Cr CJ Lawlor	
Cr JR Maxwell	
Cr AFC Sattler	

### **2.2 Staff**

Mr SP Gollan	Chief Executive Officer
Mr SK Marshall	Deputy Chief Executive Officer
Mr SP Vincent	Manager of Works
Mr BS de Beer	Manager of Planning and Development Services
Mrs A Lewis	Executive Assistant

### **2.3 Observers And Visitors**

### **2.4 Apologies and Approved Leave of Absence**

Cr SW Martin	Approved Leave of Absence
--------------	---------------------------

### **2.5 Applications for Leave of Absence**

## **3. DECLARATIONS OF INTEREST**

## **4. RESPONSE TO PREVIOUS PUBLIC QUESTIONS TAKEN ON NOTICE**

Nil

## **5. PUBLIC QUESTION TIME**

## **6. CONDOLENCES**

Nil



## **7. CONFIRMATION OF MINUTES**

### **7.1 Minutes of The Ordinary Council Meeting Held 28 November 2023**

#### **OFFICER'S RECOMMENDATION**

That the Minutes of the Ordinary Council Meeting held Tuesday 28 November 2023 be confirmed.

## **7.2 Minutes of The Annual Electors Meeting Held 12 December 2023**

### **OFFICER'S RECOMMENDATION**

That the Minutes of the Annual General Meeting of Electors held Tuesday 12 December 2023 be received.



**ANNUAL ELECTORS MEETING MINUTES  
For The Financial Year Ended 30 June 2023  
Held At The Cornerstone Function Room,  
141 Vincent Street, Beverley  
On Tuesday 12 December 2023  
Commencing At 10am**

**1. Commencement of Meeting**

The President, Cr White declared the meeting opened at 10:00am.

**2. Attendance and Apologies**

**Attendance**  
**Councillors**

Cr D White	Shire President
Cr D Ridgway	Deputy President
Cr D Brown	
Cr D Davis	
Cr S Martin	
Cr J Maxwell	

**Staff**

Mr S Gollan	Chief Executive Officer
Mr S Marshall	Deputy Chief Executive Officer
Mr S de Beer	Manager of Planning
Mr S Vincent	Manager of Works
Ms A Lewis	Executive Assistant

**Public**

Mrs G Petchell	Mr P Jenkin	Mrs J Rayner
Mr L Shaw	Mr R Parrick	Mr M Vivian
Mrs B Vivian	Mrs S Collins	Ms J Foster
Ms S Ives		

**Apologies**

Cr A Sattler	Mrs A Fleay	Mr F Bremner
--------------	-------------	--------------

Annual Electors Meeting for Financial Year Ended 30 June 2023  
12 December 2023

**3. Confirmation of Previous Minutes**

**MAE1/1223**

**Moved: Cr S Martin**

**Seconded: Mrs G Petchell**

**That the Minutes of the Annual Electors Meeting for the Financial Year Ended 30<sup>th</sup> June 2022, held in the Cornerstone Function Room, 141 Vincent Street, Beverley, on Wednesday 7 December 2022, be confirmed.**

**CARRIED UNANIMOUSLY**

**4. Business Arising from Previous Minutes**

Nil

**5. Adoption of 2022-2023 Annual Report**

**MAE2/1223**

**Moved: Cr D Ridgway**

**Seconded: Cr S Martin**

**That the Annual Report for the Financial Year ended 30 June 2023, be received.**

**CARRIED UNANIMOUSLY**

**6. Shire President's Report**

The Shire President read the following report:

Good morning Ladies and Gentlemen and welcome to the Electors' meeting for 2023. As we take time to reflect on the year passed and look forward to projects planned for next year and beyond.

**Recent Elections**

With recent elections, I would like to take the opportunity to congratulate Mr. Chris Lawlor on his re-election and Mrs. Dee Ridgway and Mr. Darryl Brown on their elections. Although one might well say of the latter two, on their 're-elections'.

It is important to also note and thank the outgoing Councillors Mr. Peter Gogol, Mr. Tim Seed, and Mr. Matt Norman for their service to the Shire and community during their tenure. Peter Gogol served for 16 years, Tim Seed for 6 years and Matt Norman just under two years.

On behalf of the community; Thank You.

**Vincent Street**

The Defects Liability Period for Vincent Street ended on 10<sup>th</sup> October this year and Management have been working with GHD and MG Group to identify issues that require attention. Among these is the failure of some bituminised areas along the street where water has caused the surface to move and crack.

Annual Electors Meeting for Financial Year Ended 30 June 2023  
12 December 2023

Arrangements are now in place to rectify these areas in January 2024 when the street will be at its quietest. Those areas requiring repair will be closed off to traffic while repairs are effected. This will necessitate the removal of the bitumen and cement stabilisation before the replacement of the hotmix. This will be an inconvenience for the period of the repairs and we ask your patience while this is being carried out.

During the week of the Planning Institute of Australia Awards held recently, Beverley nominated the Vincent Street project for two categories being "Great Place" and "Best Regional Project". In both categories Beverley was awarded High Commendation for the project and it was additionally pleasing when some attendees offered their personal congratulations to Beverley.

### **Roads and Bridges**

In last year's report I informed the meeting that a greater focus on roads and bridges would be a priority for 2023. The bridges in the Shire were suitable once for small loads but now must meet the needs of Road Trains and heavier farm machinery. Completed in the first half of the previous century, most bridges have also deteriorated with time and while annual maintenance has always been carried out, it cannot stop the natural deterioration.

During the year, funding has been secured through Main Roads to begin the upgrading and renewal process. The Bridge on Bremner Road is due to renewal in 2024 and funding has been acquired for the bridge on the York Williams road number 3197, the one near George Smith's property.

All this was not helped when we had the short but severe thunderstorm in March of this year. The damage to roads and culverts was considerable. At an estimated cost of around \$3 million, it was beyond the Shire's financial ability to deal. An application to DFES to have our area declared a disaster area to enable an application for emergency funding was lodged in April was approved at the end of May. Ongoing dealings with DFES in this matter would be greatly assisted if Main Roads were involved in the assessment process.

An engineering Firm, HC Constructions, has finalised a full report on the damage and we can now apply for the necessary funding to make the repairs. From this work HC Constructions have identified about 500 sites throughout the Shire.

An invitation was also made to the Minister for Roads Rita Saffiotti to visit Beverley to familiarise herself with the considerable damage facing us. Further invitations have subsequently been made without any result.

This year a decision was also made to employ contractors to undertake work on certain road construction to allow the outside crew to concentrate on maintenance and sheeting. The firm of Earthstyle Contracting has been engaged and they have

Annual Electors Meeting for Financial Year Ended 30 June 2023  
12 December 2023

completed their first contract on the Mawson Road. Work on the Waterhatch Road and Morbinning Road will follow in the new year.

### **Swimming Pool**

A complete design and plan for the redevelopment of the swimming pool area was completed some years ago and the project stands shovel ready. As I pointed out last year, the cost of the project has increased by about 90% reaching a point that it is now beyond our means to complete in one stage.

It was therefore decided to break it into stages with Stage 1 being the renewal of the Plant room, plumbing, installation of a wet deck, new diving blocks, a ramp and staircase for disabled, and some landscaping. Tenders will be called for this first stage to provide an idea of the cost. An application for Grant funding and the raising of a new loan of up to \$1million is planned to enable this Stage to be carried out. Naturally, the price of Tenders will determine whether we will be able to go through with it.

### **Nurses' Quarters**

Discussions with Landgate over the acquisition of the Nurses' Quarters has been ongoing for some time. An initial proposal from Landgate was that the Shire purchase the site for \$100,000. Such a purchase price was never envisioned in preliminary discussions so it came as quite a surprise.

Further proposals were considered until the Shire and Landgate were able to come to an agreement that the Shire would apply for a Management Order over the land and building. We are still awaiting the finalisation of this application and until it is received, we can do nothing to progress this project. At this stage the Shire has not settled on any definite plan for the building although many suggestions have come from the community.

### **Accommodation for Health Workers**

Last year the Shire was visited by two people from the Health Department to discuss the possibility of the Shire building accommodation for Nurses and other Health workers in Beverley which would be leased by the Health Department. This accommodation would be available for regional use with surrounding towns being able to utilise it. While the Shire was encouraged to consider this proposal, no further contact has been received from the Health Department.

### **Old School Building**

Plans to convert this building into a formal Civic Centre also accommodating Council Chambers, are now well in hand and the work should be commenced this year. This will help relieve some pressure in the current Shire offices where space is at a

Annual Electors Meeting for Financial Year Ended 30 June 2023  
12 December 2023

premium. Moving the library into the Cornerstone Building was a first step to ensure that we don't have to face the construction of a new Administration Building.

HC Constructions is the firm who have been engaged to manage this project.

For the monthly markets, it is envisaged at this point, that they might be accommodated in the Town Hall. A final decision will be made after further consultation with the organisers.

### **Beverley 2035**

Finally, we come to a potential project that has very recently been identified but has yet to go to full Council for discussion and approval. A federal government funding scheme known as Regional Precincts and Partnership Program is open for application for projects that are based on partnerships covering a relevant area identified as a Precinct.

Divided into two Stages, with Stage one being funding just for planning and Stage two, being applications for funding for the actual work.

At this stage I am unable say more as we are very much in the initial stage of considering what this all means and how we might participate to enable Beverley to achieve the projects of which we are currently aware.

Among these projects we can include the swimming pool, the Hunt Road Village expansion, extension of the deep sewerage, a new Child Day-Care Centre, assistance to expand HACC services for the elderly, the Nurses' Quarters, Avondale, extension to the Recreation Centre and others yet to be fixed.

It is very early days and determination from Council is required before an approach can be adopted to enable Council to proceed. Mark Casserly has been tentatively engaged to assist the Council with this project and all of this will be discussed at next week's Council meeting.

Unfortunately, this programme has a very tight timetable and there is a lot to be considered. It opened in August 2023 and closes in late 2026. It is also limited in its funding. The total fund is only \$400 million for the whole of Australia. \$80 million for Stage one and \$320 million for Stage two.

### **Outlook**

As we step into 2024, we do so with optimism necessary to plan to achieve for Beverley, all the projects that we would like to improve the facilities and amenity of Beverley to make it a prime place to live and visit.

### **Conclusion**

In conclusion, I would like to acknowledge and thank:

Annual Electors Meeting for Financial Year Ended 30 June 2023  
12 December 2023

1. The Councillors who have put in a significant effort and given me great support;
2. All the do not staff, both inside and out, for their efforts;
3. To the senior staff and Stephen Gollan who provides exemplary leadership and who is always willing to meet with community members; and.
4. To all the community organisations of every nature and the volunteers, for your efforts to make a difference to life in Beverley.

Finally. On behalf of Council, may I wish everyone a very Merry Christmas and may 2024 be all you hope for and that brings peace and prosperity.

## 7. Annual Report Questions

Nil

(Ms Sherelle Ives asked a question unrelated to the Annual Report)

## 8. General Business

### Written questions received:

8.1 – Mrs B Vivan

Is it possible to have the road marking, depicting the lawful place to stop, before proceeding through the intersection at Vincent Street and Forrest Street, moved a little forward?

**Yes, Staff will contact Main Roads to have them review the intersection and repainted if approved.**

8.2 – Mr L Shaw

My question is there any thought of modifying the parking spaces in the main street so that the entry and exit points are not at right angles but can be sloped to 45 degrees. This would enable cars to park without running over the steep curb.

**At this point, Council is not proposing to alter the current curbing. A number of garden beds will have the roadside edges filled to make it easier should vehicles inadvertently drive over them.**

Also the removal of the large stones which at the moment do not serve any real purpose would save a lot of unnecessary damage to cars.

**A number of the stones have been and will be relocated or moved to avoid any damage to cars whilst parking.**

In response, Mr L Shaw asked, can Council consider in the future if funding becomes available?

**Noted**



Annual Electors Meeting for Financial Year Ended 30 June 2023  
12 December 2023

8.3 – Mrs J Rayner

When will the Airport Lighting be installed?

**A tender has been awarded. Installation will commence in February 2024. The lights will be hardwired.**

When will the DEFIB signage be placed around town?

**The CEO commented at the meeting that this had not been done yet. However, on review, three signs have been displayed. The rest of the signs will be placed at the requested locations in January 2024.**

The nuts on the footpath around the hospital are still a concern, can something please be done?

**The CEO will ask gardening staff to attend to this regularly.**

**Questions from the Floor – Not recorded verbatim, summary only.**

8.4 – Mr L Shaw

Is there a cost for the Old School Building construction?

**The cost is approximately \$624,000.00**

8.5 – Mrs J Foster

Is there a date for the commencement of construction the Old School Building?

**There is a meeting with the contractors next Wednesday (20 December 2023). Once Council knows more, they will be in contact about the Markets.**

8.6 – Ms S Ives

Thanked Council for providing good accommodation at the caravan park.

**Noted**

## **9. Meeting Closure**

As there were no further questions, the Shire President declared the meeting closed at 10:24am.

I hereby certify these Minutes as being confirmed in accordance with Section 5.22 of the Local Government Act 1995.

**Presiding Member:**

**Date:**

## **8. TECHNICAL SERVICES**

Nil

## **9. PLANNING SERVICES**

### **9.1 Proposed Road Closure – Unconstructed Road Reserve off Dobaderry Road, Westdale**

---

<b>Submission To:</b>	<b>Ordinary Council Meeting 19 December 2023</b>
<b>Report Date:</b>	<b>4 December 2023</b>
<b>Applicant:</b>	<b>P. Gibbs</b>
<b>File Reference:</b>	<b>RO 005</b>
<b>Author and Position:</b>	<b>Stefan de Beer, Manager of Planning</b>
<b>Previously Before Council:</b>	<b>-</b>
<b>Disclosure(s) Of Interest:</b>	<b>None</b>
<b>Attachments:</b>	<b>Application Email, Locality Map</b>

---

#### **SUMMARY**

A request has been received from an affected landowner (Philip Gibbs) that a portion of unconstructed Road Reserve be closed. It will be recommended that Council resolve to initiate closure of the subject section of the unconstructed road reserve.

#### **BACKGROUND**

Council received a written request for Road Closure from the affected landowner. The application email and mapping are attached to this report.

The applicant submits that the closure is requested to address land management considerations on his property, being 57 (Lot 110) Dobaderry Road, Westdale.

#### **COMMENT**

It is submitted that the closure of the section of unconstructed road reserve will address the matters as raised by the applicant.

#### **CONSULTATION & ADVERTISING**

Should Council initiate the Road Closure, public advertising must be conducted for a minimum of 35 days.

#### **STATUTORY ENVIRONMENT**

Roads are closed pursuant to Section 58 of the *Land Administration Act 1997* in compliance with *Land Administrative Regulations 1998*.

#### **FINANCIAL IMPLICATIONS**

The road closure process will require advertising.

#### **STRATEGIC IMPLICATIONS**

Strategic Pillar: 4. Civic Leadership  
Strategic Priorities: 4.3 Responsible planning

#### **POLICY IMPLICATIONS**

There are no policy implications relative to this application.

#### **RISK IMPLICATIONS**

It is considered that the proposal has insignificant risks.

Consequence	Insignificant	Minor	Moderate	Major	Catastrophic
<b>Likelihood</b>					
Almost Certain	Medium (5)	High (10)	High (15)	Severe (20)	Severe (25)
Likely	Low (4)	Medium (8)	High (12)	High (16)	Severe (20)
Possible	Low (3)	Medium (6)	Medium (9)	High (12)	High (15)
Unlikely	Low (2)	Low (4)	Medium (6)	Medium (8)	High (10)
Rare	Low (1)	Low (2)	Low (3)	Low (4)	Medium (5)

Risk Rating	Action
Low	Monitor for ongoing improvement.
Medium	Comply with risk reduction measures to keep risk as low as reasonably practical.
High	Review the risk and take additional measures to ensure risk is low as reasonably achievable.
Severe	Unacceptable risk level, reduction measures must be introduced before proceeding.

## VOTING REQUIREMENTS

Simple Majority

## OFFICER'S RECOMMENDATION

That Council initiate the closure of a section of unconstructed Road Reserve off Dobaderry Road as depicted in the attached drawing and instruct the Shire Planner to commence with the required advertising for road closure.

### Proposed Road Closure

Section of unconstructed road reserve to be closed



Affected property:  
57 Dobaderry Road,  
Westdale

Shire of  
Beverley





**From:** [Philip Gibbs](#)  
**To:** [Stefan De Beer](#)  
**Subject:** Land acquisition  
**Date:** Tuesday, 21 November 2023 12:10:21 PM  
**Attachments:** [IMG\\_2023-11-21-11-53-10-047.jpg](#)

---

**CAUTION:** This email originated from outside of the organisation. Do not click links or open attachments unless you recognise the sender and know the content is safe.

Good day Stefan,

We previously spoke about the possibility of me acquiring, on behalf of the Gibbs Family Trust, the land shown in red on the attached photo, being a road reserved owned by the Shire.

In the event that both ends of this reserve have been transferred to other titles, I would be quite sure that this reserve will never be required for a road.

I should like to add this small piece of land of land to my title as the present North boundary of P300169 has a large rock outcrop which restricts access down that boundary and prevents the construction of an effective fire break.

I should like to apply to acquire this from the Shire subject to agreeable terms being offered.

Philip Gibbs for  
Behmarlei Pty Ltd ATF  
Gibbs Family Trust  
57 Dobaderry Road  
Westdale 6304



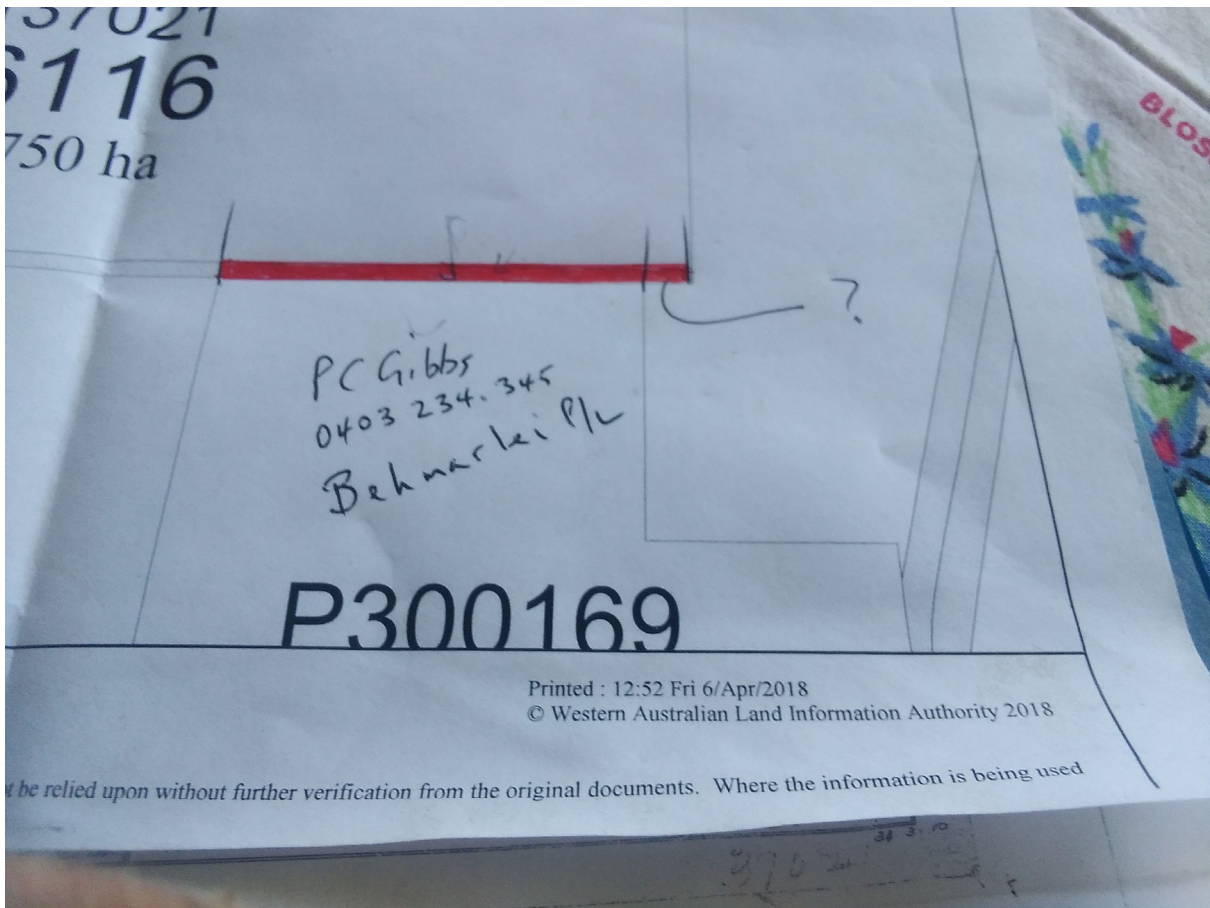

## **9.2 Development Application: Single House – 117 (Lot 4) Vincent Street, Beverley**

---

<b>Submission To:</b>	<b>Ordinary Council Meeting 19 December 2023</b>
<b>Report Date:</b>	<b>4 December 2023</b>
<b>Applicant:</b>	<b>T. Finnigan</b>
<b>File Reference:</b>	<b>VIN 459</b>
<b>Author and Position:</b>	<b>Stefan de Beer</b>
<b>Previously Before Council:</b>	<b>-</b>
<b>Disclosure(s) Of Interest:</b>	<b>None</b>
<b>Attachments:</b>	<b>Locality Map, Application Letter, Site Plan, Photo</b>

---

### **SUMMARY**

An application was received to use the subject property – 117 (Lot 4) Vincent Street as a single house. The application will be recommended for approval.

### **BACKGROUND**

The subject lot is located at 117 (Lot 4) Vincent Street (the former Elders Shop), is 1,159 m<sup>2</sup> in extent and zoned *Rural Townsite* in terms of the *Shire of Beverley Local Planning Scheme No. 3 (LPS3)*. It contains existing buildings (offices and sheds).

The applicant proposes to change the use of a portion of an existing building to be used as a Single House. Please refer to the attached application documentation for details of the proposal.

A *Single House* land use is a 'D' use in the *Rural Townsite Zone* pursuant to Zoning Table 3 of LPS 3, which means that the use is not permitted unless the local government has exercised its discretion by granting development approval.

### **COMMENT**

The applicant submits that the original use of the subject lot was for single house/residential purposes – specific dates unknown. In order for the applicant to use the subject lot as a residential property, Councils approval through a planning application is required.

Council has in the past approved similar requests for a *Single House* land use within the *Rural Townsite Zone*, ie. 46 Dawson Street, 38 Queen Street & 40 Queen Street.

It is important to note that the granting of planning approval for a Residential Land Use within the *Rural Townsite Zone*, does not change the Zoning of the subject land. Future commercial land uses would still be potentially permissible.

### **PUBLIC NOTIFICATION**

No public notification was deemed required for this application.

### **STATUTORY ENVIRONMENT**

Shire of Beverley Local Planning Scheme No. 3.

### **FINANCIAL IMPLICATIONS**

There are no financial implications relative to this application.



## STRATEGIC IMPLICATIONS

Strategic Pillar: 4. Civic Leadership  
Strategic Priorities: 4.3 Responsible planning

## POLICY IMPLICATIONS

There are no policy implications relative to this application.

## RISK IMPLICATIONS

It is considered that the proposal has insignificant risks.

Consequence	Insignificant	Minor	Moderate	Major	Catastrophic
<b>Likelihood</b>					
Almost Certain	Medium (5)	High (10)	High (15)	Severe (20)	Severe (25)
Likely	Low (4)	Medium (8)	High (12)	High (16)	Severe (20)
Possible	Low (3)	Medium (6)	Medium (9)	High (12)	High (15)
Unlikely	Low (2)	Low (4)	Medium (6)	Medium (8)	High (10)
Rare	Low (1)	Low (2)	Low (3)	Low (4)	Medium (5)
<b>Risk Rating</b>	<b>Action</b>				
Low	Monitor for ongoing improvement.				
Medium	Comply with risk reduction measures to keep risk as low as reasonably practical.				
High	Review the risk and take additional measures to ensure risk is low as reasonably achievable.				
Severe	Unacceptable risk level, reduction measures must be introduced before proceeding.				

## VOTING REQUIREMENTS

Simple Majority

## OFFICER'S RECOMMENDATION

That Council resolve to grant planning approval for a Single House at 117 (Lot 4) Vincent Street, Beverley, subject to the following conditions and advice notes:

### Conditions:

1. Development shall be carried out only in accordance with the terms of the application as approved herein and any approved plan, prepared by the applicant and endorsed by Council's Shire Planner.

### Advice Notes:

- Note 1: If the development the subject of this approval is not substantially commenced within a period of 2 years, or another period specified in the approval after the date of determination, the approval will lapse and be of no further effect.
- Note 2: Where an approval has so lapsed, no development shall be carried out without the further approval of the local government having first been sought and obtained.
- Note 3: Nothing in the approval or these conditions shall excuse compliance with all relevant written laws in the commencement and carrying out of the development.
- Note 4: The applicant is advised a building permit is required prior to commencement of any building works.

Note 5: If an applicant is aggrieved by this decision there is a right of review by the State Administrative Tribunal in accordance with the *Planning and Development Act 2005* Part 14. An application must be made within 28 days of the determination.



117 (Lot 4) Vincent Street



Created: 1 December 2023 from Map Viewer Plus: <https://maps.landgate.wa.gov.au/maps-landgate/registered/>



T. FINNIGAN  
 P.O. Box 46.  
 BEVERLEY 6304  
 W.A.

SHIRE OF BEVERLEY		
29 NOV 2023		
FILE REF: VIN459		
<input type="checkbox"/> CEO	<input type="checkbox"/> SP	<input type="checkbox"/> TO
<input type="checkbox"/> DCEO	<input type="checkbox"/> EHOB	<input type="checkbox"/> PO
<input type="checkbox"/> MOW	<input type="checkbox"/> CESM	<input type="checkbox"/> .....

At. 0405256312

TO WHOM IT MAY CONCERN,  
 I'm NOT APPLYING TO BUILD ANYTHING, I  
 WOULD LIKE TO LIVE IN THE ORIGINAL  
 BUILDING, WHICH ALREADY HAS WATER ETC  
 CONNECTED.

FROM WHAT I HAVE BEEN ABLE TO FIND OUT,  
 THE BUILDING WAS USED AS A HOUSE (PHOTO  
 ATTACHED), BEFORE ELDERS EXTENDED IT  
 AND BUILT SHEDS AT THE REAR.

ALL I WOULD LIKE TO DO, IS BE ABLE TO LIVE  
 IN IT AND USE THE SHEDS FOR MY OWN  
 PERSONAL USE NOT A BUSINESS!

WHICH IS WHY I'M APPLYING FOR MY  
 PROPERTY TO BE RESIDENTIAL, NOT COMMERCIAL  
 THE BUILDINGS WILL NOT BE ALTERED ON THE  
 OUTSIDE AT ALL (APART FROM BEING TIDYED  
 UP) THANK YOU.

J. J. Finigan . 29-11-23



**SHIRE OF BEVERLEY**

**29 NOV 2023**

FILE REF: VIN 459

<input type="checkbox"/> CEO	<input type="checkbox"/> SP	<input type="checkbox"/> TO
<input type="checkbox"/> DCEO	<input type="checkbox"/> EHOB	<input type="checkbox"/> PO
<input type="checkbox"/> MOW	<input type="checkbox"/> CESM	<input type="checkbox"/> .....

ACCOUNT NUMBER:  
**90 07817 13 7**

PROPERTY ADDRESS:  
**117 VINCENT ST  
BEVERLEY Lot 4**



**TM FINNIGAN  
PO BOX 46  
BEVERLEY WA 6304**

053/240/

17 November 2023



## Chanmge in classification

Good morning Terence,

Thank you for your recent contact in relation to the change is classification at your property above,

I have contacted the Shire of Beverley to confirm with them that they have approved the change in classification from non residential office to residential house. They have advised that they have not received any plans to change the classification. You will need to do this and have council approval for us to change our records also.

In regards to the removal of major fixtures, we would need to see a plumbers report showing that the major fixture has been cut and sealed correctly so that we can reduce the amount of major fixtures on your account. If you have this report; please send it through to [Rating.Services@watercorporation.com.au](mailto:Rating.Services@watercorporation.com.au) and we will be able update our records. ~~WA~~

For any further questions, please get in touch on **13 13 85** or chat with us on our website. We'll be happy to help.

Kind regards,  
**Rating Services**  
Water Corporation

*PA 3M*

*RATING SERVICES AT  
WATER COMP. CO. AU.*



PRINT\_MAIL\_WTR\_557540\_476\_1\_dix\_001/E-240/S-365/729/

P. ROAD  
6289 m<sup>2</sup>

Western Australia Land Information Authority

Attachment for Item 9.2

117 (LOT 4) VINCENT STREET

P. ROAD  
1829 m<sup>2</sup>

OPEN  
DISPLAY AREA  
- -  
HOUSE  
AREA.

P95 3  
1214 m<sup>2</sup>

P. ROAD  
6289 m<sup>2</sup>

117

STORAGE  
SITED.

P95 4  
1159 m<sup>2</sup>

CAR WORK AND  
PARKING SITED.

P2277 73  
1014 m<sup>2</sup>

P2277 70  
1.5224 ha

P. ROAD  
9048 m<sup>2</sup>

Land Information Authority



Created: 24 November 2023 from Map Viewer Plus: <https://maps.landgate.wa.gov.au/maps-landgate/registered/>

Copyright, Western Australia Land Information Authority. No part of this document or any content appearing on it may be reproduced or published without the prior written permission of Landgate. Disclaimer: The accuracy and completeness of the information on this document is not guaranteed and is supplied by Landgate 'as is' with no representation or warranty as to its reliability, accuracy, completeness, or fitness for purpose. Please refer to original documentation for all legal purposes.



## Business Expansion

### STOCK FIRM'S ENTERPRISE

Indicative of expanding business is the decision of Messrs Eldei Smith and Co., Limited, to make substantial additions to their Beverley premises, work on which is proceeding apace.

The job in hand at the moment includes the extension of the present building to the street alignment and these additions will constitute show rooms, etc.

Other all-round improvements will be effected in due course.

Manager J L McGowan returned this week after holidaying at Bunbury for the past three weeks.

### Mr. J. I. Mann's Holiday

Mr and Mrs J I Mann left this week for a holiday in New Zealand. Before his departure Mr Mann arranged with Mr G Cornell, MLA, of Kellerberrin, to watch the interests of Mr Mann's Avon Valley electorate. Local interests may contact Mr Cornell, C/o Parliament House. Mr and Mrs Mann will be returning about the middle of April.

## Cricketers Barbecue

### SUCCESSFUL FUNCTION

## RSL Cricket

### COMING FIXTURES

The Beverley RSL Cricket Club will have quite a busy time in the next few days. On Sunday they will journey to York where they will engage Quellington in an all-day game at that centre. This match is timed to start at 10.30 a.m. and supporters who desire to make the trip are advised that a bus will leave the Beverley post office at 9.15 a.m. sharp.

On Monday next (Labour Day) the local representatives will be engaged in an all-day game on the recreation ground. Their opponents on this occasion will be a representative South Perth social eleven. Included among the visiting players will be Cyril Edwards, who some years ago proved to be one of the stalwarts of the game in this district. The team to represent Beverley RSL for both matches will be selected from the following: E Monger, A Husking, K, B and A Willey, R Falkingham, A Sing, A Ware, B Noonan, F and R McCloy, R Bartram, A Honess, J Treasure, W Feazey, N Gray, A Bottcher.

### City of Perth Return Match

Arrangements are now in hand for the Beverley RSL Club to play a return game against the City of Perth Club on Sunday, March 11. When the city of

## Bus Trip to Z

Messrs Swan and S will run to the South Pe on Sunday, MARCH 10 residents wishing to n trip should contact their A Moxon without delay

## Mostly Perso

Mrs A L O'Brien, of l is an inmate of a city he Mr and Mrs W B have left for holidays South-West.

Mr and Mrs Allan Co to holiday in Albany for weeks.

Among those to ret week are Mr and Mrs P have been holidaying relatives in the East for three weeks.

Records are being on the number of pre-wedd ctions held in the distric One of the most conv the barbecue arranged Trevor Barrett-Lennard and held at the Dale on 21st. Trevor is to be n Miss Audrey Wilhelm, erley, to-morrow w friends gathered to wis the best and to make a tation as a mark of este Miss Sheila Hodgs

Fri 2 Mar 1951 - The Beverley Times (WA: 1905 - 1977)

Page 7 - Business Expansion

Business Expansion

STOCK FIRM'S ENTERPRISE

Indicative of expanding business

is the decision of Messrs

Eldei Smith and Co., Limited, to

make substantial additions to

their Beverley premises, wotfk on

which is proceeding apace.

The job in hand at the moment

includes the extension of the

present building to the street

alignment and these additions

will constitute show rooms, etc.

Other all-round improvements

will be effected in due course.

Manager J L McGowan returned

this week after holidaying

117 VIRGENT ST  
(1951)?  
P.T.O.



### **9.3 Town Square – Adoption of Revised Design Proposal**

---

<b>Submission To:</b>	<b>Ordinary Council Meeting 19 December 2023</b>
<b>Report Date:</b>	<b>13 December 2023</b>
<b>Applicant:</b>	<b>Shire of Beverley</b>
<b>File Reference:</b>	<b>ADM 0531</b>
<b>Author and Position:</b>	<b>Stefan de Beer, Manager of Planning</b>
<b>Previously Before Council:</b>	<b>22 September 2020</b>
<b>Disclosure(s) Of Interest:</b>	<b>None</b>
<b>Attachments:</b>	<b>Originally Adopted Town Square Design Proposal, Revised Town Square Design Proposal, Detailed Design Elements, Letter from Beverley Post Office</b>

---

#### **SUMMARY**

Council is requested to formally adopt a revised Design Proposal for the Town Square area in anticipation of commencement of implementation of the project.

#### **BACKGROUND**

Council at its meeting of 22 September 2020 resolved as follows:

*That Council resolve to adopt the Vincent Street – Streetscape Project Design as presented in the attached documents, and acknowledge that minor variations that will not materially deviate from the project description and outcome, might occur as required, during implementation of the project.*

The above Urban Design Proposals included the entire Vincent Street precinct inclusive of the Town Square area.

The new Town Square design presented herewith deviates from the design previously adopted by Council.

#### **COMMENT**

To enable the project to progress to implementation stage it is prudent that formal Council consensus be on record, through formal resolution, as to the design specifics of the project.

It is submitted that the revised design proposal submitted herewith is more practical and affordable to implement than the originally adopted design prepared by GHD.

The revised design includes practical elements as shown on the attached plan, i.e. formed concrete seating and the retention of elements that has community sentiment i.e. the wishing well and water fountain.

#### **PUBLIC CONSULTATION**

The new Town Square Design Proposal was published in the *Beverley Blarney* of December 2023 with an invitation to comment.

A submission was received from Beverley Post Office – letter attached. They are requesting that the project be put on hold until sufficient funds can be sourced to implement the original design proposal.

As a result of anticipated budgetary constraints, the Town Square portion of the *Vincent Street – Streetscape Project* was presented as a separable portion in the 2021 Tender Package when tenders were called for the Streetscape Project. Tenders received (for the original Town Square design portion only) are reflected below:

Company A:	\$262,917
Company B:	\$319,333
Company C:	\$420,704

It is not regarded as financially feasible to further entertain the original design proposal as no doubt the above construction costs would have escalated since first being tendered on.

### STATUTORY ENVIRONMENT

Shire of Beverley Local Planning Scheme No. 3.

### FINANCIAL IMPLICATIONS

Shire of Beverley has budgeted \$75,000 for the project as presented in this report.

### STRATEGIC IMPLICATIONS

Strategic Pillar: 1. Economy  
4. Civic Leadership  
Strategic Priorities: 1.3 Beverley attractions and experiences are promoted  
4.3 Responsible planning

### POLICY IMPLICATIONS

There are no Policy Implications relative to this issue.

### RISK IMPLICATIONS

It is considered that the proposal has insignificant risks.

Consequence	Insignificant	Minor	Moderate	Major	Catastrophic
<b>Likelihood</b>					
Almost Certain	Medium (5)	High (10)	High (15)	Severe (20)	Severe (25)
Likely	Low (4)	Medium (8)	High (12)	High (16)	Severe (20)
Possible	Low (3)	Medium (6)	Medium (9)	High (12)	High (15)
Unlikely	Low (2)	Low (4)	Medium (6)	Medium (8)	High (10)
Rare	Low (1)	Low (2)	Low (3)	Low (4)	Medium (5)
<b>Risk Rating</b>	<b>Action</b>				
Low	Monitor for ongoing improvement.				
Medium	Comply with risk reduction measures to keep risk as low as reasonably practical.				
High	Review the risk and take additional measures to ensure risk is low as reasonably achievable.				
Severe	Unacceptable risk level, reduction measures must be introduced before proceeding.				

### VOTING REQUIREMENTS

Simple Majority

### OFFICER'S RECOMMENDATION

That Council resolve to adopt the revised Town Square Design Proposal as presented in the attached document and acknowledge that minor variations might occur as required during implementation of the project.



DESIGN TO BE PRICED SEPARATELY

ORIGINALLY ADOPTED DESIGN

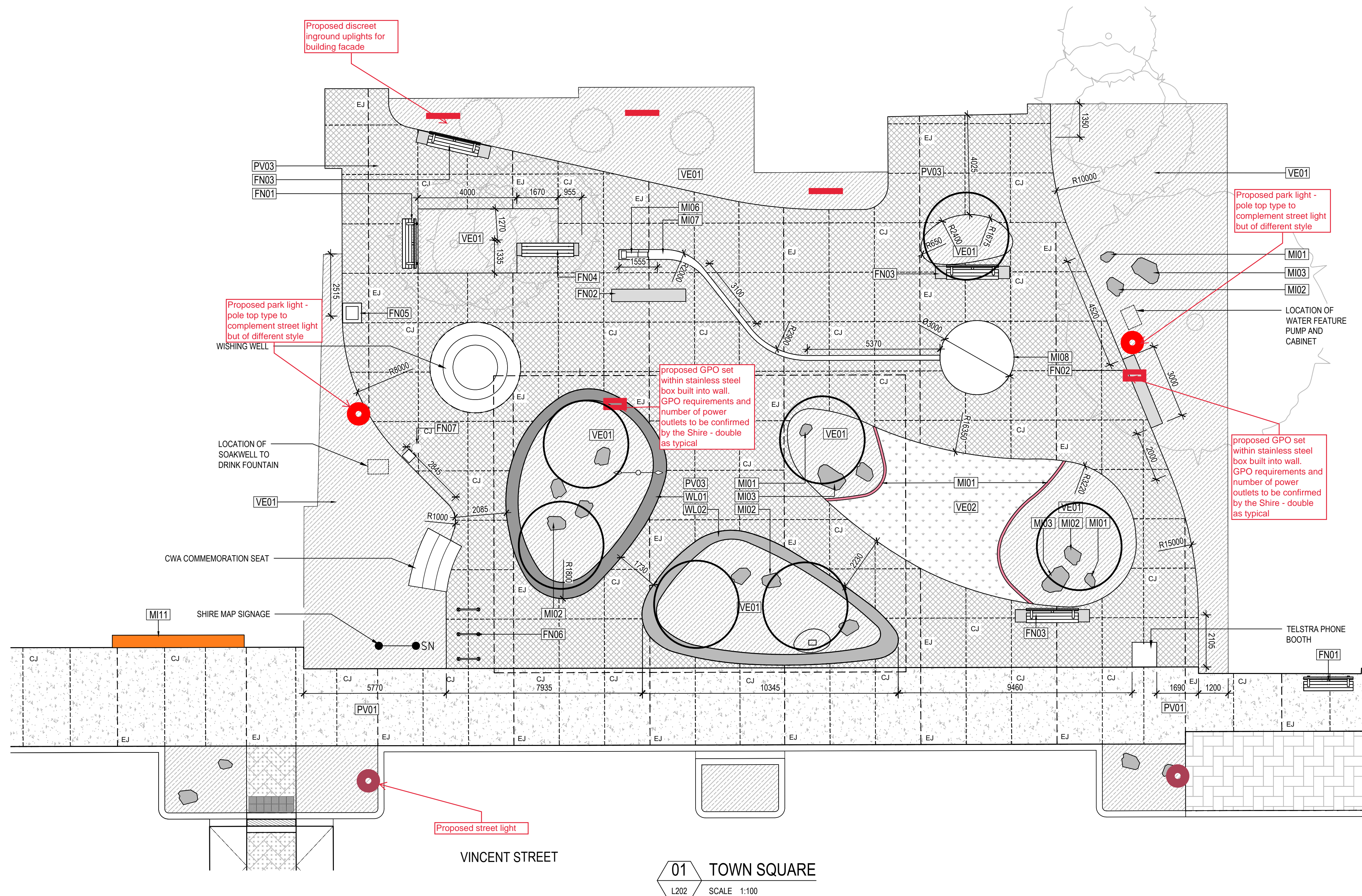
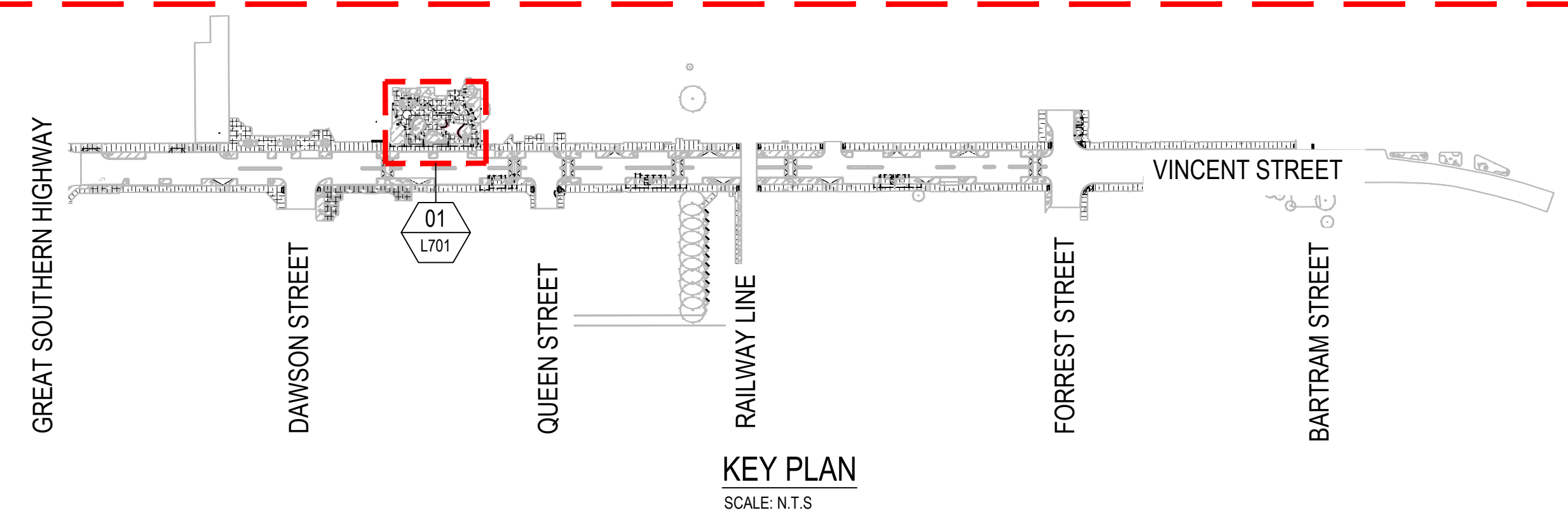

TENDER ISSUE

No	Revision	Note: * indicates signatures on original issue of drawing or last revision of drawing	Drawn	Job Manager	Project Director	Date
0	ISSUE FOR TENDER		VC/RT	IP	RK	27/10/20
A	85% CLIENT REVIEW		VC/RT	IP	RK	12/10/20

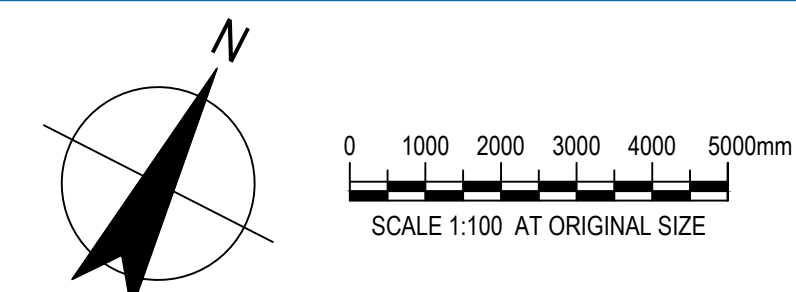

Level 10, 999 Hay Street Perth WA 6000  
PO Box Y3106 Perth WA 6832 Australia  
T 61 8 6222 8222 F 61 8 6222 8555  
E permail@ghd.com.au W www.ghd.com

DO NOT SCALE		Drawn	Designer
Conditions of Use. This document may only be used by GHD's client (and any other person who GHD has agreed can use this document) for the purpose for which it was prepared and must not be used by any other person or for any other purpose.		V.CHAN / R.TIEN	I.PEXTON
		L.ORREAL	M.DALTON
		R.KIPERMAN (Project Director)	
		Date	
		27/10/20	
		Scale	AS SHOWN

Client	Project	Title	Original Size	Drawing No:	Rev:
SHIRE OF BEVERLEY	VINCENT STREET STREETScape - STAGE 1	DETAIL PLAN - TOWN SQUARE	A1	12535413-L701	0



# TOWN SQUARE DESIGN PROPOSAL

Attachments for Item 9.3

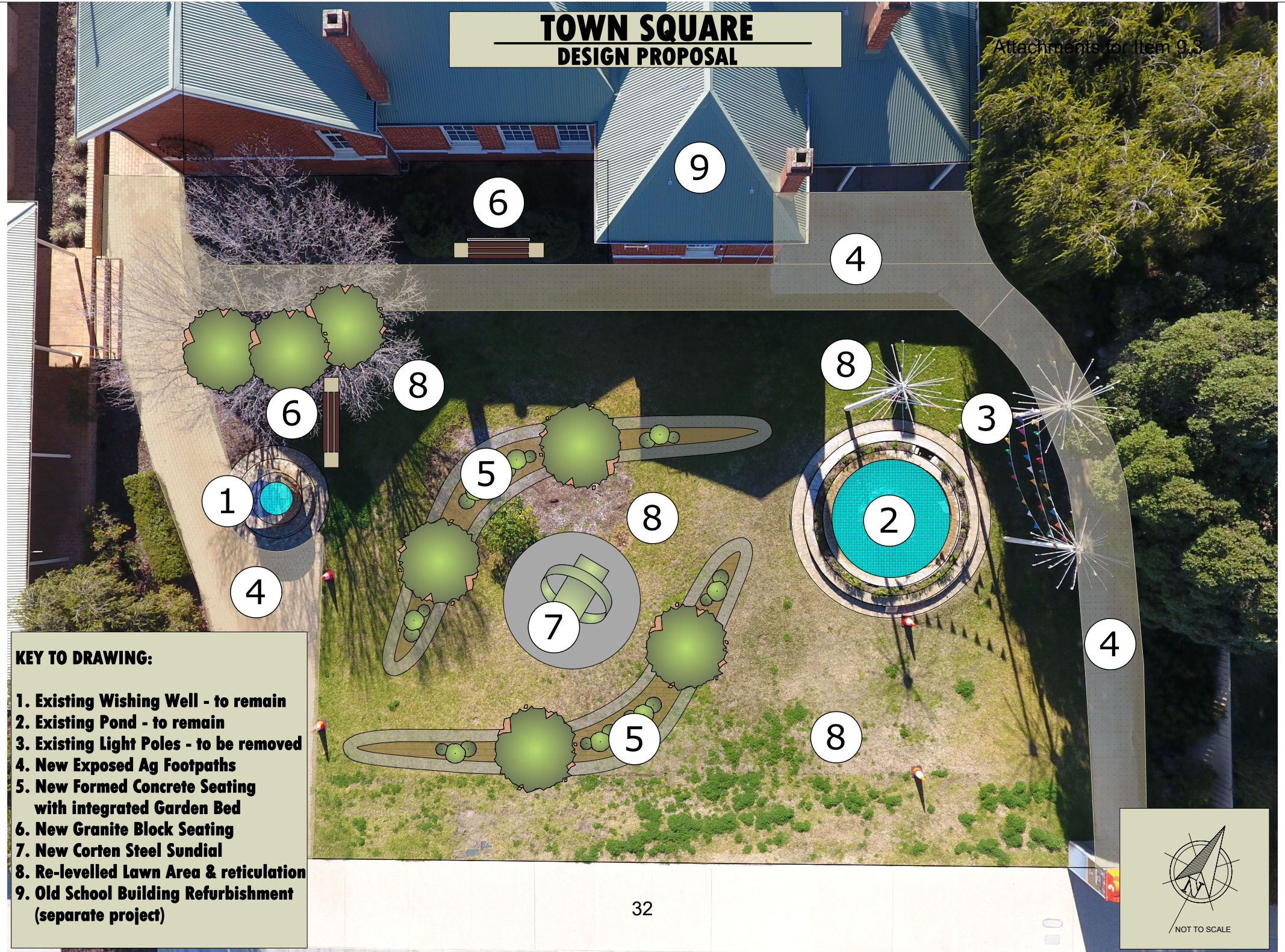

## KEY TO DRAWING:

- 1. Existing Wishing Well - to remain
- 2. Existing Pond - to remain
- 3. Existing Light Poles - to be removed
- 4. New Exposed Ag Footpaths
- 5. New Formed Concrete Seating with integrated Garden Bed
- 6. New Granite Block Seating
- 7. New Corten Steel Sundial
- 8. Re-levelled Lawn Area & reticulation
- 9. Old School Building Refurbishment (separate project)

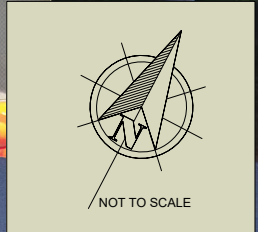



## TOWN SQUARE – DETAILED DESIGN ELEMENTS

### Typical Cross Sections – Formed Concrete Seating & Integrated Garden Bed:

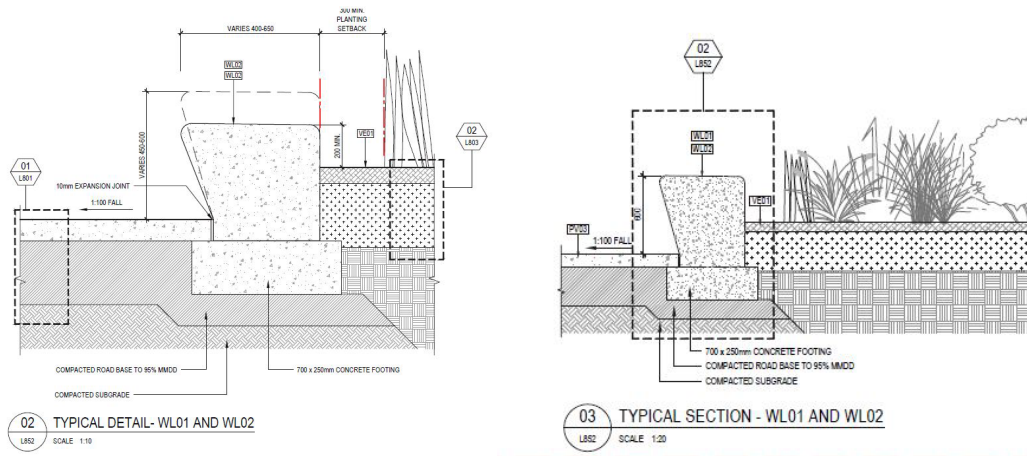

### Granite Block Seating:

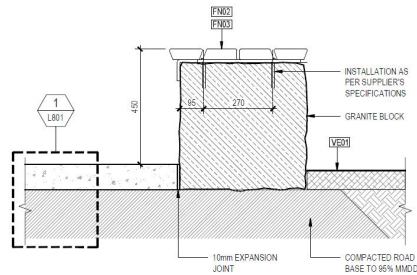
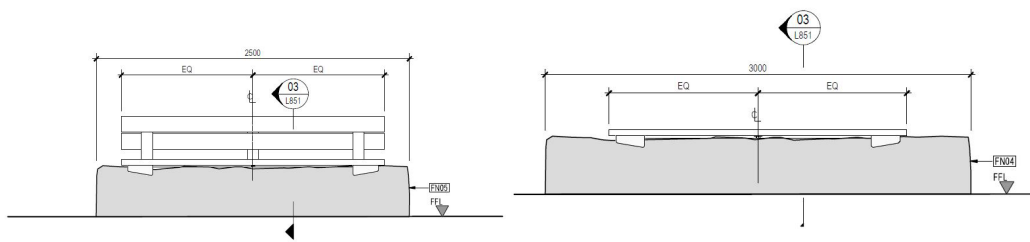

- NOTES:
- TIMBER SLATS TO BE OILED SPOTTED GUM - 130mm x 30mm.
  - ACCEPTABLE TIMBER OIL: "OUTER"
  - STEEL FINISH AND COLOUR: Powder coat Monument Dulux
  - Durability Monument: M301 2609066
  - STRUCTURAL FRAMEWORK EX. 9068 FLAT.
  - TIMBER SLATS TO BE FASTENED TO FRAME USING 304 S.S. SQUARE DRIVE PANO HEAD SCREWS - 149 x 52mm.

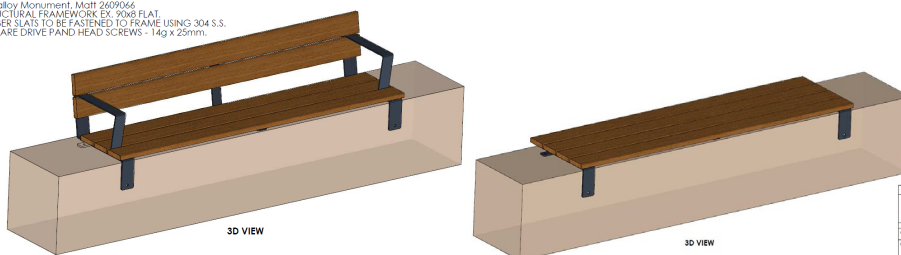

**Proposed Sundial Prototype:**

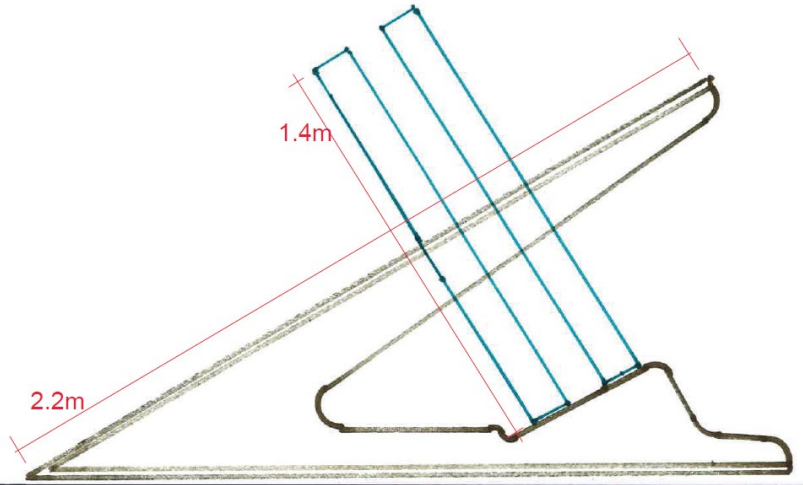

**Cross Section View**

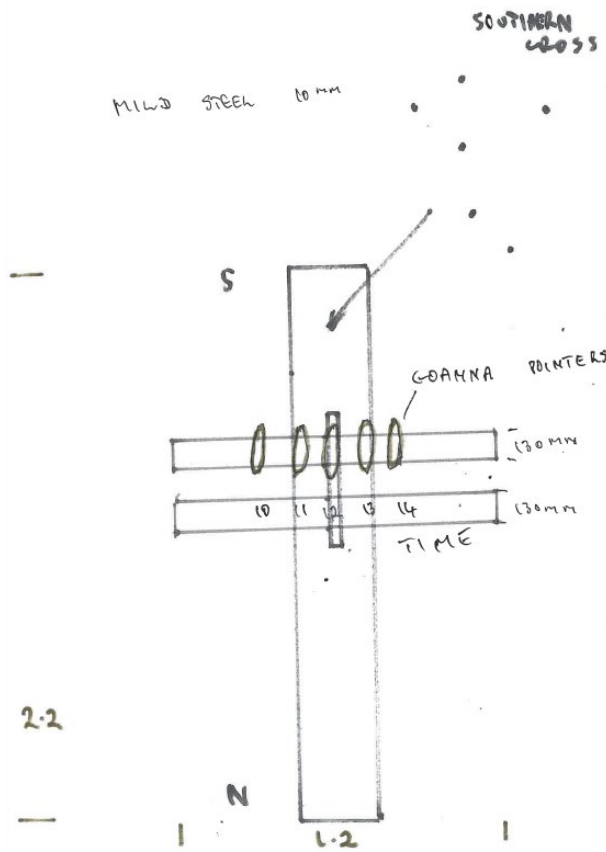

**Plan View**



**Perspective View**

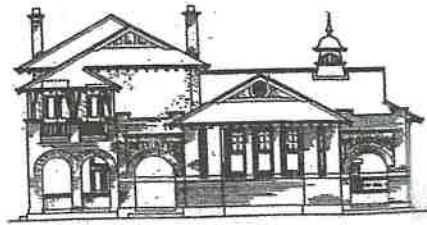

Post Office C1910

Attachments for Item 9.3  
**Beverley Post News and Gifts**  
128-130 Vincent Street  
**BEVERLEY WA 6304**



06 December 2023

**Shire of Beverley**  
P.O. Box 20  
Beverley WA 6304

<b>SHIRE OF BEVERLEY</b>		
07 DEC 2023		
FILE REF:		
<input type="checkbox"/> CEO	<input type="checkbox"/> SP	<input type="checkbox"/> TO
<input type="checkbox"/> DCEO	<input type="checkbox"/> EHOBS	<input type="checkbox"/> PO
<input type="checkbox"/> MOW	<input type="checkbox"/> CESM	<input type="checkbox"/> .....

**Old School Building Refurbishment**

Thank you for the opportunity to comment on the “Old School Building Refurbishment”.

1. We preferred the plans for the “front lawn” area of the Old School Building, original presented at the time of the implementation of the “Street Scape” upgrade, but understand that money constraints have affected the ability to move forward on this blueprint.

**We would favour a holding off on the development of this area until the original design can be funded. The Shire has gone upmarket on our street design and feel that what is currently proposed for the lawn area is not of the same standard and would detract from what is already in place.**

2. During the refurbishment, can we request that the Shire **trim the New Zealand Christmas tree that overhangs into the yard of the Post Office Quarters**. We don't want the tree removed as it is a sanctuary for a lot of birds. A reduction of 3m would suffice for safety and health issues.

It currently sits about 4m distant from the upper story of the Quarters and the tree itself has a lot of dead wood. Our problem is that the Fire Brigade has told us that they do not have the facility to extinguish a fire on our second storey and as there is only one access point from the bedrooms on the second story to the ground, we are concerned not only for our safety, but also the building if a fire does occur in the canopy of this tree.

If you wish to discuss any of the points above or for any further information, please do not hesitate to contact either John or Vicky Fregon on the above contacts.

Best wishes

**John and Vicky Fregon**  
Beverley Post News and Gifts

## **10. BUILDING SERVICES & ENVIRONMENTAL HEALTH SERVICES**

Nil



## **11. FINANCE**

### **11.1 Monthly Financial Report**

---

<b>Submission To:</b>	<b>Ordinary Council Meeting 19 December 2023</b>
<b>Report Date:</b>	<b>12 December 2023</b>
<b>Applicant:</b>	<b>N/A</b>
<b>File Reference:</b>	<b>N/A</b>
<b>Author and Position:</b>	<b>S.K. Marshall, Deputy Chief Executive Officer</b>
<b>Previously Before Council:</b>	<b>N/A</b>
<b>Disclosure(s) Of Interest:</b>	<b>Nil</b>
<b>Attachments:</b>	<b>November 2023 Financial Reports</b>

---

#### **SUMMARY**

Council to consider accepting the financial report for the period ending 30 November 2023.

#### **BACKGROUND**

There is a statutory requirement that the Local Government is to prepare, each month, a statement of financial activity reporting on sources and applications of its funds and to present the statement to Council.

Council adopted a budget variance reporting parameter of 10% on budgeted items of \$10,000 or greater at the July 2023 Ordinary Meeting, item 11.4.

#### **COMMENT**

The monthly financial reports for the period ending 30 November 2023 have been provided and include:

- Financial Activity Statement by Nature;
- Statement of Net Current Assets;
- Statement of Financial Position; and
- Investment of Surplus Funds Report.

#### **STATUTORY ENVIRONMENT**

Section 6.4(1) of the *Local Government Act* provides that a local government is to prepare an annual financial report for the preceding financial year and such other financial reports as are prescribed.

Regulation 34 of the *Local Government (Financial Management) Regulations* requires a Statement of Financial Activity to be prepared each month which is to contain the following details:

- (a) annual budget estimates;
- (b) budget estimates to the end of the month;
- (c) actual amount of expenditure and revenue;
- (d) material variances between comparable amounts in (b) and (c) above; and
- (e) the net current assets at the end of the month to which the statement relates (i.e. surplus / (deficit) position).

The Statement is to be accompanied by:

- (a) explanation of the composition of net current assets, less committed assets and restricted assets;

- (b) explanation of the material variances; and
- (c) such other information considered relevant by the local government.

### FINANCIAL IMPLICATIONS

All revenue and expenditure, unless disclosed in the notes to material variances, are as per the 2023/24 Budget.

### STRATEGIC IMPLICATIONS

Strategic Pillar: 4. Civic Leadership  
Strategic Priorities: 4.2 Continuous organisational improvement  
4.3 Responsible planning

### POLICY IMPLICATIONS

AF004 – Investing Surplus Funds

### RISK IMPLICATIONS

It is a requirement of the *Local Government (Financial Management) Regulations 1996* that a Statement of Financial Activity is prepared within two months of the end of the reporting period. This report mitigates the risk of non-compliance.

Consequence	Insignificant	Minor	Moderate	Major	Catastrophic
<b>Likelihood</b>					
Almost Certain	Medium	High	High	Severe	Severe
Likely	Low	Medium	High	High	Severe
Possible	Low	Medium	Medium	High	High
Unlikely	Low	Low	Medium	Medium	High
Rare	Low	Low	Low	Low	Medium

Risk Rating	Action
Low	Monitor for ongoing improvement.
Medium	Comply with risk reduction measures to keep risk as low as reasonably practical.
High	Review the risk and take additional measures to ensure risk is low as reasonably achievable.
Severe	Unacceptable risk level, reduction measures must be introduced before proceeding.

### VOTING REQUIREMENTS

Simple Majority

### OFFICER'S RECOMMENDATION

That the monthly financial report for the month of November 2023 be accepted and material variances be noted.

**SHIRE OF BEVERLEY  
STATEMENT OF FINANCIAL ACTIVITY BY NATURE  
FOR THE PERIOD ENDING  
30 November 2023**

Description	Budget 2023/24	YTD Budget 2023/24	YTD Actual 2023/24	YTD Variance	Notes To Material Variances
<b>Operating Revenue</b>					
Rates	3,241,771.00	3,237,271.00	3,251,353.18	14,082.18	Rates Discount expense \$16,064 lower than anticipated. Rates raised (\$1,976) lower than anticipated.
Operating Grants, Subsidies and Contributions	569,235.00	241,411.00	330,264.52	88,853.52	Workers compensation insurance reimbursement \$48,262 and Financial Assistance and Road Grants \$32,753 higher than anticipated. Library grant Encouraging Promising Practices \$4,950 additional grant funding received offset by program expenditure.
Profit On Asset Disposal	27,900.00	10,900.00	6,386.71	(4,513.29)	
Service Charges	0.00	0.00	0.00	0.00	
Fees & Charges	798,854.00	487,818.00	490,661.65	2,843.65	
Interest Earnings	166,267.00	55,105.00	54,318.59	(786.41)	
Other Revenue	592,112.00	87,500.00	83,637.43	(3,862.57)	
Non-Operating Grants, Subsidies and Contributions	6,597,684.00	181,936.00	179,210.73	(2,725.27)	
<b>Total Operating Revenue</b>	<b>11,993,823.00</b>	<b>4,301,941.00</b>	<b>4,395,832.81</b>	<b>93,891.81</b>	
<b>Operating Expenditure</b>					
Employee Costs	(2,448,524.00)	(926,615.00)	(1,017,095.75)	(90,480.75)	Workers Compensation expense (\$75,163) greater than expected offset by insurance reimbursement. Avondale staff expenses (\$14,145) greater than expected offset by National Trust contribution.
Materials & Contracts	(2,275,089.00)	(753,529.00)	(758,431.74)	(4,902.74)	
Utilities	(222,075.00)	(85,581.00)	(87,949.51)	(2,368.51)	
Depreciation On Non-Current Assets	(2,455,402.00)	(1,023,050.00)	(1,121,058.03)	(98,008.03)	Depreciation expense higher than anticipated due to 22/23 Infrastructure revaluation.
Interest Expenses	(67,594.00)	(7,212.00)	(7,679.92)	(467.92)	22/23 Accrual Reversals.
Insurance Expenses	(286,484.00)	(285,306.00)	(286,064.79)	(758.79)	
Other Expenditure	(84,001.00)	(47,632.00)	(46,765.41)	866.59	
Loss On Asset Disposal	(6,300.00)	(2,285.00)	0.00	2,285.00	
Loss on Revaluation of Non-Current Assets	0.00	0.00	0.00	0.00	
<b>Total Operating Expenditure</b>	<b>(7,845,469.00)</b>	<b>(3,131,210.00)</b>	<b>(3,325,045.15)</b>	<b>(193,835.15)</b>	
<b>Net Operating</b>	<b>4,148,354.00</b>	<b>1,170,731.00</b>	<b>1,070,787.66</b>	<b>(99,943.34)</b>	
<b>Capital Income</b>					
Self Supporting Loan - Principal Repayment	0.00	0.00	0.00	0.00	
Proceeds from Sale of Assets	264,400.00	45,400.00	40,454.54	(4,945.46)	
New Loan Raised	1,000,000.00	0.00	0.00	0.00	
<b>Total Capital Income</b>	<b>1,264,400.00</b>	<b>45,400.00</b>	<b>40,454.54</b>	<b>(4,945.46)</b>	

**SHIRE OF BEVERLEY  
STATEMENT OF FINANCIAL ACTIVITY BY NATURE  
FOR THE PERIOD ENDING  
30 November 2023**

Description	Budget 2023/24	YTD Budget 2023/24	YTD Actual 2023/24	YTD Variance	Notes To Material Variances
<b>Capital Expenditure</b>					
Land and Buildings	(3,343,000.00)	(34,500.00)	(36,755.24)	(2,255.24)	
Plant and Equipment	(637,500.00)	(92,000.00)	(91,315.02)	684.98	
Office Furniture and Equipment	(33,000.00)	(33,000.00)	(26,455.33)	6,544.67	
Road Construction	(5,382,773.00)	(490,415.00)	(490,054.48)	360.52	AGRN1061 Storm Damage Project Management expenses.
Other Infrastructure	(2,041,855.00)	(117,000.00)	(117,616.40)	(616.40)	
Land Under Control	0.00	0.00	0.00	0.00	
Leases	(6,837.00)	(6,837.00)	(6,836.60)	0.40	
Loans - Principal Repayments	(117,135.00)	(45,481.00)	(45,481.23)	(0.23)	
<b>Total Capital Expenditure</b>	<b>(11,562,100.00)</b>	<b>(819,233.00)</b>	<b>(814,514.30)</b>	<b>4,718.70</b>	
<b>Net Capital</b>	<b>(10,297,700.00)</b>	<b>(773,833.00)</b>	<b>(774,059.76)</b>	<b>(226.76)</b>	
<b>Adjustments</b>					
Depreciation Written Back	2,455,402.00	1,023,050.00	1,121,058.03	98,008.03	Depreciation expense higher than anticipated due to 22/23 Infrastructure revaluation.
Movement in Leave Reserve Cash Balance	0.00	0.00	1,784.68	1,784.68	
Movement in Non-Current Loan Repayments	0.00	0.00	0.00	0.00	
Movement in Non-Current SSL Income	0.00	0.00	0.00	0.00	
Movement in Non-Current Lease Repayments	0.00	0.00	0.00	0.00	
Movement in Non-Current Investments	0.00	0.00	0.00	0.00	
Movement in Non-Current LSL Provision	0.00	0.00	0.00	0.00	
Movement in Non-Current Deferred Pensioner Rates	0.00	0.00	0.00	0.00	
(Profit)/Loss on Disposal of Assets Written Back	(21,600.00)	(10,900.00)	(6,386.71)	4,513.29	Profit on disposal lower than anticipated.
Loss on Revaluation of Non-Current Assets Written Back	0.00	0.00	0.00	0.00	
Rounding	0.00	0.00	0.00	0.00	
<b>Add Funding From</b>					
Transfer (To)/From Reserves	1,089,240.00	(28,000.00)	(28,144.53)	(144.53)	
Opening Surplus/(Deficit)	2,626,304.00	2,626,304.00	2,626,304.21	0.21	
<b>Total Adjustments</b>	<b>6,149,346.00</b>	<b>3,610,454.00</b>	<b>3,714,615.68</b>	<b>104,161.68</b>	
<b>CLOSING SURPLUS/(DEFICIT)</b>	<b>0.00</b>	<b>4,007,352.00</b>	<b>4,011,343.58</b>	<b>3,991.58</b>	

**SHIRE OF BEVERLEY  
STATEMENT OF NET CURRENT ASSETS  
FOR THE PERIOD ENDING  
30 November 2023**

Description	Actual 2022/23	YTD Actual 2023/24
<b>Current Assets</b>		
Cash at Bank	1,627,645.56	692,268.23
Cash - Unrestricted Investments	1,271,666.73	3,324,666.15
Cash - Restricted Reserves	2,280,553.31	2,308,697.84
Cash on Hand	700.00	700.00
Accounts Receivable	663,428.06	1,036,574.35
Inventory - Fuel	9,932.34	15,060.29
<b>Total Current Assets</b>	<b>5,853,926.00</b>	<b>7,377,966.86</b>
<b>Current Liabilities</b>		
Accounts Payable	(652,689.79)	(765,331.43)
Loan Liability - Current	(117,135.16)	(71,653.93)
Lease Liability - Current	(6,836.60)	(6,836.60)
Annual Leave Liability - Current	(234,280.71)	(234,280.71)
Long Service Leave Liability - Current	(197,874.12)	(197,874.12)
<b>Total Current Liabilities</b>	<b>(1,208,816.38)</b>	<b>(1,275,976.79)</b>
<b>Adjustments</b>		
Less Restricted Reserves	(2,280,553.31)	(2,308,697.84)
Add Leave Reserves - Cash Backed	144,612.74	146,397.42
Add Loan Principal Expense	117,135.16	71,653.93
<b>Total Adjustments</b>	<b>(2,018,805.41)</b>	<b>(2,090,646.49)</b>
<b>NET CURRENT ASSETS</b>	<b>2,626,304.21</b>	<b>4,011,343.58</b>

**SHIRE OF BEVERLEY  
STATEMENT OF FINANCIAL POSITION  
AS AT  
30 November 2023**

Description	Actual 2022/23	YTD Actual 2023/24	Movement
<b>Current Assets</b>			
Cash and Cash Equivalents	5,180,565.60	6,326,332.22	1,145,766.62
Accounts Receivable	465,875.06	866,340.35	400,465.29
Contract Asset - Current	197,553.00	170,234.00	(27,319.00)
Prepaid Expenses	0.00	0.00	0.00
Self Supporting Loan - Current	0.00	0.00	0.00
Inventory	9,932.34	15,060.29	5,127.95
<b>Total Current Assets</b>	<b>5,853,926.00</b>	<b>7,377,966.86</b>	<b>1,524,040.86</b>
<b>Current Liabilities</b>			
Accounts Payable	(527,898.79)	(318,424.43)	209,474.36
Contract Liability - Current	(124,791.00)	(446,907.00)	(322,116.00)
Loan Liability - Current	(117,135.16)	(71,653.93)	45,481.23
Lease Liability - Current	(6,836.60)	0.00	6,836.60
Annual Leave Liability - Current	(234,280.71)	(234,280.71)	0.00
Long Service Leave Liability - Current	(197,874.12)	(197,874.12)	0.00
Doubtful Debts	0.00	0.00	0.00
<b>Total Current Liabilities</b>	<b>(1,208,816.38)</b>	<b>(1,269,140.19)</b>	<b>(60,323.81)</b>
<b>Non-Current Assets</b>			
Non-Current Debtors	161,234.90	161,234.90	0.00
Non-Current Investments	61,117.14	61,117.14	0.00
Land and Buildings	29,149,181.97	28,879,086.08	(270,095.89)
Plant and Equipment	2,369,732.12	2,318,183.74	(51,548.38)
Furniture and Equipment	98,756.30	113,290.30	14,534.00
Infrastructure	140,931,963.00	140,846,143.88	(85,819.12)
Self Supporting Loan - Non Current	0.00	0.00	0.00
<b>Total Non-Current Assets</b>	<b>172,771,985.43</b>	<b>172,379,056.04</b>	<b>(392,929.39)</b>
<b>Non-Current Liabilities</b>			
Loan Liability - Non Current	(2,001,137.54)	(2,001,137.54)	0.00
Lease Liability - Non Current	0.00	0.00	0.00
Annual Leave - Non Current	0.00	0.00	0.00
Long Service Leave Liability - Non Current	(52,492.51)	(52,492.51)	0.00
<b>Total Non Current Liabilities</b>	<b>(2,053,630.05)</b>	<b>(2,053,630.05)</b>	<b>0.00</b>
<b>Net Assets</b>	<b>175,363,465.00</b>	<b>176,434,252.66</b>	<b>1,070,787.66</b>

**SHIRE OF BEVERLEY  
STATEMENT OF FINANCIAL POSITION  
AS AT  
30 November 2023**

Description	Actual 2022/23	YTD Actual 2023/24	Movement
<b>Equity</b>			
Accumulated Surplus	(47,528,324.75)	(48,570,967.88)	(1,042,643.13)
Reserves - Cash Backed	(2,280,553.31)	(2,308,697.84)	(28,144.53)
Reserve - Revaluations	(125,554,586.94)	(125,554,586.94)	0.00
<b>Total Equity</b>	<b>(175,363,465.00)</b>	<b>(176,434,252.66)</b>	<b>(1,070,787.66)</b>

<b>SHIRE OF BEVERLEY</b>						
<b>INVESTMENT OF SURPLUS FUNDS</b>						
<b>AS AT 30 November 2023</b>						
<b>Account #</b>	<b>Account Name</b>	<b>Amount Invested (\$)</b>		<b>Term</b>	<b>Interest Rate</b>	<b>Maturation</b>
<b>4320546</b>	<b>Reserve Funds Bendigo</b>					
	Long Service Leave	146,397.42				
	Airfield Emergency	42,057.59				
	Plant	102,484.01				
	Emergency Services	30,079.27				
	Building	590,835.19				
	Recreation Ground	612,125.44				
	Cropping Committee	178,190.88				
	Community Bus	41,409.26				
	Infrastructure	225,617.01				
	Senior Housing	234,541.37				
	Avondale Mach Museum	63,169.46				
	ITC Renewal Reserve	41,790.94	2,308,697.84	5 mnths	4.70%	22/02/2024
<b>4465609</b>	<b>Term Deposit Bendigo</b>	252,864.02		4 mnths	5.00%	8/12/2023
<b>4473950</b>	<b>Term Deposit Bendigo</b>	500,000.00		5 mnths	5.10%	17/01/2024
<b>4545104</b>	<b>Term Deposit Bendigo</b>	306,358.24		4 mnths	4.71%	23/02/2024
<b>4579678</b>	<b>Term Deposit Bendigo</b>	515,443.89		6 mnths	4.96%	27/05/2024
<b>4481942</b>	<b>Term Deposit Bendigo</b>	500,000.00		6 mnths	5.15%	23/02/2024
<b>4481943</b>	<b>Term Deposit Bendigo</b>	500,000.00		7 mnths	5.15%	25/03/2024
<b>4481944</b>	<b>Term Deposit Bendigo</b>	250,000.00		8 mnths	5.15%	24/04/2024
<b>4527499</b>	<b>Term Deposit Bendigo</b>	500,000.00	3,324,666.15	6 mnths	4.72%	8/04/2024
	<b>Total</b>		<b>5,633,363.99</b>			



## **11.2 Accounts Paid by Authority**

---

<b>Submission To:</b>	<b>Ordinary Council Meeting 19 December 2023</b>
<b>Report Date:</b>	<b>13 December 2023</b>
<b>Applicant:</b>	<b>N/A</b>
<b>File Reference:</b>	<b>N/A</b>
<b>Author and Position:</b>	<b>S.K. Marshall, Deputy Chief Executive Officer</b>
<b>Previously Before Council:</b>	<b>N/A</b>
<b>Disclosure(s) Of Interest:</b>	<b>Nil</b>
<b>Attachments:</b>	<b>November 2023 List of Reports</b>

---

### **SUMMARY**

Council to consider authorising the payment of accounts.

### **BACKGROUND**

The following list represents accounts paid by authority for the month of November 2023.

### **COMMENT**

Unless otherwise identified, all payments have been made in accordance with Council's 2023/24 Budget.

### **STATUTORY ENVIRONMENT**

Regulation 12 of the *Local Government (Financial Management) Regulations* provides that:

- (1) A payment may only be made from the municipal fund or the trust fund —
  - (a) if the local government has delegated to the CEO the exercise of its power to make payments from those funds — by the CEO; or
  - (b) otherwise, if the payment is authorised in advance by a resolution of the council.
- (2) The council must not authorise a payment from those funds until a list prepared under regulation 13(2) containing details of the accounts to be paid has been presented to the council.

Regulation 13 of the *Local Government (Financial Management) Regulations* provides that:

- (1) If the local government has delegated to the CEO the exercise of its power to make payments from the municipal fund or the trust fund, a list of accounts paid by the CEO is to be prepared each month showing for each account paid since the last such list was prepared —
  - (a) the payee's name;
  - (b) the amount of the payment;
  - (c) the date of the payment; and
  - (d) sufficient information to identify the transaction.
- (2) A list of accounts for approval to be paid is to be prepared each month showing —
  - (a) for each account which requires council authorisation in that month —
    - (i) the payee's name;
    - (ii) the amount of the payment; and
    - (iii) sufficient information to identify the transaction;

and

- (b) the date of the meeting of the Council to which the list is to be presented.
- (3) A list prepared under sub regulation (1) or (2) is to be —
  - (a) presented to the Council at the next ordinary meeting of the council after the list is prepared; and
  - (b) recorded in the minutes of that meeting.

### FINANCIAL IMPLICATIONS

Unless otherwise identified, all payments have been made in accordance with Council's 2023/24 Budget.

### STRATEGIC IMPLICATIONS

Strategic Pillar: 4. Civic Leadership  
 Strategic Priorities: 4.2 Continuous organisational improvement  
 4.3 Responsible planning

### POLICY IMPLICATIONS

Authority to Purchase – All acquisitions should be in accordance with budget provisions or to a maximum specified cost.

### RISK IMPLICATIONS

Failure to present a detailed listing in the prescribed form would result in non-compliance *Local Government (Financial Management) Regulations 1996*, this report mitigates the risk of non-compliance.

Consequence	Insignificant	Minor	Moderate	Major	Catastrophic
<b>Likelihood</b>					
Almost Certain	Medium	High	High	Severe	Severe
Likely	Low	Medium	High	High	Severe
Possible	Low	Medium	Medium	High	High
Unlikely	Low	Low	Medium	Medium	High
Rare	Low	Low	Low	Low	Medium

Risk Rating	Action
Low	Monitor for ongoing improvement.
Medium	Comply with risk reduction measures to keep risk as low as reasonably practical.
High	Review the risk and take additional measures to ensure risk is low as reasonably achievable.
Severe	Unacceptable risk level, reduction measures must be introduced before proceeding.

### VOTING REQUIREMENTS

Simple Majority

## OFFICER'S RECOMMENDATION

That the List of Accounts as presented, be received:

### November 2023:

#### (1) Municipal Fund – Account 016-540 259 838 056

##### **Cheque vouchers**

14 November 2023 1902-1903 (2) \$ 1,033.05 (authorised by CEO S Gollan and DCEO S Marshall)

**Total of cheque vouchers for November 2023 incl \$ 1,033.05 previously paid**

##### **EFT vouchers**

08 November 2023 EFT 1-37 (37) \$ 66,222.73 (authorised by DCEO Pres D White and Cr D Davis)

14 November 2023 EFT 9840-9879 (40) \$ 140,951.93 (authorised by CEO S Gollan and DCEO S Marshall)

04 November 2023 EFT 9880-9880 (1) \$ 231.00 (authorised by CEO S Gollan and DCEO S Marshall)

14 November 2023 EFT 9882-9918 (37) \$ 493,758.69 (authorised by CEO S Gollan and DCEO S Marshall)

21 November 2023 EFT 1-37 (37) \$ 62,743.02 (authorised by DCEO S Marshall and Pres D White)

**Total of EFT vouchers for November 2023 incl \$ 763,907.37 previously paid**

#### (2) Trust Fund – Account 016-259 838 128

##### **Cheque vouchers**

Nil vouchers

**Total of cheque vouchers for November 2023 incl \$ 0.00 previously paid.**

##### **EFT vouchers**

14 November 2023 EFT 9836-9839 (4) \$ 400.00 (authorised by CEO S Gollan and DCEO S Marshall)

**Total of EFT vouchers for November 2023 incl \$ 400.00 previously paid.**

**(3) Direct Debit Payments totalling \$ 90,982.45 previously paid.**

**(4) Credit Card Payments totalling \$ 2,122.65 previously paid.**

SHIRE OF BEVERLEY

**CHEQUE DETAIL - Municipal and Trust Accounts - NOVEMBER 2023**

TYPE	NUM	DATE	PAYEE	DETAILS	AMT PAID	TOTALS
Cheque #	1902	14-Nov-2023	ACMA - Australian Communications & I	Land Mobile Appart Lic Renewal Lic 252879/1 Exp: 10 Dec 2024 Bev North East Brigad	(983.00)	
Cheque #	1903	14-Nov-2023	Water Corporation	Water use - Mens Shed (Vincent St) - Service Fees: Nov - Dec 23	(50.05)	(1,033.05)
EFT Pymt	EFT 9840	14-Nov-2023	ASB Marketing P/L	Uniforms: Admin Staff	(439.29)	
EFT Pymt	EFT 9841	14-Nov-2023	ATO - Australian Tax Office	2023-10 Oct BAS Obligation	(11,555.00)	
EFT Pymt	EFT 9842	14-Nov-2023	Air and Power	PSP99 Sundry plant: Depot air compressor service	(563.75)	
EFT Pymt	EFT 9843	14-Nov-2023	Australia Post	2023-10 Oct Postage	(411.69)	
EFT Pymt	EFT 9844	14-Nov-2023	Avon Trading Pty Ltd	2023-10 Oct Hardware Purchases	(951.71)	
EFT Pymt	EFT 9845	14-Nov-2023	Avon Valley Windscreens	Various plant: Windscreen replacement and/or repairs	(3,245.00)	
EFT Pymt	EFT 9846	14-Nov-2023	Avon Waste	2,076 Bin Collection FE 27 Oct, 03 Nov 23 inc Recycling Bins & 4 x Recycling Collectio	(5,503.99)	
EFT Pymt	EFT 9847	14-Nov-2023	BOC Limited	2023-10 Oct Cylinder Rental: Medical oxygen C size	(6.92)	
EFT Pymt	EFT 9848	14-Nov-2023	BSL - DMIRS Dept Mines, Industry Reg	2023-10 Oct Collections x 7 (Lics 23/24: 09, 12, 13, 14, 15, 16, 17)	(1,152.47)	
EFT Pymt	EFT 9849	14-Nov-2023	Barrie Grant Johnston	Relief Maintenance: 25 Oct - 07 Nov 2023 (72.0 hrs)	(3,600.00)	
EFT Pymt	EFT 9850	14-Nov-2023	Beverley Bakehouse and Cafe	DAIP community workshops - 02 Nov 2023: Refreshments	(33.10)	
EFT Pymt	EFT 9851	14-Nov-2023	Beverley Dome Fuel and Hire (BDF)	7,357 L Diesel @ \$1.9598/L GST inc	(14,418.24)	
EFT Pymt	EFT 9852	14-Nov-2023	Beverley Electrical Services - BES	Various bldgs: Electrical repairs	(1,924.62)	
EFT Pymt	EFT 9853	14-Nov-2023	Beverley Gas and Plumbing Services -	Swim Pool: Toilet replacement	(1,245.87)	
EFT Pymt	EFT 9854	14-Nov-2023	Beverley Post News and Gifts (BPNG)	2023-10 Oct Newspaper Subscription & Stationery Purchases	(607.50)	
EFT Pymt	EFT 9855	14-Nov-2023	Beverley Steel Fabrication	BE036 (PLDR03): Repairs	(62.67)	
EFT Pymt	EFT 9856	14-Nov-2023	Beverley Supermarket & Liquor (IGA)	2023-10 Oct Purchases	(577.62)	
EFT Pymt	EFT 9857	14-Nov-2023	Bluejay Ag Solutions	2023-11 Nov (Ed 469) Compilation of the Blarney	(1,000.00)	
EFT Pymt	EFT 9858	14-Nov-2023	Bunnings Building Supplies P/L	Various bldgs: Hardware purchases	(33.67)	
EFT Pymt	EFT 9859	14-Nov-2023	C and D Cutri	BRG-0723 Westdale Rd: Emergency repairs	(35,200.00)	
EFT Pymt	EFT 9860	14-Nov-2023	Cannon Hygiene Australia Pty Ltd	2023/24 Annual Hygiene Servicing	(2,879.75)	
EFT Pymt	EFT 9861	14-Nov-2023	Contract Aquatic Services - CAS	1 of 5 (Nov 2023) install of Contract Management Fee for 2023/24 swim year	(15,400.00)	
EFT Pymt	EFT 9862	14-Nov-2023	Country Copiers Northam (DA Gardner	Copier Charges: 10 Oct - 01 Nov 2023	(367.45)	
EFT Pymt	EFT 9863	14-Nov-2023	Dept of Fire & Emergency Services (DF	Various bldgs: 2023-24 ESL Levy	(3,491.73)	

SHIRE OF BEVERLEY

**CHEQUE DETAIL - Municipal and Trust Accounts - NOVEMBER 2023**

TYPE	NUM	DATE	PAYEE	DETAILS	AMT PAID	TOTALS
EFT Pymt	EFT 9864	14-Nov-2023	IRIS Consulting Group Pty Ltd	Archiving Records Training & Support	(3,960.00)	
EFT Pymt	EFT 9865	14-Nov-2023	Karl Ernest Green	Rates refund (Credit bal) for Ass 51549 - 551 Butchers Road, Dale 6304	(1,800.00)	
EFT Pymt	EFT 9866	14-Nov-2023	Marketforce Pty Ltd - Omnicom Media	Old School Bldg - Civic Centre Upgrade: Tender advertising for design & construction	(899.13)	
EFT Pymt	EFT 9867	14-Nov-2023	McIntosh and Son WA	BE021 (PLDR05): Repairs	(5,119.13)	
EFT Pymt	EFT 9868	14-Nov-2023	Michael Wilson	2023-11 Nov (Ed 469) Blarney: Printing & delivery	(250.00)	
EFT Pymt	EFT 9869	14-Nov-2023	Old Skool Mechanical	BE030 (PBH02): Repairs	(1,705.00)	
EFT Pymt	EFT 9870	14-Nov-2023	Perth Regional Tourism Organisation	In 1/5th contribution to reprint Avon Valley Tourism publication	(1,518.00)	
EFT Pymt	EFT 9871	14-Nov-2023	RJ Jas - All Mechanical and Electronics	Various plant: Services, Parts & Repairs	(2,451.80)	
EFT Pymt	EFT 9872	14-Nov-2023	Reap What You Sow	2023-10 Oct Gym Inductions x 1	(25.00)	
EFT Pymt	EFT 9873	14-Nov-2023	Resonline Pty Ltd	2023-10 Oct Room Manager Online Booking System Subscription	(242.00)	
EFT Pymt	EFT 9874	14-Nov-2023	The Red Vault	Council Meet - 31 Oct 2023: Catering	(260.00)	
EFT Pymt	EFT 9875	14-Nov-2023	Total Packaging (WA) Pty Ltd	Various: Dog poo bags & disposal units	(171.60)	
EFT Pymt	EFT 9876	14-Nov-2023	Vanessa Underhay	Onsite Cabins: Refund due to cancelled booking	(290.00)	
EFT Pymt	EFT 9877	14-Nov-2023	West Coast Shade Pty Ltd	LBS2406 - Swim Pool Shade replacement	(11,506.00)	
EFT Pymt	EFT 9878	14-Nov-2023	West Pest WA	Various Bldgs: Pest Control Spraying	(5,830.00)	
EFT Pymt	EFT 9879	14-Nov-2023	York Laundromat	30 Oct - 02 Nov 2023 Onsite Cabins Laundry fees	(252.23)	(140,951.93)
EFT Pymt	EFT 9880	21-Nov-2023	QEP Aust Pty Ltd (Aust Flooring Suppli	Cornerstone Visitor Centre & Museum: Carpet tiles	(231.00)	(231.00)
EFT Pymt	EFT 9882	24-Nov-2023	AMD Chartered Accountants	2023 Deferred Rates; RTR2; Loc Rds & Com Infrastructure program acquittal audits to :	(5,665.00)	
EFT Pymt	EFT 9883	24-Nov-2023	Agriparts and Repairs	Fire units: Hose parts for water transfer	(789.75)	
EFT Pymt	EFT 9884	24-Nov-2023	Arrow Bronze	Niche Walls: 2 x Single plaques	(591.42)	
EFT Pymt	EFT 9885	24-Nov-2023	Avon Waste	2,076 Bin Collection FE 10, 17 Nov 23 inc Recycling Bins & 4 x Recycling Collections	(5,503.99)	
EFT Pymt	EFT 9886	24-Nov-2023	Barrie Grant Johnston	Relief Maintenance: 08 - 21 Nov 2023 (72.0 hrs)	(3,600.00)	
EFT Pymt	EFT 9887	24-Nov-2023	Beverley Dome Fuel and Hire (BDF)	4,000 L Diesel @ \$1.8635/L GST incl	(7,454.00)	
EFT Pymt	EFT 9888	24-Nov-2023	Blacker Tyres (Perth) Pty Ltd	BE036 (PLDR03): Tyre purchase	(2,200.00)	
EFT Pymt	EFT 9889	24-Nov-2023	Bunnings Building Supplies P/L	Various bldgs: Hardware purchases	(127.00)	
EFT Pymt	EFT 9890	24-Nov-2023	Complete Office Supplies Pty Ltd	(COS 2023-11 Nov Stationery Order	(720.88)	

SHIRE OF BEVERLEY

**CHEQUE DETAIL - Municipal and Trust Accounts - NOVEMBER 2023**

TYPE	NUM	DATE	PAYEE	DETAILS	AMT PAID	TOTALS
EFT Pymt	EFT 9891	24-Nov-2023	Dawsons Concrete and Reinforcing	23/24 Footpath Renewal (FC2401): Vincent St	(39,982.00)	
EFT Pymt	EFT 9892	24-Nov-2023	Department of Planning Lands and Heri	Nov 2023: 23/24 Leases M252204 & M355805	(389.57)	
EFT Pymt	EFT 9893	24-Nov-2023	Earthstyle Contracting Pty Ltd	RRG2403 Mawson Rd: Widen and seal	(361,926.40)	
EFT Pymt	EFT 9894	24-Nov-2023	Elders Rural Services Aust Ltd	RR085 Rickeys Rd: Fencing supplies	(160.75)	
EFT Pymt	EFT 9895	24-Nov-2023	Focus Audiovisual Pty Ltd	Programing of automated fire risk rating digital display	(2,138.40)	
EFT Pymt	EFT 9896	24-Nov-2023	Focus Networks	2023-11 Nov Computer Support incl UPS hardware	(6,572.21)	
EFT Pymt	EFT 9897	24-Nov-2023	Fulton Hogan Industries Pty Ltd	Various Rural Roads: 1T Ezstreet bulk bag	(704.00)	
EFT Pymt	EFT 9898	24-Nov-2023	Herseys Safety Pty Ltd	Various supplies	(718.91)	
EFT Pymt	EFT 9899	24-Nov-2023	Kleen West Distributors	Various bldgs: Cleaning products	(1,539.97)	
EFT Pymt	EFT 9900	24-Nov-2023	MBE Parramatta - Australian Credit Sta	Debtors: Reminder stickers for overdue accounts	(113.90)	
EFT Pymt	EFT 9901	24-Nov-2023	McIntosh and Son WA	BE030 (PBH02): Parts	(1,411.77)	
EFT Pymt	EFT 9902	24-Nov-2023	Node One Pty Ltd	2023-12 Dec NBN Fixed wireless Business FW Plus 75/10 mbps unlimited (5 shares)	(89.00)	
EFT Pymt	EFT 9903	24-Nov-2023	Northam Autos Pty Ltd ta Northam Hol	BEV0 (PSDN16): 40,000 km service	(779.71)	
EFT Pymt	EFT 9904	24-Nov-2023	Nutrien Water (nee Total Eden)	Rec Ground - Oval: Retic parts	(534.51)	
EFT Pymt	EFT 9905	24-Nov-2023	Officeworks Ltd	2023-11 Nov Stationery Order	(875.49)	
EFT Pymt	EFT 9906	24-Nov-2023	Perth Patio Magic P/L	Part pymts: LBS2404 - Admin Office Patio & LBS2405 – C/Park Picnic Shelter	(25,390.00)	
EFT Pymt	EFT 9907	24-Nov-2023	Samantha Jayne Mearns	Community Bus: Fuel reimbursement re excursion	(51.12)	
EFT Pymt	EFT 9908	24-Nov-2023	Services Australia (Child Support - D J	Payroll deductions	(1,023.40)	
EFT Pymt	EFT 9909	24-Nov-2023	St John Ambulance WA Ltd	Various bldgs & plant: Bi-Annual Servicing of first aid kits	(895.88)	
EFT Pymt	EFT 9910	24-Nov-2023	Staff - Daniel John Gibson	Reimbursement: Roofing tiles	(40.00)	
EFT Pymt	EFT 9911	24-Nov-2023	Staff - Stefan de Beer	Reimbursements: Oct - Nov 2023 Landline/Inet costs	(68.25)	
EFT Pymt	EFT 9912	24-Nov-2023	Synergy	2023-11 Nov Power accounts	(14,304.61)	
EFT Pymt	EFT 9913	24-Nov-2023	Team Global Express Pty Ltd (nee Toll	Freight charges: 25 Oct 2023	(35.86)	
EFT Pymt	EFT 9914	24-Nov-2023	Telstra Limited	2023-11 Nov Telephone accounts	(3,121.10)	
EFT Pymt	EFT 9915	24-Nov-2023	Vanguard Press	Area Promotion: Welcome to Beverley map pads	(467.50)	
EFT Pymt	EFT 9916	24-Nov-2023	WA Contract Ranger Services Pty Ltd	Ranger Services: 30 Oct - 10 Nov 2023	(1,306.25)	

SHIRE OF BEVERLEY

**CHEQUE DETAIL - Municipal and Trust Accounts - NOVEMBER 2023**

TYPE	NUM	DATE	PAYEE	DETAILS	AMT PAID	TOTALS
EFT Pymt	EFT 9917	24-Nov-2023	Workhouse Advertising Pty Ltd	Preparation of 2022/23 Annual Report	(1,980.00)	
EFT Pymt	EFT 9918	24-Nov-2023	York Laundromat	06 - 20 Nov 2023 Onsite Cabins Laundry fees	(486.09)	(493,758.69)
Direct Debit	DD 4387.01	07-Nov-2023	Shadforth Portfolio Service - Super	Superannuation contributions	(1,102.89)	
Direct Debit	DD 4387.02	07-Nov-2023	National Mutual Retirement Fund	Superannuation contributions	(264.15)	
Direct Debit	DD 4387.03	07-Nov-2023	Cbus Super Fund	Superannuation contributions	(272.91)	
Direct Debit	DD 4387.04	07-Nov-2023	Mercer Super Trust, The Trustee for	Superannuation contributions	(576.15)	
Direct Debit	DD 4387.05	07-Nov-2023	Australian Super	Superannuation contributions	(1,605.81)	
Direct Debit	DD 4387.06	07-Nov-2023	Aware Super Pty Ltd	Superannuation contributions	(7,176.20)	
Direct Debit	DD 4387.07	07-Nov-2023	Australian Retirement Trust (Super func	Superannuation contributions	(425.09)	
Direct Debit	DD 4387.08	07-Nov-2023	MLC MasterKey Personal Super	Superannuation contributions	(148.33)	
Direct Debit	DD 4387.09	07-Nov-2023	Colonial First State Super (Gibson Dani	Superannuation contributions	(317.51)	
Direct Debit	DD 4387.10	07-Nov-2023	AMP Lifetime Super	Superannuation contributions	(213.73)	
Direct Debit	DD 4387.11	07-Nov-2023	UniSuper	Superannuation contributions	(257.66)	
Direct Debit	DD 4387.12	07-Nov-2023	Prime Super P/L	Superannuation contributions	(275.96)	(12,636.39)
Direct Debit	DD 4400.01	21-Nov-2023	Shadforth Portfolio Service - Super	Superannuation contributions	(1,102.89)	
Direct Debit	DD 4400.02	21-Nov-2023	National Mutual Retirement Fund	Superannuation contributions	(171.34)	
Direct Debit	DD 4400.03	21-Nov-2023	Cbus Super Fund	Superannuation contributions	(272.91)	
Direct Debit	DD 4400.04	21-Nov-2023	Mercer Super Trust, The Trustee for	Superannuation contributions	(576.15)	
Direct Debit	DD 4400.05	21-Nov-2023	Australian Super	Superannuation contributions	(1,486.66)	
Direct Debit	DD 4400.06	21-Nov-2023	Aware Super Pty Ltd	Superannuation contributions	(7,006.00)	
Direct Debit	DD 4400.07	21-Nov-2023	Australian Retirement Trust (Super func	Superannuation contributions	(427.35)	
Direct Debit	DD 4400.08	21-Nov-2023	MLC MasterKey Personal Super	Superannuation contributions	(105.95)	
Direct Debit	DD 4400.09	21-Nov-2023	Colonial First State Super (Gibson Dani	Superannuation contributions	(317.51)	
Direct Debit	DD 4400.10	21-Nov-2023	AMP Lifetime Super	Superannuation contributions	(194.59)	
Direct Debit	DD 4400.11	21-Nov-2023	UniSuper	Superannuation contributions	(257.66)	
Direct Debit	DD 4400.12	21-Nov-2023	Prime Super P/L	Superannuation contributions	(275.96)	(12,194.97)

SHIRE OF BEVERLEY

**CHEQUE DETAIL - Municipal and Trust Accounts - NOVEMBER 2023**

TYPE	NUM	DATE	PAYEE	DETAILS	AMT PAID	TOTALS
Direct Debit	99	03-Nov-2023	7 - CBA Merchant Fee	CBA Merchant Fee - Muni	(331.94)	(331.94)
Direct Debit	99	03-Nov-2023	7 - CBA Merchant Fee	CBA Merchant Fee - Trust	(20.00)	(20.00)
Direct Debit	99	06-Nov-2023	8 - ANZ Transactive	ANZ Transactive	(77.00)	(77.00)
Direct Debit	99	06-Nov-2023	12 - ANZ - BPAY	ANZ - BPAY	(85.80)	(85.80)
Direct Debit	99	06-Nov-2023	12 - ANZ - BPAY	ANZ - BPAY	(77.00)	(77.00)
Direct Debit	99	08-Nov-2023	1 - Bank Charges	Bank Charges	120.00	120.00
Direct Debit	99	08-Nov-2023	1 - Bank Charges	Bank Charges - Reversal	(120.00)	(120.00)
Direct Debit	99	01-Nov-2023	3 - Payment for DoT	Payment for DoT	(7,129.70)	
Direct Debit	99	02-Nov-2023	3 - Payment for DoT	Payment for DoT	(3,219.20)	
Direct Debit	99	03-Nov-2023	3 - Payment for DoT	Payment for DoT	(198.25)	
Direct Debit	99	06-Nov-2023	3 - Payment for DoT	Payment for DoT	(996.20)	
Direct Debit	99	07-Nov-2023	3 - Payment for DoT	Payment for DoT	(3,494.85)	
Direct Debit	99	08-Nov-2023	3 - Payment for DoT	Payment for DoT	(3,594.55)	
Direct Debit	99	09-Nov-2023	3 - Payment for DoT	Payment for DoT	(593.25)	
Direct Debit	99	10-Nov-2023	3 - Payment for DoT	Payment for DoT	(1,397.20)	
Direct Debit	99	13-Nov-2023	3 - Payment for DoT	Payment for DoT	(3,189.30)	
Direct Debit	99	14-Nov-2023	3 - Payment for DoT	Payment for DoT	(2,022.50)	
Direct Debit	99	15-Nov-2023	3 - Payment for DoT	Payment for DoT	(1,465.15)	
Direct Debit	99	16-Nov-2023	3 - Payment for DoT	Payment for DoT	(296.80)	
Direct Debit	99	17-Nov-2023	3 - Payment for DoT	Payment for DoT	(1,031.90)	
Direct Debit	99	20-Nov-2023	3 - Payment for DoT	Payment for DoT	(1,587.80)	
Direct Debit	99	21-Nov-2023	3 - Payment for DoT	Payment for DoT	(3,271.85)	
Direct Debit	99	22-Nov-2023	3 - Payment for DoT	Payment for DoT	(3,126.60)	
Direct Debit	99	23-Nov-2023	3 - Payment for DoT	Payment for DoT	(3,910.20)	
Direct Debit	99	24-Nov-2023	3 - Payment for DoT	Payment for DoT	(1,707.70)	
Direct Debit	99	27-Nov-2023	3 - Payment for DoT	Payment for DoT	(996.85)	



SHIRE OF BEVERLEY

**CHEQUE DETAIL - Municipal and Trust Accounts - NOVEMBER 2023**

TYPE	NUM	DATE	PAYEE	DETAILS	AMT PAID	TOTALS
Direct Debit	99	28-Nov-2023	3 - Payment for DoT	Payment for DoT	(4,080.10)	
Direct Debit	99	29-Nov-2023	3 - Payment for DoT	Payment for DoT	(16,415.25)	
Direct Debit	99	30-Nov-2023	3 - Payment for DoT	Payment for DoT	(1,834.15)	(65,559.35)
Direct Debit	EFT 9881	23-Nov-2023	Credit Card - Shire of Beverley	2023-10 Oct Credit Card Purchases	(2,122.65)	(2,122.65)
<b>PAYMENTS RAISED IN CURRENT MONTH</b>					<b>(729,079.77)</b>	<b>(729,079.77)</b>
<b>WAGES &amp; SALARIES</b>						
EFT Pymt		08-Nov-2023	Wages & Salaries	FE - 07 November 2023	(66,222.73)	
EFT Pymt		22-Nov-2023	Wages & Salaries	FE - 21 November 2023	(62,743.02)	
<b>WAGES &amp; SALARIES</b>					<b>(128,965.75)</b>	<b>(128,965.75)</b>
<b>UNPRESENTED PAYMENTS for CURRENT BANK STATEMENT</b>						
<b>UNPRESENTED PAYMENTS for CURRENT BANK STATEMENT</b>					<b>0.00</b>	<b>0.00</b>
<b>PAYMENTS PRESENTED IN CURRENT BANK # RELATING to PRIOR MONTHS' TRANSACTIONS</b>						
<b>PAYMENTS PRESENTED IN CURRENT BANK # RELATING to PRIOR MONTHS' TRANSACTIONS</b>					<b>0.00</b>	<b>0.00</b>
<b>OTHER AMENDMENTS/GENERAL JOURNALS</b>						
<b>OTHER AMENDMENTS/GENERAL JOURNALS</b>					<b>0.00</b>	<b>0.00</b>
<b>INVESTMENTS</b>						
<b>INVESTMENTS</b>					<b>0.00</b>	
<b>TOTAL EXPENDITURE for MUNICIPAL ACCOUNT</b>						<b>(858,045.52)</b>

**CREDIT CARD PAYMENT SUMMARY for CURRENT BANK STATEMENT**

CEO - STEPHEN GOLLAN

SHIRE OF BEVERLEY

**CHEQUE DETAIL - Municipal and Trust Accounts - NOVEMBER 2023**

TYPE	NUM	DATE	PAYEE	DETAILS	AMT PAID	TOTALS
						<b>0.00</b>
<b>DCEO - SIMON MARSHALL (AVONDALE MACHINERY SHED)</b>						
Credit card	161971	06-Oct-2023	Planning Institute Aust	Awards for Planning Excellence, 17 Nov 2023 - 3 x attendees	825.00	
Credit card	1399856.1	14-Oct-2023	Parmelia Hilton Perth	Ready Tech Conference, 13 Oct 2023 DCEO S Marshall: Accommodation etc	364.65	
Credit card	1399856.2	14-Oct-2023	Parmelia Hilton Perth	Ready Tech Conference, 13 Oct 2023 DCEO S Marshall: Accommodation etc	60.00	
Credit card	888607-2	09-Nov-2023	Crown Towers	LG Prof Aust WA conference 8-10 Nov 2023: DCEO - Credit note overcharge	(9.00)	
Credit card	055860	25-Oct-2023	The Red Vault	Election Day 21 Oct 2023 - Refreshments x 3	59.00	<b>1,299.65</b>
<b>MOW - STEPHEN VINCENT</b>						
Credit card	6903-ULP	28-Sep-2023	Bev Dome Fuel	400 L ULP @ \$2.059/L inc	823.00	<b>823.00</b>
<b>September 2023 transactions presented on 25 October 2023 (EFT 9809), Shire of Beverley Municipal Bank account</b>						<b>2,122.65</b>

SHIRE OF BEVERLEY

**CHEQUE DETAIL - Municipal and Trust Accounts - NOVEMBER 2023**

TYPE	NUM	DATE	PAYEE	DETAILS	AMT PAID	TOTALS
<b><i>TRUST ACCOUNT DETAILS</i></b>						
<b><i>PAYMENTS RAISED IN CURRENT MONTH</i></b>						
Direct Debit	EFT 9836	14-Nov-2023	Barry Shardlow	Refund of 2023 LG Election nomination bond	(100.00)	
Direct Debit	EFT 9837	14-Nov-2023	Cr Christopher John Lawlor	Refund of 2023 LG Election nomination bond	(100.00)	
Direct Debit	EFT 9838	14-Nov-2023	Cr Darryl Brown	Refund of 2023 LG Election nomination bond	(100.00)	
Direct Debit	EFT 9839	14-Nov-2023	Cr Denise Jo Ridgway	Refund of 2023 LG Election nomination bond	(100.00)	(400.00)
<b><i>PAYMENTS RAISED IN CURRENT MONTH</i></b>					<b><i>(400.00)</i></b>	<b><i>(400.00)</i></b>
<b><i>PAYMENTS UNPRESENTED IN CURRENT BANK #</i></b>						
<b><i>PAYMENTS UNPRESENTED IN CURRENT BANK #</i></b>					<b><i>0.00</i></b>	<b><i>0.00</i></b>
<b><i>PAYMENTS PRESENTED IN CURRENT BANK # RELATING to PRIOR MONTHS' TRANSACTIONS</i></b>						
<b><i>PAYMENTS PRESENTED IN CURRENT BANK # RELATING to PRIOR MONTHS' TRANSACTIONS</i></b>					<b><i>0.00</i></b>	<b><i>0.00</i></b>
<b><i>OTHER AMENDMENTS / GENERAL JOURNALS</i></b>						
<b><i>OTHER AMENDMENTS / GENERAL JOURNALS</i></b>					<b><i>0.00</i></b>	<b><i>0.00</i></b>
<b><i>TOTAL EXPENDITURE for TRUST ACCOUNT</i></b>						<b><i>(400.00)</i></b>
<b>TOTAL EXPENDITURE as reconciled to the NOVEMBER 2023 BANK STATEMENTS</b>						
					Municipal Account Expenditure	<b>(858,045.52)</b>
					Trust Account Expenditure	<b>(400.00)</b>
<b>TOTAL EXPENDITURE for NOVEMBER 2023</b>						<b>(858,445.52)</b>

### **11.3 St John in the Wilderness Cemetery Record Digitisation (Unbudgeted Expense)**

---

<b>Submission To:</b>	<b>Ordinary Council Meeting 19 December 2023</b>
<b>Report Date:</b>	<b>8 December 2023</b>
<b>Applicant:</b>	<b>Administration</b>
<b>File Reference:</b>	<b>ADM 0148</b>
<b>Author and Position:</b>	<b>Simon Marshall, Deputy Chief Executive Officer</b>
<b>Previously Before Council:</b>	<b>No</b>
<b>Disclosure(s) Of Interest:</b>	<b>Nil</b>
<b>Attachments:</b>	<b>Confidential – Digitisation Proposal</b>

---

#### **SUMMARY**

Council to consider contracting Chronicle to undertake the digitisation of the St John in the Wilderness (Dale) cemetery records.

#### **BACKGROUND**

Council has previously undertaken digitisation of its Anglican, Uniting/Methodist and Catholic cemeteries.

The digitisation project has been very successful and consequently it is recommended that the digitisation of the St John in the Wilderness records be progressed. This would see all of Council's active cemeteries being managed on the same system and it would also allow an enhancement to the general public's ability to access cemetery records.

#### **COMMENT**

Chronicle have previously undertaken the digitisation works of Council's other cemeteries. The process has produced efficiencies from a customer service and operational perspective. Dealing with customers has become much more streamlined and reliable and the management of the cemeteries, including the digging of graves, has been significantly improved through utilising the system.

It is expected that undertaking the digitisation of St John in the Wilderness will add to these benefits. Proposed works will include an aerial survey and headstone survey in line with what has been done at the other locations.

There is currently no budget funding allowed to progress, however given the low cost, which includes the annual subscription fee, it is deemed to be a worthwhile investment.

#### **STATUTORY ENVIRONMENT**

The *Local Government Act 1995* allows the following in regards to unbudgeted expenditure:

6.8. Expenditure from municipal fund not included in annual budget

- (1) A local government is not to incur expenditure from its municipal fund for an additional purpose except where the expenditure —
  - (a) is incurred in a financial year before the adoption of the annual budget by the local government; or
  - (b) is authorised in advance by resolution\*; or

(c) is authorised in advance by the mayor or president in an emergency.

\* Absolute majority required.

(1a) In subsection (1) — additional purpose means a purpose for which no expenditure estimate is included in the local government's annual budget.

(2) Where expenditure has been incurred by a local government —

(a) pursuant to subsection (1)(a), it is to be included in the annual budget for that financial year; and

(b) pursuant to subsection (1)(c), it is to be reported to the next ordinary meeting of the council.

## CONSULTATION

Chronicle

## FINANCIAL IMPLICATIONS

\$4,854.00 unbudgeted.

## STRATEGIC IMPLICATIONS

Strategic Pillar: 4. Civic Leadership

Strategic Priorities: 4.2 Continuous organisational improvement

4.3 Responsible planning

## POLICY IMPLICATIONS

Nil

## RISK IMPLICATIONS

Medium (9) - There is a possible risk that utilising current records that an interment may occur in the wrong plot or that there is insufficient room for plots that are currently reserved. It is considered that the proposed works will mitigate these risks.

Consequence	Insignificant	Minor	Moderate	Major	Catastrophic
<b>Likelihood</b>					
Almost Certain	Medium (5)	High (10)	High (15)	Severe (20)	Severe (25)
Likely	Low (4)	Medium (8)	High (12)	High (16)	Severe (20)
Possible	Low (3)	Medium (6)	Medium (9)	High (12)	High (15)
Unlikely	Low (2)	Low (4)	Medium (6)	Medium (8)	High (10)
Rare	Low (1)	Low (2)	Low (3)	Low (4)	Medium (5)

Risk Rating	Action
Low	Monitor for ongoing improvement.
Medium	Comply with risk reduction measures to keep risk as low as reasonably practical.
High	Review the risk and take additional measures to ensure risk is low as reasonably achievable.
Severe	Unacceptable risk level, reduction measures must be introduced before proceeding.

## VOTING REQUIREMENTS

Absolute Majority

## OFFICER'S RECOMMENDATION

That unbudgeted expenditure of \$4,854.00 excluding GST for the digitisation of the St John in the Wilderness Cemetery records, as per Chronicle's proposal, be approved.

## **12. ADMINISTRATION**

### **12.1 Disability Access and Inclusion Plan 2023 – 2028**

---

<b>Submission To:</b>	<b>Ordinary Council Meeting 19 December 2023</b>
<b>Report Date:</b>	<b>13 December 2023</b>
<b>Applicant:</b>	<b>Administration</b>
<b>File Reference:</b>	<b>ADM 0048</b>
<b>Author and Position:</b>	<b>Alison Lewis, Executive Assistant</b>
<b>Previously Before Council:</b>	<b>28 November 2023</b>
<b>Disclosure(s) Of Interest:</b>	<b>None</b>
<b>Attachments:</b>	<b>Draft Disability Access and Inclusion Plan</b>

---

#### **SUMMARY**

Council to consider adopting the Draft Disability Access and Inclusion Plan.

#### **BACKGROUND**

In July 2013 Council adopted its first Disability Access and Inclusion Plan (2013-18). The *Disability Services Act 1993* requires that DAIP's are to be reviewed every 5 years. The current DAIP 2018-2023 will expire on 31 December 2023.

#### **COMMENT**

A desk top review of the 2018-2023 DAIP was completed in September 2023. The review included analysis of which tasks in the 2018-2023 DAIP were completed, incomplete, achieved and successful, or achieved but unsuccessful.

A Community Survey was then prepared based on the seven desired outcome areas of the Disability Services Act. The survey was available online or in hardcopy format from the Shire office. The survey ran from 22 September to 31 October 2023, with a total of 26 responses received. A physical town tour to review Shire assets was also completed. Many of the results and comments from the survey and town tour were used as a basis in the development the draft 2023-2028 DAIP.

At the 28 November 2023 Council reviewed the draft DAIP. It was then advertised in the Blarney, Bulletin, Facebook and Shire webpage. The draft was also sent to Department of Communities, participants of the workshops, town tour and surveys for final comment.

Proposed changes from the draft version as a result of final public comment:  
Addition in Outcome 2 - Consideration of a Changing Places location in any future new development.

Community Bus – change from not having wheelchair access to 'making an upgrade should funding for conversions become available'.

Linking to Other Plans – referencing the Shire's documentation.

#### **STATUTORY ENVIRONMENT**

The *Disability Services Act 1993* (amended 2004), requires that West Australian public authorities develop and implement a Disability Access and Inclusion Plan. The Act makes these plans mandatory and prescribes their development, implementation and reporting.

## CONSULTATION

Community  
Council  
Department of Communities

## FINANCIAL IMPLICATIONS

The DAIP identifies that any major tasks will need to be planned and costed through the Long Term Financial Plan and Annual Budgeting processes.

## STRATEGIC IMPLICATIONS

Strategic Pillar: 2. Community  
4. Civic Leadership  
Strategic Priorities: 2.3 Active and healthy community  
4.1 Community and customer focus  
4.2 Continuous organisational improvement  
4.3 Responsible planning

## POLICY IMPLICATIONS

N/A

## RISK IMPLICATIONS

Low (2) – the adoption of the DAIP will mitigate the risk of non-compliance. While the Shire and Council should ensure it meets the seven DAIP outcomes, there is generally no penalty if Councils own strategies/tasks cannot be met for acceptable reasons.

Consequence	Insignificant	Minor	Moderate	Major	Catastrophic
<b>Likelihood</b>					
Almost Certain	Medium (5)	High (10)	High (15)	Severe (20)	Severe (25)
Likely	Low (4)	Medium (8)	High (12)	High (16)	Severe (20)
Possible	Low (3)	Medium (6)	Medium (9)	High (12)	High (15)
Unlikely	Low (2)	Low (4)	Medium (6)	Medium (8)	High (10)
Rare	Low (1)	Low (2)	Low (3)	Low (4)	Medium (5)

Risk Rating	Action
Low	Monitor for ongoing improvement.
Medium	Comply with risk reduction measures to keep risk as low as reasonably practical.
High	Review the risk and take additional measures to ensure risk is low as reasonably achievable.
Severe	Unacceptable risk level, reduction measures must be introduced before proceeding.

## VOTING REQUIREMENTS

Simple Majority

## OFFICER'S RECOMMENDATION

That Council adopt the Disability Access and Inclusion Plan 2023-2028 and forward a copy to the Department of Communities.



# **Shire of Beverley Disability Access & Inclusion Plan 2023-2028**

Draft



## DISABILITY ACCESS & INCLUSION PLAN

### 2023-2028

<b>Document Status</b>	Draft
<b>Revision No.</b>	1
<b>Revision Date</b>	7 September 2023
<b>Prepared By</b>	Alison Lewis Executive Assistant
<b>Endorsed By</b>	Stephen Gollan Chief Executive Officer
<b>Adopted By Council</b>	
<b>Submitted to DoC</b>	29 November 2023 (Draft)
<b>Accepted by DoC</b>	

<b>Version</b>	<b>Issue Date</b>	<b>Author</b>	<b>Reason for Change</b>
1	7/09/2023	A Lewis	Draft for CEO
3	30/10/2023	A Lewis	Changes from Surveys and Town Tour.
4	8/11/2023	A Lewis	Changes from Workshop.
5	30/11/2023	A Lewis	Changes from DoC.
6			

# Contents

<b>Acknowledgments</b>	<b>4</b>
<b>Background</b>	<b>4</b>
• The Shire of Beverley	4
• Functions, facilities and services provided by the Shire of Beverley	5
• People with Disability in the Shire	6
• Legislation and Framework	6
<b>Access and inclusion policy statement</b>	<b>7</b>
<b>Development of the DAIP 2023 - 2028</b>	<b>8</b>
• Community consultation process	8
• Findings of the consultation and barriers	9
• Notable Achievements 2018 - 2023	10
• Barriers	12
<b>DAIP Strategies, Outcomes and Implementation</b>	<b>13</b>
• Responsibility for implementing the DAIP	22
• Relationship to other Documents	22
• Communicating the plan to staff and people with Disability	22
• Evaluation	22
• Reporting on the DAIP	22

## **Acknowledgements**

The Shire of Beverley acknowledge the Traditional Owners of the land, the Ballardong People, on which the Shire is situated. We recognise and respect their continuing culture and contribution they make to our community. We pay our respects to Elders past and present.

The Shire of Beverley acknowledges and appreciates the contribution received from community members, Shire staff and Shire Councillors which has been invaluable in the review process and preparation of this Disability Access Inclusion Plan.

## **Background**

### **The Shire of Beverley**

The Shire of Beverley is a stable and viable farming community located 130km to the east of Perth and covers an area of approximately 2,310 square kilometers.

For thousands of years the Ballardong Noongar have inhabited the region along the Avon (Colguler) River and Dale (Boyagurring Bilya) River and have a deep attachment to their country.

Beverley was one of the first areas in Western Australia opened for agriculture after a glowing report to Governor Stirling by Ensign Dale. Beverley was first settled in 1838 and was named after a town in Yorkshire, Northern England. The Beverley town site was established around 1868.

The Beverley Town site is located in a shallow basin with the Avon River running north-south and an intersected valley east-west. It is the rural service centre to the farming community which produces wheat and course grains as well as livestock.

Tourist Attractions include Wall Art Murials, Cornerstone Community Centre, Beverley Station Arts and Platform Theatre, Avondale Museum, Gliding, Dead Finish Museum, Various Art spaces, Yenyening Lakes and County Peak.

## **Functions, facilities and services provided by the Shire of Beverley**

The Shire of Beverley is responsible for a large range of functions, facilities and services including:

### **Services to property:**

- Construction and maintenance of roads and footpaths;
- Construction and maintenance of community buildings and facilities;
- Land drainage and development;
- Waste collection and disposal;
- Planting and caring for street trees;
- Numbering of buildings and lots; and
- Bush fire control and mitigation.

### **Services to the community:**

- Provision and maintenance of playing areas, parks, gardens, reserves;
- Community grants;
- Citizenship ceremonies;
- Facilities for sporting and community groups;
- Facilities and management of caravan park and cabins;
- Management of cemeteries;
- Management of pool, public library, community bus; and
- Advocates of health and aged care services.

### **Regulatory services:**

- Planning of road systems and town planning schemes;
- Building approvals for construction, additions or alterations to buildings; and
- Environmental health services and ranger services.

### **General administration:**

- The provision of general information to the public;
- The lodging of complaints and maintenance reports; and
- Payment of fees including rates, dog licences, cat licences and Department of Transport licensing.

### **Processes of government:**

- Providing Local Government to the Shire of Beverley;
- Ordinary and Special Council and committee meetings;
- Electors' meetings and election of Council Members;
- Public meetings, community consultation;
- Monthly update from the Shire President in the Beverley Blarney; and
- Integrated Planning – Long Term Financial Plan, Workforce Plan, Strategic Community Plan, Asset Management and Corporate Business Plans.

## **People with Disability in the Shire of Beverley**

There are 1,669 people living in the Shire of Beverley (2021 Census of Population and Housing). 190 require some form of assistance, 678 are living with a long-term health condition. 176 people provided unpaid assistance to a person with disability, health condition or aged person.

The Australian Bureau of Statistics (released in October 2019) Survey of Disability, Ageing and Carers (2018) identifies the following important statistics:

- In 2018 there were 4.4 million Australians with disability, 17.7% of the population
- 5.7% of all Australians had a profound or severe disability.
- Almost one-quarter (23.2%) of all people with disability reported a mental or behavioural disorder as their main condition.

## **Legislation and Framework**

With the largest age group in Beverley being 65 years and over and recognition that disability comes in many forms, the Shire of Beverley is committed to ensuring its DAIP strategies meet the required legislation and is considered in all strategic documents.

The Western Australia Disability Services Act (1993) requires all Local Governments to develop and implement a Disability Access and Inclusion Plan (DAIP) to ensure that people with disability have equal access to its facilities and services.

Other legislation underpinning access and inclusion includes the Western Australia State Equal Opportunity Act (1984) and the Commonwealth Disability Discrimination Act 1992 (DDA), both of which make discrimination on the basis of a person's disability unlawful.

The Council, management and staff promote a proactive approach to Disability Access and Inclusion into the culture and daily routine of the Shire of Beverley.

## Access and Inclusion Policy Statement

The Shire of Beverley is committed to ensuring that the community is accessible for and inclusive of people with disability, their families and carers.

The Shire of Beverley interprets an accessible and inclusive community as one in which all Council functions, facilities and services (in-house and contracted) are open, available and accessible to people with disability, providing all people with the same opportunities, rights and responsibilities as other people in the community.

### **The Shire of Beverley:**

- recognises that people with disability are valued members of the community who contribute to social, economic and cultural life;
- believes that a community that recognises its diversity and supports the participation and inclusion of all of its members makes for a richer community;
- believes that people with disability, their families and carers should be supported to be able to remain in the community of their choice;
- is committed to consulting with people with disability, their families and carers and disability organisations in addressing barriers to access and inclusion;
- will ensure its staff, agents and contractors work towards the desired seven outcomes in the DAIP; and

### **The Shire of Beverley is committed to achieving the seven outcomes of its Disability Access and Inclusion Plan, which are:**

1. People with disability have the same opportunities as other people to access the services of, and any events organised by, the Shire of Beverley.
2. People with disability have the same opportunities as other people to access the buildings and other facilities of the Shire of Beverley.
3. People with disability receive information from the Shire of Beverley in a format that will enable them to access the information as readily as other people are able to access it.
4. People with disability receive the same level and quality of service from the staff of the Shire of Beverley.
5. People with disability have the same opportunities as other people to make complaints to the Shire of Beverley.
6. People with disability have the same opportunities as other people to participate in any public consultation by the Shire of Beverley.
7. People with disability have the same opportunities as other people to obtain and maintain employment within the Shire of Beverley.



# Development of the 2023 – 2028 Disability Access and Inclusion Plan

## Community consultation process

In 2023, the Shire consulted with the Beverley Community to undertake a full and open review of the Council's Disability Access and Inclusion Plan (DAIP). This has included:

- Desktop review of the Disability Access and Inclusion Plan 2018 – 2023 including achievements and required improvements.
- Inviting the Community to participate in a DAIP survey.
- Beverley Blarney newspaper advertising, Beverley Bulletin advertising, Front Counter and Notice Board information at the Shire Office about the review and an invitation to comment or make a submission.
- Public Workshop with community members.
- Discussions with Councillors.
- A 'town tour' to physically assess connecting routes and facilities around town.
- Drafting a revised and updated DAIP which includes feedback and suggestions received throughout the consultation process.
- The draft plan was reviewed by Department of Communities.

## **Findings of the consultation**

The review and consultation found that many of the strategies and tasks within with 2018-23 DAIP had been achieved, however a small number were unsuccessful, ongoing or incomplete.

From the community survey, there was an overall satisfaction rate of over 89% in the six DAIP Outcome areas. However, Outcome 7 relating to employment, only scored a satisfaction rate of 75%.

The community workshops were very positive with a general feeling of appreciation for the Shire's continued upgrades to roads, footpaths and buildings. However, there was a general consensus that information could be received quicker and that the rocks in the main street deter ACROD parking users from parking in those bays.

Listed on the following pages are the achievements from the previous DAIP and the current identified barriers.

The new 2023-2028 plan will continue to strengthen the overall Shire and community culture and aim to address access barriers at the local level.

Draft

## Notable Achievements from DAIP 2018-23

Since the adoption of the DAIP 2018-23 the Shire has implemented initiatives and made progress towards better understanding, communication, consultation and access.

Outcome Area	Achievements
<p>1. People with disability have the same opportunities as other people to access the services of, and any events organised by, the Shire of Beverley.</p>	<ul style="list-style-type: none"> <li>▪ Spring Back to Beverley 150<sup>th</sup> Anniversary Event planned using Project Accessibility</li> <li>▪ Holds all public workshops in accessible venues.</li> </ul>
<p>2. People with disability have the same opportunities as other people to access the buildings and other facilities of the Shire of Beverley.</p>	<ul style="list-style-type: none"> <li>▪ Installation of electronic sliding doors at the Town Hall and Lesser Hall.</li> <li>▪ Construction of new accessible short stay cabin at the Caravan Park.</li> <li>▪ Construction of Moort Wabiny family park, includes wide paths, wide entrance.</li> <li>▪ Continuation of the 10 Year Footpath upgrade/repair or replacement program.</li> <li>▪ Completion of the Main Street redevelopment – wide and level footpaths, new ACROD bays, seating, improved lighting and kerbing.</li> <li>▪ Construction of ramp access to the Amenities Building at the Recreation Ground.</li> <li>▪ Safer crossing location for Hunt Road Village on Great Southern Highway (Hunt Rd)</li> </ul>
<p>3. People with disability receive information from the Shire of Beverley in a format that will enable them to access the information as readily as other people are able to access it.</p>	<ul style="list-style-type: none"> <li>▪ New Shire Facebook page to distribute information.</li> <li>▪ Shire SMS system for emergencies.</li> <li>▪ Beverley Blarney available electronically.</li> </ul>

<p>4. People with disability receive the same level and quality of service from the staff of the Shire of Beverley.</p>	<ul style="list-style-type: none"> <li>▪ 2019 and 2021 Councillor Elect packs distributed to potential Councillors to be aware of the Shire's DAIP and expectations.</li> <li>▪ New Staff receive DAIP as part of induction process.</li> </ul>
<p>5. People with disability have the same opportunities as other people to make complaints to the Shire of Beverley.</p>	<ul style="list-style-type: none"> <li>▪ The Shire continues a robust complaint register which is audited monthly to ensure any necessary action is taken and completed.</li> <li>▪ Added forms to website as an alternative method of contact.</li> </ul>
<p>6. People with disability have the same opportunities as other people to participate in any public consultation by the Shire of Beverley.</p>	<ul style="list-style-type: none"> <li>▪ Consultation held in safe accessible venues and presentations have paper and electronic copies made available.</li> <li>▪ The Shire will accept feedback from consultation in any format.</li> </ul>
<p>7. People with disability have the same opportunities as other people to obtain and maintain employment within the Shire of Beverley.</p>	<ul style="list-style-type: none"> <li>▪ The Shire continues to practice Equal Opportunity in its recruitment processes.</li> <li>▪ Shire staff are actively invited to give notice of their disability through surveys to ensure their workplace and equipment meets their needs annually.</li> </ul>

## Current Barriers

The barriers identified in the 2023 consultation process:

- A very small number of footpath upgrades and repairs are still required in areas around the town. Issues with the identified footpaths include uneven surfaces incorrect gradients.
- The Community Bus still does not have wheelchair access. Unfortunately due to costs, the new bus arriving in 2024 will not have wheelchair access. However, should new funding arise to make conversions, Council will consider the option.
- Access issues for people with disability at the Swimming Pool and function room toilets in the Amenities Building.
- Door entrance access issues for people with disability at the main entrance of the Amenities Building.
- Shire website no longer meeting standards.
- Event Planning form needs updating.
- Station Arts universal access toilet requires a ramp.
- Hooks are required in the Disabled Toilets for hanging bags.
- Large rocks next to ACROD Bays in the main street.
- Cemeteries do not have a dedicated ACROD Bay and uneven surfaces at the Niche Wall.
- Information dissemination needs to be more frequent.
- Wombat crossings – confusion in community as to who gives way.
- Yearly budget allocation or reserve for disability, access and inclusion improvements.

These findings will guide the development of strategies in this DAIP.

# Shire of Beverley

## Disability Access and Inclusion Plan

### **Strategies, Outcomes and Implementation Plan 2023 – 2028**

The following strategies have been developed to address each of the seven desired outcome areas of the Disability Services Act from feedback gained in the consultation process.

The Implementation Plan is the task, timelines and responsibilities for each strategy to be implemented throughout 2023-2028.

Draft



<b>Outcome 1: People with disability have the same opportunities as other people to access the services of, and any events organised, by the Shire of Beverley.</b>			
<b>Strategy</b>	<b>Task</b>	<b>Task Timeline</b>	<b>Responsibility</b>
Ensure that people with Disability are consulted on their need for services and the accessibility of current services.	<ul style="list-style-type: none"> <li>▪ Meet with people who have disability every two years as part of the DAIP reporting review.</li> <li>▪ Establish a yearly budget allocation or reserve to meet outcomes within the DAIP.</li> </ul>	Bi-Annually  24/25	Executive Staff
Monitor Shire services to ensure equitable access and inclusion.	<ul style="list-style-type: none"> <li>▪ Conduct internal reviews of the accessibility of services.</li> <li>▪ Inform Council of identified barriers and provide feedback to customers</li> </ul>	Annually	All Staff
Retain links between the DAIP and other Shire Integrated Plans.	<ul style="list-style-type: none"> <li>▪ Continue to incorporate the objectives and strategies of the DAIP into the Shire's integrated planning processes.</li> </ul>	Ongoing	CEO DCEO
Shire organised or funded events are accessible to people with Disability.	<ul style="list-style-type: none"> <li>▪ Ensure that all events are planned using the Shire event planning tool.</li> <li>▪ Regularly update the event planning tool.</li> </ul>	Ongoing	All Staff
Promote Disability Services and programs or events.	<ul style="list-style-type: none"> <li>▪ Identify any suitable programs or events to advertise and promote in the Beverley Blarney and Shire Website.</li> </ul>	Ongoing	PO TO EA

<b>Outcome 2: People with disability have the same opportunities as other people to access the buildings and other facilities of the Shire of Beverley.</b>			
<b>Strategy</b>	<b>Task</b>	<b>Task Timeline</b>	<b>Responsibility</b>
Ensure that all Shire buildings and facilities are physically accessible to people with Disability.	<ul style="list-style-type: none"> <li>▪ Council to cost and plan an approach to make at least one electronic door conversion at the Amenities Building.</li> </ul>	2024/25 Budget	CEO
	<ul style="list-style-type: none"> <li>▪ Ensure the proposed Swimming Pool Redevelopment includes safe access considerations.</li> </ul>	As it occurs	Project Committee
	<ul style="list-style-type: none"> <li>▪ Ensure any future Administration building development includes safe access considerations.</li> </ul>	As it occurs	
	<ul style="list-style-type: none"> <li>▪ Ensure the proposed Civic Centre Refurbishment includes safe access considerations.</li> </ul>	As it occurs	
	<ul style="list-style-type: none"> <li>▪ Ensure any Regional Precinct Planning considers safe access and inclusion.</li> </ul>	As it occurs	
	<ul style="list-style-type: none"> <li>▪ Install ramp to Beverley Station Arts Disabled Toilet.</li> </ul>	2023/24	
	<ul style="list-style-type: none"> <li>▪ Consideration is to be given to seek a suitable location and funding for Changing Places. This may include the Swimming Pool redevelopment, Avon Park redevelopment or other location.</li> </ul>	2024-2028	

<b>Outcome 2: People with disability have the same opportunities as other people to access the buildings and other facilities of the Shire of Beverley.</b>			
<b>Strategy</b>	<b>Task</b>	<b>Task Timeline</b>	<b>Responsibility</b>
Ensure that all new or redevelopment work to public buildings and applications incorporates universal access and meets BCA standards.	<ul style="list-style-type: none"> <li>▪ Ensure that the legal requirements for access are met in all plans for new or redeveloped buildings and facilities.</li> <li>▪ Ensure that development applications meet the legal requirements, and building or planning permits are not issued before doing so.</li> </ul>	2023-2028	MPDS  BS
Continuation of the 10 year footpath program.	<ul style="list-style-type: none"> <li>▪ Council to consider the extension of the footpath program until all identified paths are upgraded.</li> <li>▪ Repair gradient on the Dawson Street side of the Cornerstone Building.</li> <li>▪ Repair/replace uneven pavers at the Swimming Pool.</li> <li>▪ Repair/replace the footpath and car access to the Recreation Ground (Southern/Bowling Club side).</li> </ul>	2023-28	CEO DCEO SP  MOW
Advocate to local business the benefits flowing from the provision of accessible venues.	<ul style="list-style-type: none"> <li>▪ Increase awareness to local businesses on becoming more accessible and inclusive by providing results of DAIP surveys and workshops.</li> <li>▪ If funding becomes available for access and inclusion improvements, disseminate the information to local business.</li> </ul>	Ongoing	CEO EA PO TO

<b>Outcome 2: People with disability have the same opportunities as other people to access the buildings and other facilities of the Shire of Beverley.</b>			
<b>Strategy</b>	<b>Task</b>	<b>Task Timeline</b>	<b>Responsibility</b>
Ensure that all recreational areas are accessible.	<ul style="list-style-type: none"> <li>▪ Ensure any redevelopment in recreational areas includes universal access.</li> <li>▪ Redevelop the entrance to the Recreation Ground on the Southern Side.</li> <li>▪ Plan for future upgrade of the toilets located within the “old amenities” building.</li> </ul>	Ongoing	CEO BS
Ensure that ACROD parking meets the needs of people with Disability in terms of visibility quantity and location.	<ul style="list-style-type: none"> <li>▪ Evaluate ACROD bays and signs in the vicinity of Shire owned assets and buildings.</li> <li>▪ Remove large rocks that are situated near ACROD Bays on Vincent Street.</li> <li>▪ Install ACROD Bay at the Anglican Cemetery.</li> </ul>	Annually  23/24  2024	MOW

<b>Outcome 3: People with disability receive information from the Shire of Beverley in a format that will enable them to access the information as readily as other people are able to access it.</b>			
<b>Strategy</b>	<b>Task</b>	<b>Task Timeline</b>	<b>Responsibility</b>
Improve community awareness of Shire information being available in alternative formats.	<ul style="list-style-type: none"> <li>▪ Advertise that Shire documents and information is available in other formats in the Beverley Blarney.</li> <li>▪ Investigate a fortnightly newsletter via email in addition to the Blarney.</li> </ul>	Ongoing	EA

<b>Outcome 3: People with disability receive information from the Shire of Beverley in a format that will enable them to access the information as readily as other people are able to access it.</b>			
<b>Strategy</b>	<b>Task</b>	<b>Task Timeline</b>	<b>Responsibility</b>
Improve employee awareness of accessible information needs and how to provide information in other formats.	<ul style="list-style-type: none"> <li>▪ Ensure all new employees, councillors and contractors are aware of the DAIP in their respective induction process.</li> </ul>	Ongoing	HRO
Ensure that the Shire's website meets accessibility guidelines.	<ul style="list-style-type: none"> <li>▪ Upgrade the website to ensure it complies with the accessible web content guidelines and meets local needs.</li> <li>▪ Evaluate the website</li> </ul>	2024-25	DCEO

<b>Outcome 4: People with disability receive the same level and quality of service from the employees of the Shire of Beverley as other people receive.</b>			
<b>Strategy</b>	<b>Task</b>	<b>Task Timeline</b>	<b>Responsibility</b>
Ensure that all employees, current and new are aware of disability and access issues and have the skills to provide appropriate service and information.	<ul style="list-style-type: none"> <li>▪ Provide access and inclusion updates at staff meetings.</li> <li>▪ Assess Staff training needs in relation to DAIP knowledge at each performance review.</li> <li>▪ Provide all new employees a copy of the DAIP in the induction process.</li> </ul>	Ongoing	CEO DCEO HRO
Ensure that all Shire of Beverley's Policies and procedures relevant to Customer Service are consistent with the DAIP	<ul style="list-style-type: none"> <li>▪ Conduct an annual review of the Policy Manual and consider the DAIP when doing so.</li> </ul>	Annually	CEO

<b>Outcome 5: People with disability have the same opportunities as other people to make complaints to the Shire of Beverley.</b>			
<b>Strategy</b>	<b>Task</b>	<b>Task Timeline</b>	<b>Responsibility</b>
Ensure that feedback and grievance mechanisms are known and accessible for people with disability and are acted upon.	<ul style="list-style-type: none"> <li>▪ Continue with current grievance mechanisms by accepting complaints via phone, post, web-form, email, in-person and continue to audit and review monthly.</li> <li>▪ Promote alternative methods of communication including the National Relay Service and assistive technology apps.</li> </ul>	Ongoing	DCEO

<b>Outcome 6: People with disability have the same opportunities as other people to participate in any public consultation by a public authority.</b>			
<b>Strategy</b>	<b>Task</b>	<b>Task Timeline</b>	<b>Responsibility</b>
Ensure that people with disability are actively consulted about the DAIP.	<ul style="list-style-type: none"> <li>▪ Advertise the DAIP in all mediums (print, online, email)</li> <li>▪ Update the register of people to provide comment on access and inclusion issues.</li> </ul>	Ongoing	EA

<b>Outcome 6: People with disability have the same opportunities as other people to participate in any public consultation by a public authority.</b>			
<b>Strategy</b>	<b>Task</b>	<b>Task Timeline</b>	<b>Responsibility</b>
Ensure that all Shire public consultations, forums, workshops and meetings are inclusive and accessible and people with Disability are aware of them.	<ul style="list-style-type: none"> <li>▪ Ensure consultation can take form in different mediums, including in person, phone or electronically.</li> <li>▪ Ensure the consultation documentation is available in different formats.</li> <li>▪ Ensure feedback is able to be given in a range of formats.</li> <li>▪ Ensure consultation is held in an accessible location.</li> </ul>	Ongoing	All Staff

<b>Outcome 7: People with disability have the same opportunities as other people to obtain and maintain employment with the Shire of Beverley.</b>			
<b>Strategy</b>	<b>Task</b>	<b>Task Timeline</b>	<b>Responsibility</b>
Ensure that inclusive recruitment practices are applied when advertising all employment positions.	<ul style="list-style-type: none"> <li>▪ Review all draft advertisements and ensure the Equal Employment Opportunity statement is applied.</li> <li>▪ Advertise in different mediums.</li> <li>▪ Hold interviews in an accessible venue.</li> <li>▪ Promote equity and diversity in the work place and with volunteers.</li> </ul>	Ongoing	HRO CEO DCEO



<b>Outcome 7: People with disability have the same opportunities as other people to obtain and maintain employment with the Shire of Beverley.</b>			
<b>Strategy</b>	<b>Task</b>	<b>Task Timeline</b>	<b>Responsibility</b>
Improve methods of attracting, recruiting and retaining people with Disability.	<ul style="list-style-type: none"> <li>▪ Review the suitability of the Shire of Beverley as a workplace, including - workstations, plant and equipment, building access, parking and work hours.</li> <li>▪ Examine current methods of recruitment.</li> <li>▪ Ensure the relevant legislation is met when recruiting.</li> </ul>	Ongoing	HRO CEO DCEO

Draft

## **Responsibility for implementing the DAIP**

Implementation of the DAIP is the responsibility of every staff member and all operational areas of the Shire. The Disability Services Act (1993) requires all public authorities to take practical measures to ensure that the DAIP is implemented by its officers, employees, agents and contractors.

## **Relationships to other Shire Documents**

The Shire continually reviews other documents such as its Strategic Community Plan, Corporate Business Plan, Long Term Financial Plan, Policy Manual, Staff Surveys, Employment advertising and forms. When the reviews are held respectively, the strategies and tasks from the DAIP should be considered and then incorporated where possible so that each of the seven DAIP outcomes are met.

## **Communicating the plan to staff and people with Disability**

During review and following adoption, the Disability Access and Inclusion Plan will be sent to all those who contributed to the planning process.

## **Review and evaluation mechanisms**

The Disability Services Act requires that DAIPs be reviewed at least every five years. Whenever the DAIP is amended, a copy of the amended plan must be lodged with the Disability Services.

## **Evaluation**

- An evaluation will occur as part of the five-yearly review of the DAIP.
- The community, staff and Elected Members will be consulted as per the endorsed consultation strategies, as part of any evaluation.

## **Reporting on the DAIP**

The Disability Services Act requires the Shire to report on the progress of implementation of its DAIP in its annual report outlining:

- progress towards the desired outcomes of its DAIP;
- progress of its agents and contractors towards meeting the seven desired outcomes; and
- the strategies used to inform agents and contractors of its DAIP.

This plan is available online [www.beverley.wa.gov.au](http://www.beverley.wa.gov.au) or upon request in alternative formats.

## **12.2 Policy Manual – Annual Review**

<b>Submission To:</b>	<b>Ordinary Council Meeting 19 December 2023</b>
<b>Report Date:</b>	<b>13 December 2023</b>
<b>Applicant:</b>	<b>Administration</b>
<b>File Reference:</b>	<b>ADM 0468</b>
<b>Author and Position:</b>	<b>Stephen Gollan, Chief Executive Officer</b>
<b>Previously Before Council:</b>	<b>Occurs Annually – previous 25 October 2022</b>
<b>Disclosure(s) Of Interest:</b>	<b>Nil</b>
<b>Attachments:</b>	<b>Policy Manual</b>

Council to adopt any changes made through the annual review of the Shire of Beverley Policy Manual.

### **BACKGROUND**

Council are required to complete an annual review of the Policy Manual. The Policy Manual was last reviewed in October 2022.

### **COMMENT**

Shire Staff (and Councillors) were asked to review the current policies relevant to their work area, the following changes are requested and are in **red** on the page listed:

Policy Title	Page	Policy No.	Suggested Changes
Beverley Blarney	85	C016	<ul style="list-style-type: none"> <li>Remove reference to CRC (now L. Adams)</li> </ul>
Avondale Agricultural Museum Collection	88	C017	<ul style="list-style-type: none"> <li>Removal of MSC to use the museum for special events.</li> </ul>
Ordinary Meetings of Council	99	EM001	<ul style="list-style-type: none"> <li>Change Tuesday to Wednesday</li> </ul>
Council Agendas	101	EM 002	<ul style="list-style-type: none"> <li>Change agenda distribution dates</li> </ul>
Recording Voting of Motions	105	EM 006	<ul style="list-style-type: none"> <li>Updating to meet new legislation</li> </ul>
Standing Committees	107	EM 008	<ul style="list-style-type: none"> <li>Updated after most recent election</li> </ul>
Clearing Native Vegetation Along a Fence Line	New	W005	<ul style="list-style-type: none"> <li>Adopt</li> </ul>

One new policy W005, “Clearing Native Vegetation Along a Fence Line” is attached for consideration.

This policy has been developed in response to a request to clear land along a fence line. It was determined that the Shire has to grant permission to the landowner. The Department of Water and Environmental Regulation (DWER) has been consulted and research on other Shire’s policies was undertaken.

## STATUTORY ENVIRONMENT

*Local Government Act 1995* – Section 2.7 (2) (b) – The Council is to determine the Local Government’s policies.

## CONSULTATION

Staff  
Council

## FINANCIAL IMPLICATIONS

Nil

## STRATEGIC IMPLICATIONS

Strategic Pillar: 4. Civic Leadership  
Strategic Priorities: 4.2 Continuous organisational improvement  
4.3 Responsible planning

## RISK IMPLICATIONS

Shire of Beverley Council has a successful and effective history operation with its policies. Review of the Policy Manual reminds elected members and staff of Council Policies.

Consequence	Insignificant	Minor	Moderate	Major	Catastrophic
<b>Likelihood</b>					
Almost Certain	Medium (5)	High (10)	High (15)	Severe (20)	Severe (25)
Likely	Low (4)	Medium (8)	High (12)	High (16)	Severe (20)
Possible	Low (3)	Medium (6)	Medium (9)	High (12)	High (15)
Unlikely	Low (2)	Low (4)	Medium (6)	Medium (8)	High (10)
Rare	Low (1)	Low (2)	Low (3)	Low (4)	Medium (5)

Risk Rating	Action
Low	Monitor for ongoing improvement.
Medium	Comply with risk reduction measures to keep risk as low as reasonably practical.
High	Review the risk and take additional measures to ensure risk is low as reasonably achievable.
Severe	Unacceptable risk level, reduction measures must be introduced before proceeding.

## POLICY IMPLICATIONS

A001: Policy Manual

## VOTING REQUIREMENTS

Absolute Majority

## OFFICER’S RECOMMENDATION

That Council;

1. adopt policy W005 Clearing Native Vegetation Along a Fence Line; and
2. adopt any changes made in the annual review of the Policy Manual and incorporate them within the working document.

## 10.5 Clearing Native Vegetation Along a Fence Line

<b>Policy Type:</b>	Works	<b>Policy No:</b>	<b>W005</b>
<b>Date Adopted:</b>		<b>Date Last Reviewed:</b>	

<b>Legal (Parent):</b> 1. Environmental Protection Act 1986	<b>Legal (Subsidiary):</b> 1.
----------------------------------------------------------------	----------------------------------

ADOPTED POLICY	
<b>Title:</b>	<b>CLEARING NATIVE VEGETATION ALONG A FENCE LINE</b>
<b>Objective:</b>	<b>To provide a guideline for granting permission to clear along a fence line</b>

### Policy

The Manager of Works is able to grant permission (an exemption) on behalf of the Shire of Beverley to clear native vegetation between private property and Crown Land (e.g. a road reserve).

### Details

An exemption (*Regulation 5, Item 11 under the Environmental Protection Act 1986*) exists for clearing native vegetation between private property and Crown land (e.g. a road reserve), provided the following criteria are met;

1. The tree(s) is within crown land and along a fence-line; and
2. The purpose of clearing is to provide access to construct or maintain a fence between private property and crown land; and
3. The clearing is no more than 1.5m from the fence-line; and
4. The clearing does not exceed five hectares within that financial year; and
5. The clearing is not within an environmentally sensitive area.

**During the fence-line assessment, if the clearing does not meet the above criteria, the exemption does not apply and a clearing permit is required.**

### Notes:

- No native vegetation clearing is to be undertaken without written approval from the Shire (Manager of Works);
- A maximum of 1.5m width of native vegetation will be considered for approval for clearing along the fence line. The permitted clearing width may be less especially if vegetation at the location is already narrow;
- The clearing of significant trees may not get approval for clearing as they provide important habitat for species of high conservation protection;
- The application may take up to 4 weeks to be assessed;
- If the Manager of Works considers that the fence can be constructed and maintained without clearing, no permit will be issued.
- **It is the responsibility of the land owner and any other person carrying out the clearing on their behalf, to ensure compliance with the *Environmental Protection Act 1986 (EP Act)*, regardless of any advice given by the Shire.**

Although a tree may have limbs that overhang a fence and there is a possibility that a tree limb could fall and damage the fence at a later point in time, the tree cannot be cleared under this exemption unless all requirements are met. If the limbs do not impede access to the area to construct or maintain the fence (the second requirement) the exemption would not apply and a clearing permit issued by the Department of Water and Environmental Regulation (DWER) would be required. The limb itself could be removed (pruned) as it would not constitute 'clearing' as defined under the EP Act if the removal of this limb does not cause substantial damage to the tree and the trunk of the tree is not severed.

The exemption does not authorise the wholesale clearing of all native vegetation on the Crown land within 1.5 metres of the fence line, it only authorises the clearing of as much vegetation as is necessary "to provide access to construct or maintain a fence". Any clearing undertaken must be done in such a way to limit damage to neighbouring vegetation. Written approval from the Shire of Beverley must be obtained prior to undertaking the clearing.

To receive written approval, applicants must contact the Manager of Works in writing (email is acceptable) to apply for the exemption.

**Note:**

**Unauthorised Clearing of Native Vegetation:** The clearing of native vegetation in Western Australia without authorisation is an offence under the Environmental Protection Act 1986. Unlawful clearing by individuals can result in fines of up to \$250,000. Guidelines on clearing exemptions and applications for clearing permits are available on the DWER website [www.dwer.wa.gov.au](http://www.dwer.wa.gov.au)

# Policy Manual

## Shire of Beverley







# Table of Contents

<b>1. Accounting &amp; Finance</b> .....	<b>5</b>
1.1 Depreciation .....	5
1.2 Annual and Long Service Liability .....	6
1.3 Corporate Credit Card .....	7
1.4 Investing Surplus Funds.....	9
1.5 Bank Accounts and Payments .....	10
1.6 Rates Recovery.....	11
1.7 Purchasing and Procurement .....	13
1.8 Petty Cash.....	19
1.9 Rates – Special Payment Agreements .....	20
1.10 Asset Capitalisation.....	21
1.11 Related Party Disclosure.....	22
1.12 Rates – Rates Exemption (Non-Rateable Land) .....	23
1.13 Emergency Hardship Policy – Policy Suspended.....	27
1.14 Regional Price Preference .....	30
<b>2. Administration</b> .....	<b>32</b>
2.1 Policy Manual .....	32
2.2 Legal Advice.....	33
2.3 Risk Management .....	34
2.4 Public Interest Disclosure.....	35
2.5 Workforce Planning and Management Policy.....	45
2.6 Habitual or Vexatious Complaints .....	47
2.7 Asset Management .....	50
2.8 Closed Circuit Television (CCTV) Policy.....	51
2.9 Information and Communications Technology (ICT) Usage.....	59
<b>3. Community</b> .....	<b>64</b>
3.1 Community Use of Town Hall Meeting Room .....	64
3.2 Hiring of Furniture and Other Equipment .....	66
3.3 Deposits for Hiring Buildings .....	67
3.4 Liquor on Shire of Beverley Property.....	68
3.5 Public Buildings – Time Limits .....	69
3.6 Swimming Pool Season .....	70
3.7 Swimming Pool – Supervision.....	71
3.8 Community Bus .....	72
3.9 Flag Poles .....	73
3.10 Caravan Park – Maximum Stay .....	74
3.11 Caravan Park – Dogs.....	75
3.12 Community Grants .....	76
3.13 Community Use of the Digital Signage Trailers .....	79
3.14 Brand Usage ‘Beverley – Be very you’ .....	80
3.15 Cornerstone Digital Display.....	82

3.16	Beverley Blarney .....	85
3.17	Avondale Agricultural Museum Collection Policy.....	88
3.18	Request for Purchase and Placement of Memorial Seats .....	93
3.19	Child Safe Awareness Policy .....	96
<b>4.</b>	<b>Elected Members .....</b>	<b>99</b>
4.1	Ordinary Meetings of Council.....	99
4.2	Council Agendas .....	101
4.3	Media Statements and Public Relations .....	102
4.4	Conference and Meeting Expenses .....	103
4.5	Honour/Photo Board .....	104
4.6	Recording Voting of Motions.....	105
4.7	Elected Member Allowances.....	106
4.8	Standing Committees.....	107
4.9	Electoral Caretaker Period Policy .....	108
4.10	Councillor Training and Professional Development Policy .....	115
4.11	Attendance at Events .....	117
<b>5.</b>	<b>Fire Control .....</b>	<b>120</b>
5.1	Restricted and Prohibited Burning Period Dates .....	120
5.2	Burning Times .....	121
5.3	Roadside Verge Burning.....	122
5.4	Harvest and Vehicle Movement Bans.....	123
5.5	Annual Harvest Bans on Public Holidays.....	124
5.6	Harvesting Operations – Fire Fighting Equipment.....	125
5.7	Fire Fighting Attire.....	126
5.8	Motor Vehicles – Fire Extinguisher .....	127
5.9	Council Policy – Vehicles Attending Fires.....	128
5.10	Plant Usage Authority – Bush Fires .....	129
5.11	Approval of Fire Control Officers.....	130
5.12	Dual Registration of Fire Control Officers .....	131
5.13	Bush Fire Incident Reports.....	132
5.14	Fire Control Officer Annual and General Meetings.....	133
5.15	Emergency SMS Announcements .....	134
<b>6.</b>	<b>General .....</b>	<b>135</b>
6.1	Citizenship Ceremonies .....	135
<b>7.</b>	<b>Planning .....</b>	<b>136</b>
<b>8.</b>	<b>Record Keeping .....</b>	<b>137</b>
8.1	Records Management.....	137
<b>9.</b>	<b>Staff.....</b>	<b>138</b>
9.1	Equal Employment Opportunity .....	138
9.2	Industrial Representation .....	140
9.3	Senior Staff Designation & Appointment.....	141
9.4	Corporate Uniform, Dress Code and Hygiene at Work .....	142
9.5	Personal Protective Equipment .....	143

9.6	Gratuity Payments to Employees .....	144
9.7	Injury Management and Rehabilitation.....	145
9.8	Noise .....	146
9.9	Work Health & Safety.....	147
9.10	Discrimination, Harassment and Bullying Policy.....	149
9.11	Training and Development .....	152
9.12	Chief Executive Officer Annual Performance Review .....	154
9.13	Staff Annual Performance Review .....	155
9.14	Council Vehicles.....	156
9.15	Staff Housing Policy .....	157
9.16	No Smoking Policy .....	158
9.17	Organisational Chart .....	159
9.19	Staff Use of Shire Equipment.....	160
9.20	Master Keys .....	161
9.21	Grievance, Investigations and Resolutions Policy .....	162
9.22	Rostered Days Off.....	165
9.23	Service Pay Allowance.....	166
9.24	Grave Digging Allowance .....	167
9.25	Communications Policy .....	168
9.26	Leave for Defence Forces Active Reservists .....	171
9.27	Drug & Alcohol Policy.....	172
9.28	Social Media Policy .....	175
9.29	CEO Recruitment, Performance and Termination .....	178
9.30	Staff Emergency Leave - Policy Suspended.....	184
9.31	Appointment of an Acting Chief Executive Officer .....	185
9.32	Grader Loading .....	186
9.33	Higher Duties Policy.....	187
9.34	Staff Remuneration .....	188
<b>10.</b>	<b>Works.....</b>	<b>190</b>
10.1	Crossover Policy .....	190
10.2	Gravel Pit Rehabilitation.....	196
10.3	Gravel Royalties.....	197
10.4	Waste Facility Spill Policy .....	198

# 1. Accounting & Finance

## 1.1 Depreciation

<b>Policy Type:</b>	Accounting and Finance
<b>Date Adopted:</b>	September 2014

<b>Policy No:</b>	<b>AF001</b>
<b>Date Last Reviewed:</b>	25 October 2022

<b>Legal (Parent):</b>	1.
------------------------	----

<b>Legal (Subsidiary):</b>	1.
----------------------------	----

ADOPTED POLICY	
<b>Title:</b>	<b>Depreciation</b>
<b>Objective:</b>	<b>To establish the depreciation method and rates for the Shire of Beverley.</b>

### Policy

#### **Depreciation - Method**

All Property, Plant and Equipment to be depreciated using the straight line method.

From 1 July 1993, assets are to be depreciated from date of acquisition or, in the case of internally constructed assets, from the time the asset is completed and held ready for use.

#### **Depreciation – Rates**

All Property, Plant and Equipment, including freehold land, are depreciated as follows:

Land (freehold)	-	Nil
Buildings – Housing	-	25 years
Buildings – Public Buildings	-	50 years
Plant and Equipment	-	5 years
Light Plant	-	10 years
Heavy Plant	-	15 years
Furniture and Equipment	-	10 years
Office Equipment (Electronic)	-	5 years
Office Equipment (Computers)	-	3 years

## 1.2 Annual and Long Service Liability

<b>Policy Type:</b>	Accounting and Finance
<b>Date Adopted:</b>	September 2014

<b>Policy No:</b>	<b>AF002</b>
<b>Date Last Reviewed:</b>	25 October 2022

<b>Legal (Parent):</b>
1.

<b>Legal (Subsidiary):</b>
1.

ADOPTED POLICY	
<b>Title:</b>	<b>ANNUAL AND LONG SERVICE LIABILITY</b>
<b>Objective:</b>	<b>To establish annual and long service liabilities.</b>

### Policy

Each year, the accrued liability for annual leave and long service for that year is calculated on the presumption that all employees remain in service.

Employees are to accrue no more than 40 days annual leave.

Council may allocate funds to the Leave Reserve to cover the liability if leave is not taken within the current financial year.

Policy Amended: 25 October 2016

### 1.3 Corporate Credit Card

<b>Policy Type:</b>	Finance and Accounting
<b>Date Adopted:</b>	September 2014

<b>Policy No:</b>	<b>AF003</b>
<b>Date Last Reviewed:</b>	25 October 2022

<b>Legal (Parent):</b>
1.

<b>Legal (Subsidiary):</b>
1.

ADOPTED POLICY	
<b>Title:</b>	<b>CORPORATE CREDIT CARD</b>
<b>Objective:</b>	<b>To provide Council and Staff with consistent guidelines for the use of the Credit Card.</b>

#### Policy

##### **Use of the Corporate Credit Card**

The use of the Corporate Credit Card is only approved if there is a demonstrated need and advantage to the Shire. These include:

- Elimination or reducing time spent on paper based ordering and payments;
- Reduction of administrative costs;
- Reducing the number of payments per month;
- Provision of a useful resource in an emergency situation; and
- Reducing the need to carry cash on the premises.

##### **Applications for a Corporate Credit Card and Approval**

All applications for a Corporate Credit Card shall be approved by the Chief Executive Officer.

In the case of the Chief Executive Officer, the Council shall approve the application and determine the conditions for use and maximum credit limit and credit limit for each individual transaction.

##### **Register**

A register shall be maintained by the Deputy Chief Executive Officer of any Credit Cards issued. The register shall include:

- Date of approval by Chief Executive officer;
- Name of card holder;
- Conditions of use of the card; and
- A review date for continuing use of the card, not exceeding 24 months.

##### **Issuing of Corporate Credit Cards to Elected Members**

- (1) The Local Government Act does not make provision for the issuing of credit cards to Elected Members. (A Local Government can only pay allowances or reimburse expenses to an Elected Member).
- (2) Elected Members shall not be issued with a Corporate Credit Card as there are no provisions within the Act which allow an Elected Member to incur a debt.

### **Policies and Procedures Governing the Use of the Corporate Credit Card**

The following shall be controlling the use of the Corporate Credit Card:

#### **General:**

- An agreement is to be signed by the cardholder, which sets out the cardholder's responsibilities and legal obligations when using the Credit Card;
- A register by the Deputy Executive Officer of all current cardholders should be kept which includes card numbers, expiry date of the Credit Card, credit limit and details of goods and services the cardholder has authority to purchase;
- All new and existing cardholders shall be provided with a copy of the policies relating to the use of Credit Cards;
- When an employee misplaces their Credit Card, they shall promptly report the matter to the Deputy Chief Executive Officer who shall immediately cancel the card;
- When on extended periods of leave, the cardholder is to hand in their credit card to the Deputy Chief Executive Officer until their return;
- Credit Cards shall not be transferred to other users;
- Use of the reward schemes, such as Fly Buys, will not be permitted for personal gain;
- All surrendered Credit Cards shall be destroyed by the Deputy Chief Executive Officer in the presence of another employee;
- In the event that a cardholder fails to comply with the policy's requirements, the Chief Executive Officer shall withdraw the use of the Corporate Credit Card and take appropriate disciplinary action.
- All criminal/illegal acts of alleged misuse shall be reported to the Police and other relevant authorities; and
- The use of Corporate Credit Cards for personal entertainment uses is prohibited.

#### **Purchasing**

- Credit Cards shall only be used for purchasing goods and services on behalf of the Shire;
- Personal expenditure is strictly prohibited;
- A Credit Card shall not be used for cash withdrawals;
- Maximum credit limit shall be based on the cardholder's need and approved by the Chief Executive Officer and Council. The following will be used as a guide: -

Maximum credit limit and transaction limit per card will be as follows:

Name	\$ Credit Limit Per Month	\$ Maximum Credit Limit per Transaction
Chief Executive Officer	10,000.00	5,000.00
Manager of Works	5,000.00	5,000.00
Avondale Museum	500.00	500.00

- Purchases made by email, telephone or over the internet to be authorised by the Chief Executive Officer and all paperwork is to be kept and payments verified;

#### **Payments**

- The cardholder shall provide appropriate and sufficient documentary evidence of all charges, as required, on a regular basis;
- Time frames for all payment of accounts shall be monitored by the Deputy Chief Executive Officer to ensure that credit charges are minimised and accounts are paid so as not to incur a penalty or interest;
- Cardholders cannot approve expenditure incurred on their own cards – these will be referred to the Chief Executive Officer for approval – the Chief Executive Officer shall refer any such instances to the Deputy Chief Executive Officer.
- A separate itemised account will be presented to Council each month as part of the "Accounts Paid by Authority" Agenda item.

Policy Amended: 25 October 2016

Policy Amended: 26 September 2017

Policy Amended: 27 August 2019

Policy Amended: 25 August 2020

Policy Amended: 23 November 2021



## 1.4 Investing Surplus Funds

<b>Policy Type:</b>	Accounting and Finance
<b>Date Adopted:</b>	September 2014

<b>Policy No:</b>	<b>AF004</b>
<b>Date Last Reviewed:</b>	25 October 2022

<b>Legal (Parent):</b>
1. Financial Management Act 2006

<b>Legal (Subsidiary):</b>
1.

ADOPTED POLICY	
<b>Title:</b>	<b>INVESTING SURPLUS FUNDS</b>
<b>Objective:</b>	<b>To provide guidelines for investing surplus funds.</b>

### Policy

1. The Deputy Chief Executive Officer reviews the cash position of the Council. During the review the Deputy Chief Executive Officer considers such things as the balance of sundry creditors and debtors, supply orders outstanding, normal operating expenses such as payroll and loan repayments and any other abnormal payments.
2. Any cash held, in excess of current requirements, is transferred to interest bearing term deposits for an appropriate period of time. The maximum periods are set as follows:

Municipal Account	6 months
Reserve Account	1 year
3. The nature, location and transactions relating to each investment are documented in an investment register (Financial Management Regulation 19 (2)). Investments are reconciled and recorded in the general ledger each month and are reported to Council.

## 1.5 Bank Accounts and Payments

<b>Policy Type:</b>	Accounting and Finance
<b>Date Adopted:</b>	September 2014

<b>Policy No:</b>	<b>AF005</b>
<b>Date Last Reviewed:</b>	25 October 2022

<b>Legal (Parent):</b>
1. Local Government Act 1995

<b>Legal (Subsidiary):</b>
1. LG (Financial Management) Regulations 1996

ADOPTED POLICY	
<b>Title:</b>	<b>BANK ACCOUNTS AND PAYMENTS</b>
<b>Objective:</b>	<b>To provide a signing policy for all bank accounts.</b>

### Policy

1. That the Chief Executive Officer and the Deputy Chief Executive Officer are the authorised signatories to enable effective and efficient payment of accounts on behalf of the Shire of Beverley.
2. All payments including the Municipal Fund, the Trust Fund, Payroll and all Electronic Fund Transfers must have the signatures of **both** the Chief Executive Officer and the Deputy Chief Executive Officer.
3. Where either the Chief Executive Officer or the Deputy Chief Executive Officer are unavailable, the payment will be authorised by one Councillor and either the Chief Executive Officer or the Deputy Chief Executive Officer.
4. Where both the Chief Executive Officer and Deputy Chief Executive Officer are unavailable, the President and one Councillor may authorise payments.
5. Where the Chief Executive Officer or Deputy Chief Executive Officer are claimants for an expense reimbursement, they shall not authorise the payment. Such reimbursement payments shall be authorised as per point three (3) above.

Policy Amended: March 2015  
 Policy Amended: May 2015  
 Policy Amended: 27 August 2019

## 1.6 Rates Recovery

<b>Policy Type:</b>	Accounting and Finance
<b>Date Adopted:</b>	September 2014

<b>Policy No:</b>	<b>AF006</b>
<b>Date Last Reviewed:</b>	25 October 2022

<b>Legal (Parent):</b>
1.

<b>Legal (Subsidiary):</b>
1.

ADOPTED POLICY	
<b>Title:</b>	<b>RATES RECOVERY</b>
<b>Objective:</b>	<b>To collect all rates, annual charges and user charges due to Council in an efficient and effective manner. This policy is also to ensure that ratepayers who do not meet their obligations to Council will be treated in a fair and consistent manner by providing firm guidelines for the Rates Officer to follow.</b>

### Policy

Council authorises the Chief Executive Officer to make arrangements with ratepayers to clear debts and further Council authorises the Chief Executive Officer to take appropriate action to recover overdue Rates and Charges, ensuring the most cost effective method is used.

There will be no general distinction made for pensioners or any class of ratepayer, with each case being individually dealt with according to the circumstances. Council is aware that at different times ratepayers may experience genuine hardship in meeting rate payments and upon application suitable arrangements for the payment of rates will be considered.

The Shire of Beverley levies rates on an annual basis, with some exceptions. In accordance with legislation the ratepayer is given a minimum of 35 days, from the date of issue, to pay their rates. After this date, if an instalment option has not been chosen, rates are considered overdue and in arrears. Arrears are subject to a penalty interest, calculated daily.

- Where rates remain outstanding 14 days after the due date shown on the Rate Notice and the ratepayer has NOT elected to pay by the 4-instalment option, an Overdue Notice shall be issued requesting full payment within 7 days.
- Where rates still remain outstanding after the 7 days, a Final Notice shall be issued requesting immediate payment.
- Rates remaining unpaid after the expiry date on the Final Notice will be examined for the purpose of issuing a Notice of Intention to Summons.
- Where a payment still remains outstanding, despite the issue of a Notice of Summons, and the ratepayer has not entered into a payment arrangement a Claim (Summons) will be issued for recovery, provided the debt is greater than \$1,000.

- Where a Claim has been issued and remains unsatisfied, action will be taken to pursue that Claim by a Collection agency to secure payment of the debt.
- Following the issue of a Claim and addition of legal costs, a reasonable offer to discharge a rate account will not be refused.
- 'Payments by Special Arrangement' instalments will be calculated so that the minimum repayment will clear, or substantially reduce, the balance owing by the end of the current financial year, with a minimum repayment of \$50/week. A new arrangement must be entered into each financial year.
- Failure to adhere to a payment arrangement that has been put in place will result in legal action for recovery of unpaid rates and charges.
- Legal proceedings will continue until payment of rates imposed is secured. This includes the issue of a Property Seizure and Sale Order (PSSO) against goods and land if necessary.
- If a Property Seizure and Sale Order (PSSO) against land is proposed, to collect outstanding rates due, on a property where the **owner resides**, approval of Council shall be obtained before the PSSO is lodged.
- PSSO's against land will be used to collect outstanding amounts in respect to investment properties without a requirement that these be referred to Council.
- In cases where the owner of a leased or rented property, on which rates are outstanding, cannot be located, or refuses to settle rates owed, notice will be served on the lessee or tenant under the provisions of section 6.60 of the Local Government Act 1995, requiring the lessee or tenant to pay to Council the rent due under the lease/tenancy agreement as it becomes due, until the amount in arrears has been fully paid.
- Where the owner is registered for a pensioner rebate on rates and ESL (where the deferment option may be available) or where the owner is registered for a seniors rebate (25% & no deferment option); debt recovery may proceed for the collection of unpaid charges which are not subject to a rebate or deferment (eg: rubbish collection charges).
- Where a Rates and Charges debt remains outstanding for 3 years and legal proceedings have not been successful, Council will, under section 6.64 of the *Local Government Act 1995*:
  - Take possession of the land;
  - Lease the Land;
  - Transfer the land to the Crown; or
  - Sell the land.

Policy Amended: 23 November 2021

## 1.7 Purchasing and Procurement

<b>Policy Type:</b>	Accounting and Finance
<b>Date Adopted:</b>	September 2014

<b>Policy No:</b>	<b>AF007</b>
<b>Date Last Reviewed:</b>	25 October 2022

<b>Legal (Parent):</b>
1. Local Government Act 1995

<b>Legal (Subsidiary):</b>
1. Local Government Regulations 1996

ADOPTED POLICY	
<b>Title:</b>	<b>PURCHASING AND PROCUREMENT</b>
<b>Objective:</b>	<b>To ensure consistency for all purchasing activities that occur within all the Shire of Beverley operational areas and to provide compliance with the Local Government Act 1995 and the Local Government (Functions and General) Regulations 1996.</b>

### Policy

#### **INTENT**

The intent of this policy is to provide clear direction to staff when carrying out purchasing of goods and services for the Shire of Beverley and to ensure that purchasing is undertaken in an efficient, effective, economical and sustainable manner that provides transparency and accountability of the procurement process. This policy:

- Provides the Shire of Beverley with an effective way of purchasing goods and services.
- Ensures that purchasing transactions are carried out in a fair and equitable manner.
- Strengthens integrity and confidence in the purchasing system.
- Ensures that the Shire of Beverley receives value for money in its purchasing.
- Provides for the Shire of Beverley to consider the environmental impact of the procurement process across the life cycle of goods and services.
- Ensures the Shire of Beverley is compliant with all regulatory obligations.
- Promotes effective governance and definition of roles and responsibilities.
- Apply purchasing practices that withstands probity.

#### **ETHICS AND INTEGRITY**

All officers and employees of the Shire of Beverley shall observe the highest standards of ethics and integrity in undertaking purchasing activity and act in an honest and professional manner that supports the good standing of the Shire of Beverley.

The following principles, standards and behaviours must be observed and enforced through all stages of the purchasing process to ensure the fair and equitable treatment of all parties;

- Full accountability shall be taken for all purchasing decisions and the efficient, effective and proper expenditure of public monies based on achieving value for money;
- All purchasing practices shall comply with relevant legislation, regulations, and requirements consistent with the Shire of Beverley policies and code of conduct;
- Purchasing is to be undertaken on a competitive basis in which all potential suppliers are treated impartially, honestly and consistently;

- All processes, evaluations and decisions shall be transparent, free from bias and documented in accordance with applicable policies and audit requirements;
- Any actual or perceived conflicts of interest are to be identified, disclosed and appropriately managed; and
- Any information provided to the Shire of Beverley by a supplier shall be treated as commercial-in-confidence and should not be released unless authorised by the supplier or relevant legislation.

### VALUE FOR MONEY

Value for money is an overarching principle governing purchasing that allows the best possible outcome to be achieved for the Shire of Beverley. It is important to note that compliance with the specification is more important than obtaining the lowest price, particularly taking into account user requirements, quality standards, sustainability, life cycle costing, and service benchmarks

An assessment of the best value for money outcome for any purchasing should consider:

- All relevant whole-of-life costs and benefits whole of life cycle costs (for goods) and whole of contract life costs (for services) including transaction costs associated with acquisition, delivery, distribution, as well as other costs such as but not limited to holding costs, consumables, deployment, maintenance and disposal.
- The technical merits of the goods or services being offered in terms of compliance with specifications, contractual terms and conditions and any relevant methods of assuring quality;
- Financial viability and capacity to supply without risk of default. (Competency of the prospective suppliers in terms of managerial and technical capabilities and compliance history); and
- Competition in the allocation of orders or the awarding of contracts. This is achieved by obtaining a sufficient number of competitive quotations wherever practicable.

Where a higher priced conforming offer is recommended, there should be demonstrable benefits over and above the lowest total priced, conforming offer.

### SUSTAINABLE PROCUREMENT

Sustainable Procurement is defined as the procurement of goods and services that have less environmental and social impacts than competing products and services.

The Shire of Beverley is committed to sustainable procurement and where appropriate shall endeavour to design quotations and tenders to provide an advantage to goods, services and/or processes that minimise environmental and negative social impacts. Sustainable considerations must be balanced against value for money outcomes in accordance with any Shire of Beverley sustainability objectives.

### PURCHASING THRESHOLD

Where the value of procurement (excluding GST) for the value of the contract over the full contract period (including options to extend) is, or is expected to be:

Amount of Purchase	Requirements
Up to \$5,000	Direct purchase from supplier at purchaser(s) discretion.
\$5,001 - \$29,999	One written quote.
\$30,000 - \$49,999	Obtain at least two written quotations.
\$50,000 - \$249,999	Obtain at least three written quotations containing price and specification of goods and services (with procurement decision based on all value for money considerations).
\$250,000 and above	Conduct a public tender process.

Where it is considered beneficial, tenders may be called in lieu of seeking quotations for purchases under the \$250,000 threshold (excluding GST). If a decision is made to seek public tenders for Contracts of less than \$250,000, a Request for Tender process that entails all the procedures for tendering outlined in this policy must be followed in full.

The Chief Executive Officer may, where it is not possible to obtain the minimum quotations or in any other justifiable circumstances, waive the need to seek the required number of quotations prior to undertaking a purchase.

All parties providing quotations are to be notified if they are unsuccessful (note successful parties will be notified formally by issue of a purchase order).

The Shire of Beverley will compile and maintain a preferred list of suppliers if the Chief Executive Officer believes it is warranted. Only one quote, unless considered prudent to seek more, is required for prospective purchases made from a supplier listed on the Shire's preferred list of suppliers.

**Up to \$5,000**

Where the value of procurement of goods or services does not exceed \$5,000, direct purchase from the supplier may be made. However, it is recommended to use discretion and occasionally undertake market testing with a greater number or more formal forms of quotation to ensure best value is maintained.

This purchasing method is suitable where the purchase is relatively small and low risk.

Record keeping requirements must be maintained in accordance with record keeping policies.

**\$5,001 to \$29,999**

This category is for the procurement of goods or services where the value of such procurement ranges between \$5,001 and \$29,999.

A (one) written quotation is required.

The general principles for obtaining written quotations are:

- Ensure that the requirement/specification is clearly understood by the Shire of Beverley employee seeking the quotations;
- Ensure that the requirement is clearly, accurately and consistently communicated to each of the suppliers being invited to quote;

Record keeping requirements must be maintained in accordance with record keeping policies.

**\$30,000 to \$49,999**

For the procurement of goods or services where the value exceeds \$30,000 but is less than or equal to \$49,999, it is required to obtain at least two written quotes (commonly a sufficient number of quotes would be sought according to the type and nature of purchase).

The responsible officer is expected to demonstrate due diligence seeking quotes and to comply with any record keeping and audit requirements.

Record keeping requirements must be maintained in accordance with record keeping policies.

NOTES: The general principles relating to written quotations are:

- An appropriately detailed specification should communicate requirement(s) in a clear, concise and logical fashion.
- Invitations to quote should be issued simultaneously to ensure that all parties receive an equal opportunity to respond.
- Offer to all prospective suppliers at the same time any new information that is likely to change the requirements.
- Responses should be assessed for compliance, then value for money and all evaluations documented.
- Respondents should be advised as soon as possible after the final determination is made and approved.

**\$50,000 to \$249,999**

For the procurement of goods or services where the value exceeds \$50,000 but is less than or equal to \$249,999, it is required to obtain at least three written quotations containing price and a sufficient amount of information relating to the specification of goods and services being purchased.

For this procurement range, the selection should not be based on price alone, and it is recommended to consider some of the qualitative factors such as quality, stock availability, accreditation, time for completion or delivery,

warranty conditions, technology, maintenance requirements, organisation's capability, previous relevant experience and any other relevant factors as part of the assessment of the quote.

## **REGULATORY COMPLIANCE**

### **Tender Exemption**

In the following instances public tenders or quotation procedures are not required (regardless of the value of expenditure):

- An emergency situation as defined by the Local Government Act 1995;
- The purchase is under a contract of WALGA (Preferred Supplier Arrangements), Department of Treasury and Finance (permitted Common Use Arrangements), Regional Council, or another Local Government;
- The purchase is under auction which has been authorised by Council;
- The contract is for petrol, oil, or other liquid or gas used for internal combustion engines; or
- Any of the other exclusions under Regulation 11 of the Functions and General Regulations apply.

### **Sole Source of Supply (Monopoly Suppliers)**

The procurement of goods and/or services available from only one private sector source of supply (i.e. manufacturer, supplier or agency) is permitted without the need to call competitive quotations provided that there must genuinely be only one source of supply. Every endeavour to find alternative sources must be made. Written confirmation of this must be kept on file for later audit.

**Note:** The application of provision "sole source of supply" should only occur in limited cases and procurement experience indicates that generally more than one supplier is able to provide the requirements.

### **Anti-Avoidance**

The Shire of Beverley shall not enter two or more contracts of a similar nature for the purpose of splitting the value of the contracts to take the value of consideration below the level of \$250,000, thereby avoiding the need to publicly tender.

### **Tender Criteria**

The Shire of Beverley shall, before tenders are publicly invited, determine in writing the criteria for deciding which tender should be accepted.

An evaluation panel shall be established prior to the advertising of a tender and include a mix of skills and experience relevant to the nature of the purchase.

### **Advertising Tenders**

Tenders are to be advertised in a state-wide publication e.g. "The West Australian" newspaper, Local Government Tenders section, preferably on a Wednesday or Saturday.

The tender must remain open for at least 14 days after the date the tender is advertised.

The notice must include:

- a brief description of the goods or services required;
- information as to where and how tenders may be submitted;
- the date and time after which tenders cannot be submitted;
- particulars identifying a person from who more detailed information as to tendering may be obtained;



detailed information shall include:

- detailed specifications of the goods or services required;
- the criteria for deciding which (if any) tender should be accepted; and
- how tenders are to be submitted: by hand, post or other electronic means

### **Issuing Tender Documentation**

Tenders will not be made available (counter, mail, internet, referral, or other means) without a robust process to ensure the recording of details of all parties who acquire the documentation.

This is essential as if clarifications, addendums or further communication is required prior to the close of tenders, all potential tenderers must have equal access to this information.

### **Tender Deadline**

A tender that is not received in full in the required format by the advertised Tender Deadline shall be rejected.

### **Opening of Tenders**

No tenders are to be removed from the tender box, or opened (read or evaluated) prior to the Tender Deadline.

Tenders are to be opened in the presence of the Chief Executive Officer's delegated nominee and preferably at least one other Council Officer. The details of all tenders received and opened shall be recorded in the Tenders Register.

Tenders are to be opened in accordance with the advertised time and place. There is no obligation to disclose or record tendered prices at the tender opening, and price information should be regarded as *commercial-in-confidence* to the Local Government. Members of the public are entitled to be present.

At least two Shire of Beverley Officers will be present at the opening of tenders. WALGA E-Quotes are an exception and can be opened by one officer.

### **No Tenders Received**

Where the Shire of Beverley has invited tenders, however no compliant submissions have been received, direct purchases can be arranged on the basis of the following:

- a sufficient number of quotations are obtained;
- the process follows the guidelines for seeking quotations between \$40,000 and \$149,999 (listed above);
- the specification for goods and/or services remains unchanged; and
- purchasing is arranged within 6 months of the closing date of the lapsed tender.

### **Tender Evaluation**

Tenders that have not been rejected shall be assessed by the Shire of Beverley by means of a written evaluation against the pre-determined criteria. The tender evaluation panel shall assess each tender that has not been rejected to determine which tender is most advantageous.

### **Addendum to Tender**

If, after the tender has been publicly advertised, any changes, variations or adjustments to the tender document and/or the conditions of tender are required, the Shire of Beverley may vary the initial information by taking reasonable steps to give each person who has sought copies of the tender documents notice of the variation.

### **Minor Variation**

If after the tender has been publicly advertised and a successful tenderer has been chosen but before the Shire of Beverley and tenderer have entered into a Contract, a minor variation may be made by the Shire of Beverley.

A minor variation will not alter the nature of the goods and/or services procured, nor will it materially alter the specification or structure provided for by the initial tender.

### **Notification of Outcome**

Each tenderer shall be notified of the outcome of the tender following Council resolution. Notification shall include:

- The name of the successful tenderer.
- The total value of consideration of the winning offer.

The details and total value of consideration for the winning offer must also be entered into the Tenders Register at the conclusion of the tender process.

**Records Management**

All records associated with the tender process or a direct purchase process must be recorded and retained. For a tender process this includes:

- Tender documentation;
- Internal documentation;
- Evaluation documentation;
- Enquiry and response documentation;
- Notification and award documentation.

For a direct purchasing process this includes:

- Quotation documentation;
- Internal documentation;
- Order forms and requisitions.

Record retention shall be in accordance with the minimum requirements of the State Records Act, and the Shire of Beverley internal records management policy.

**OFFICERS AUTHORITY TO PURCHASE**

1. No person shall acquire any goods and/or services without first having issued an order form to the relevant provider.

(In the case where multiple purchases are made from local businesses, order forms shall be given to the supplier at least every month.)

2. Only those persons authorised to sign purchase orders shall be permitted to acquire goods and/or services.
3. The following persons are authorised to sign purchases orders:

<b>CEO .....</b>	<b>GENERAL AUTHORITY</b>
<b>DEPUTY CEO .....</b>	<b>GENERAL AUTHORITY</b>
<b>WORKS SUPERVISOR .....</b>	<b>\$100,000 MAX *</b>
<b>BUILDING SURVEYOR .....</b>	<b>\$...3,000 MAX *</b>
<b>BUILDING MAINTENANCE OFFICER.....</b>	<b>\$...3,000 MAX *</b>
<b>COMMUNITY EMERGENCY SERVICES MANAGER.....</b>	<b>\$...3,000 MAX</b>
<b>TOWN PLANNER .....</b>	<b>\$...3,000 MAX</b>
<b>LEADING HAND.....</b>	<b>\$...2,000 MAX</b>
<b>MOTOR MECHANIC.....</b>	<b>\$...2,000 MAX</b>
<b>LEADING HAND GARDNER.....</b>	<b>\$...2,000 MAX</b>
<b>ENVIRONMENTAL HEALTH OFFICER.....</b>	<b>\$...1,500 MAX</b>

\* EXEMPTION is granted for purchase of fuel stocks.  
All acquisitions should be in accordance with budget provisions or to a maximum specified cost.

Policy Amended: 26 May 2020  
Policy Amended: 28 July 2020  
Policy Amended: 23 November 2021

## 1.8 Petty Cash

<b>Policy Type:</b>	Accounting and Finance
<b>Date Adopted:</b>	September 2014

<b>Policy No:</b>	<b>AF008</b>
<b>Date Last Reviewed:</b>	25 October 2022

<b>Legal (Parent):</b>
1.

<b>Legal (Subsidiary):</b>
1.

ADOPTED POLICY	
<b>Title:</b>	<b>PETTY CASH POLICY</b>
<b>Objective:</b>	<b>To provide direction in the appropriate use of petty cash and associated reconciliation.</b>

### Policy

Petty Cash on hand is to be to a maximum of \$100 and is to be securely stored in a locked cash box in the Administration Office safe.

Use of petty cash is restricted to the purchase of incidental items when cash is required and may include Transport Licencing transactions, such as number plate changes, and impromptu donations to charity.

The Senior Administration Officer is to monitor petty cash and reconcile quarterly, with any balancing funds to be drawn from Council's Municipal account by way of cheque requisition.

Appropriate tax invoice or other evidence of petty cash use is to be given to the Senior Administration Officer so that petty cash balance can be reconciled.

Use of petty cash for any purpose is to be authorised by the Chief Executive Officer or in their absence, the Deputy Chief Executive Officer.

## 1.9 Rates – Special Payment Agreements

<b>Policy Type:</b>	Accounting and Finance
<b>Date Adopted:</b>	February 2015

<b>Policy No:</b>	<b>AF009</b>
<b>Date Last Reviewed:</b>	25 October 2022

<b>Legal (Parent):</b>
1.

<b>Legal (Subsidiary):</b>
1.

ADOPTED POLICY	
<b>Title:</b>	<b>SPECIAL PAYMENT AGREEMENTS</b>
<b>Objective:</b>	<b>To Achieve Timely Payment of Rates</b>

### Policy

Where a ratepayer cannot pay their Rates account in full and, for whatever reason, is not able to pay by instalments, they may request to pay by a Special Payment Agreement.

Any Special Payment Agreement is to be authorised by the Chief Executive Officer, who may use their discretion when determining payment amounts and frequency.

However, all payments under a Special Payment Agreement are to be finalised by 30 June in the same rating year.

Any variance to the agreed Special Payment Agreement may lead to the agreement being void.

The Chief Executive Officer may use their discretion in voiding Special Payment Agreements.

Only Current year rates are to be paid by Special Payment Agreement.

Special Payment Agreement payments are to be by direct debit only.

All Rates in arrears are to be cleared before a Special Payment Agreement can be entered into.

Penalty interest at the current interest rate will still be applied to any outstanding amounts.

An Administration Fee of \$30 is to be applied to each Special Payment Agreement.

The Chief Executive Officer to report Special Payment Agreements to Council via the Information Bulletin.

## 1.10 Asset Capitalisation

<b>Policy Type:</b>	Accounting and Finance
<b>Date Adopted:</b>	24 March 2015

<b>Policy No:</b>	<b>AF010</b>
<b>Date Last Reviewed:</b>	25 October 2022

<b>Legal (Parent):</b>
1. Local Government Act 1995

<b>Legal (Subsidiary):</b>
1. Local Government (Financial Management) Regulations 1996

ADOPTED POLICY	
<b>Title:</b>	<b>ASSET CAPITALISATION</b>
<b>Objective:</b>	<b>To establish the method to record Assets</b>

### Policy

Assets are required to be capitalised and recorded on Council's Asset Register

1. Fixed assets less than \$5,000.00 in value (individual or grouped), are to be fully expensed at the time of purchase.
2. Where appropriate, fixed assets of a value less than \$5,000.00 (individual or grouped), are to be recorded in a Small Plant and Equipment Inventory.
3. Fixed assets over \$5,000.00 in value (individual or grouped), are to be classified, recorded in the Asset Register, and depreciated as set out in the Depreciation Policy (AF001).

Policy Amended: 21 February 2017

Policy Amended: 28 August 2018

## 1.11 Related Party Disclosure

<b>Policy Type:</b>	Accounting and Finance
<b>Date Adopted:</b>	22 August 2017

<b>Policy No:</b>	<b>AF011</b>
<b>Date Last Reviewed:</b>	25 October 2022

<b>Legal (Parent):</b>
1. AASB 124

<b>Legal (Subsidiary):</b>
1. Local Government Act 1995
2. Local Government (Financial Management) Regulations 1996.

ADOPTED POLICY	
<b>Title:</b>	<b>RELATED PARTY DISCLOSURE</b>
<b>Objective:</b>	The objective of the Policy is to ensure that the existence of certain related party relationships, related party transactions and information about the transactions, necessary for users to understand the potential effects on the Financial Statements are properly identified, recorded in Council's systems, and disclosed in Council's Annual Financial Report in compliance with AASB 124

### Policy

#### **BACKGROUND**

The relevant standard for the purpose of this Policy is *AASB 124 Related Party Disclosures*, July 2015 (AASB 124).

#### **POLICY STATEMENT**

Council in complying with disclosure requirements in AASB 124, will;

- (1) identify related party relationships, related party transactions and ordinary citizen transactions;
- (2) identify information about the related party transactions for disclosure;
- (3) establish a procedure to capture and record the related party transactions and information about those transactions;
- (4) identify the circumstances in which disclosure is required; and
- (5) determine the disclosures to be made about those items in the Annual Financial Report for the purpose of complying with AASB 124.

Refer to Shire of Beverley Related Party Disclosure Procedure Guidelines.

Policy Amended: 27 August 2019

## 1.12 Rates – Rates Exemption (Non-Rateable Land)

<b>Policy Type:</b>	Accounting and Finance
<b>Date Adopted:</b>	26 June 2018

<b>Policy No:</b>	<b>AF012</b>
<b>Date Last Reviewed:</b>	25 October 2022

<b>Legal (Parent):</b>	1.
------------------------	----

<b>Legal (Subsidiary):</b>	1.
----------------------------	----

ADOPTED POLICY	
<b>Title:</b>	RATES EXEMPTION (NON-RATEABLE LAND)
<b>Objective:</b>	To Apply Rates Exemptions for Non-Rateable Land

### Policy

This policy aims to provide guidance to Council and Council Staff when determining if rate exemption status applies to 'non-rateable land'.

### **Legislation**

All land in an area is rateable unless it is exempt from rating. Rate exemptions may apply under specific circumstances for entities such as public benevolent institutions and public charities.

Rate Exemptions are legislative, and must be compliant. In accordance with the Local Government Act 1995 – 6.26. Rateable Land; (2) The following land is not rateable land -; (g) land used exclusively for charitable purposes.

### **Definition – Charitable Purpose**

A charitable purpose is defined at common law, as it is not currently defined in the Local Government Act 1995. *trusts for the relief of poverty; trusts for the advancement of education; trusts for the advancement of religion; or trusts for other purposes beneficial to the community.*

**Statement** – The Shire of Beverley is committed in assisting Charitable Organisations based within the Shire who provide assistance to members of the public.

Organisations are required to evidence their right to an exemption, and demonstrate the land is used exclusively for charitable purposes.

### **Application of the Policy**

General rules for application will include the following considerations.

Criteria –

An application for Charitable Rate Exemption status must be made in writing by completing a Request for Charitable Rate Exemption Form (Appendix A) and provide any supporting documentation according to the checklist on the application form.

The applicant applying for more than one property must submit a separate application for each property. This supports the principle that it is 'land use', not the applicant that is being assessed.

If the property is leased, a copy of the lease is required with the application.



**Determination**

Applicants will be notified in writing of the Council's decision, with correspondence to include details of: The date the exemption applies from, the section of the LG Act applicable to the exemption, the review period (ie. 2 years); and the amount of general rates reversed. Where exemption from rates is approved, the property will still be subject to the Emergency Services Levy and any other service charges (eg Rubbish collection charges, etc).

**Objection**

An objection should be made by the person named in the rate record as the owner of land or by the agent or attorney of the person. Where the property is leased, it should be by the leasee or by the agent or attorney of that person. Where the application is refused, the applicant may object under s. 6.76 of the Local Government Act 1995, on the basis that the land or part of the land was not rateable land. The applicant has the right to appeal a decision made under s. 6.76 to the State Administrative Tribunal (SAT).

**Reviews**

All properties holding rate exemption status from rates will be subject to reviews at least every 2 years to ensure continued rating exemption.

**Delegation of Authority**

All properties holding rate exemption status applies. Council delegates authority to Chief Executive Officer to approve applications that meet all the eligibility criteria.

**Roles and Responsibilities**

The Chief Executive Officer shall be responsible for the application of delegations of authority in regards to the policy. The Deputy Chief Executive Officer shall be responsible for referring matters to Council in regards to this policy. The Finance Officer, shall be responsible for the review and monitoring of the operation of the policy and be responsible for the day to day operations of the policy.

**Relevant Documents**

Local Government Act 1995 – Section 6.26  
Rates & Charitable Land Use Exemption Applications – WALGA Best Practise Guidelines  
Request for Charitable Rate Exemption Form (Appendix A)

Appendix A



Application for Rates Exemption – Non Rateable Land

**Property Details**

Assessment # \_\_\_\_\_

Property Address - \_\_\_\_\_

**Property Owner Details**

Applicant Name - \_\_\_\_\_

Owner Name (if different from above) - \_\_\_\_\_

Postal Address - \_\_\_\_\_

E-mail Address - \_\_\_\_\_

Contact Phone Number - \_\_\_\_\_

**Applicant Details**

Contact Person \_\_\_\_\_ Position \_\_\_\_\_

Postal Address - \_\_\_\_\_

E-mail Address - \_\_\_\_\_

Contact Phone Number - \_\_\_\_\_

**Current Use of Property**

Please quote which sub-section of the Local Government Act 1995 are you claiming the rates exemption under (see over) - \_\_\_\_\_

What is the Property Used For - \_\_\_\_\_

Signature \_\_\_\_\_ Date \_\_\_\_\_

**Office Use Only**

Title Checked - \_\_\_\_\_

Organisation Incorporated - \_\_\_\_\_

Approved/Denied \_\_\_\_\_ Date \_\_\_\_\_

**Non Rateable Land**

Council can apply rates and charges to all land, with the following exceptions as per section 6.26, subsections s6.26(2) to s6.26(6) of the Local Government Act 1995.

6.26 (2) The following land is not rateable land –

(a) land which is the property of the Crown and –

(i) is being used or held for a public purpose; or

(ii) is unoccupied, except –

(1) Where any person is, under paragraph (e) of the definition of Owners in section 1.4, the owner of the land other than by reason of that person being the holder of a prospecting licence held under the Mining Act 1978 in respect of land the area of which does not exceed 10 ha or a miscellaneous licence held under that Act; or

(2) Where and to the extent and manner in which a person mentioned in paragraph (f) of the definition of owner in section 1.4 occupies or makes use of the land; and

(b) land in the district of a local government while it is owned by the local government and is used for the purposes of the local government other than for purposes of a trading undertaking (as that term is defined in and for the purpose of section 3.59) of the local government; and

(c) land in a district while it is owned by a regional local government and is used for the purposes of the regional local government other than for the purposes of a trading undertaking (as that term is defined in and for the purpose of section 3.59) of the regional local government; and

(d) land used or held exclusively by a religious body as a place of public worship or in relation to that worship, a place of residence of a minister of religion, a convent, nunnery or monastery, or occupied exclusively by a religious brotherhood or sisterhood; and

(e) land used exclusively by a religious body as a school for the religious instruction of children; and

(f) land used exclusively as a non-government school within the meaning of the School Education Act 1999; and

(g) land used exclusively for charitable purposes; and

(h) land vested in trustees for agricultural or horticultural show purposes; and

(i) land owned by Co-operative Bulk Handling Limited or lease from the Crown or a statutory authority (within the meaning of that term in the Financial Management Act 2006) by that company and used solely for the storage of grain where that company has agreed in writing to make a contribution to the local government; and

(j) land which is exempt from rates under any other written law; and

(k) land which is declared by the Minister to be exempt from rates.

(3) If Co-operative Bulk Handling Limited and the relevant local government cannot reach an agreement under subsection (2) (i) either that company or the local government may refer the matter to the Minister for determination of the term of the agreement and the decision of the Minister is final.

(4) The Minister may from time to time, under subsection (2)(k), declare that any land or part of any land is exempt from rates and by subsequent declaration cancel or vary the declaration.

(5) Notice of any declaration made under subsection (4) is to be published in the Gazette.

(6) Land does not cease to be used exclusively for a purpose mentioned in subsection (2) merely because it is used occasionally for another purpose which is of a charitable, benevolent, religious or public nature.

## 1.13 Emergency Hardship Policy – Policy Suspended

<b>Policy Type:</b>	Accounting and Finance
<b>Date Adopted:</b>	28 April 2020

<b>Policy No:</b>	<b>AF013</b>
<b>Date Last Reviewed:</b>	25 October 2022

<b>Legal (Parent):</b>
1.

<b>Legal (Subsidiary):</b>
1.

ADOPTED POLICY	
<b>Title:</b>	<b>EMERGENCY FINANCIAL HARDSHIP POLICY (POLICY SUSPENDED)</b>
<b>Objective:</b>	<b>To ensure that we offer fair, equitable, consistent and dignified support to ratepayers suffering hardship, while treating all members of the community with respect during a community emergency event (not personal emergency).</b>

### Objective

To give effect to our commitment to support the whole community to meet the unprecedented challenges arising from a community wide emergency, the Shire of Beverley recognises that these challenges will result in financial hardship for some.

This Policy is intended to ensure that we offer fair, equitable, consistent and dignified support to ratepayers suffering hardship, while treating all members of the community with respect and understanding at this difficult time.

### Scope

This policy applies to:

1. Rates and service charges levied.

It is a reasonable community expectation, as we deal with the effects of the pandemic that those with the capacity to pay rates will continue to do so. For this reason the Policy is not intended to provide rate relief to ratepayers who are not able to evidence financial hardship and the statutory provisions of the *Local Government Act 1995* and *Local Government (Financial Management) Regulations 1996* will apply.

### Statement

#### **Payment difficulties, hardship and vulnerability\*\*\***

Payment difficulties, or short term financial hardship, occur where a change in a person's circumstances result in an inability to pay a rates or service charge debt.

Financial hardship occurs where a person is unable to pay rates and service charges without affecting their ability to meet their basic living needs, or the basic living needs of their dependants.

The Shire of Beverley recognises the likelihood that an emergency will increase the occurrence of payment difficulties, financial hardship and vulnerability in our community. This policy is intended to

apply to all ratepayers experiencing financial hardship regardless of their status, be they a property owner, tenant, business owner etc.

### **Anticipated Financial Hardship due to an Emergency**

We recognise that many ratepayers are already experiencing financial hardship due to an emergency. We respect and anticipate the probability that additional financial difficulties will arise when their rates are received.

We will write to ratepayers at the time their account falls into arrears, to advise them of the terms of this policy and encourage eligible ratepayers to apply for hardship consideration. Where possible and appropriate, we will also provide contact information for a recognised financial counsellor and/or other relevant support services.

### **Financial Hardship Criteria**

While evidence of hardship will be required, we recognise that not all circumstances are alike. We will take a flexible approach to a range of individual circumstances including, but not limited to, the following situations arising from an emergency situation.

- Recent unemployment or under-employment
- Sickness or recovery from sickness
- Low income or loss of income
- Unanticipated circumstances such as caring for and supporting extended family

Ratepayers are encouraged to provide any information about their individual circumstances that may be relevant for assessment. This may include demonstrating a capacity to make some payment and where possible, entering into a payment proposal. We will consider all circumstances, applying the principles of fairness, integrity and confidentiality whilst complying our statutory responsibilities.

The Chief Executive Officer will have delegated authority (and in consultation with the Rates Officer) to determine whether a hardship case exists or not based on the supporting documents and evidence provided by the applicant.

Supporting documents include:

2 months of payslips showing decrease in hours/pay due to the emergency;

Letter from previous employer stating employment termination due to the emergency;

Statutory Declaration from a person who is being cared for as a result of the emergency;

Medical Certificate noting inability to work/reduction in work ability due to the emergency.

### **Payment Arrangements**

Payment arrangements facilitated in accordance with Section 6.49 of the Act are of an agreed frequency and amount. These arrangements will consider the following:

- That a ratepayer has made genuine effort to meet rate and service charge obligations in the past;
- The payment arrangement will establish a known end date that is realistic and achievable;
- The ratepayer will be responsible for informing the Shire of Beverley of any change in circumstance that jeopardises the agreed payment schedule.

In the case of severe financial hardship, we reserve the right to consider waiving additional charges or interest (excluding the late payment interest applicable to the Emergency Services Levy).

### **Interest Charges**

A ratepayer that meets the Financial Hardship Criteria and enters into a payment arrangement may request a suspension or waiver of interest charges. Applications will be assessed on a case by case basis.

### **Deferment of Rates**

Deferment of rates may apply for ratepayers who have a Pensioner Card, State Concession Card or Seniors Card and Commonwealth Seniors Health Care Card registered on their property. The deferred rates balance:

- remains as a debt on the property until paid;
- becomes payable in full upon the passing of the pensioner or if the property is sold or if the pensioner ceases to reside in the property;
- may be paid at any time, BUT the concession will not apply when the rates debt is subsequently paid (deferral forfeits the right to any concession entitlement); and
- does not incur penalty interest charges.

### **Debt recovery**

We will suspend our debt recovery processes whilst negotiating a suitable payment arrangement with a debtor. Where a debtor is unable to make payments in accordance with the agreed payment plan and the debtor advises us and makes an alternative plan before defaulting on the 3<sup>rd</sup> due payment, then we will continue to suspend debt recovery processes.

Where a ratepayer has not reasonably adhered to the agreed payment plan, then for any Rates and Service Charge debts that remain outstanding, we will offer the ratepayer one further opportunity of adhering to a payment plan that will clear the total debt by the end of the financial year.

Rates and service charge debts that remain outstanding at the end of the financial year, will then be subject to the rates debt recovery procedures prescribed in the *Local Government Act 1995*.

### **Review**

We will establish a mechanism for review of decisions made under this policy, and advise the applicant of their right to seek review and the procedure to be followed.

### **Communication and Confidentiality**

We will maintain confidential communications at all times and we undertake to communicate with a nominated support person or other third party at your request.

We will advise ratepayers of this policy and its application, when communicating in any format (i.e. verbal or written) with a ratepayer that has an outstanding rates or service charge debt.

We recognise that applicants for hardship consideration are experiencing additional stressors, and may have complex needs. We will provide additional time to respond to communication and will communicate in alternative formats where appropriate. We will ensure all communication with applicants is clear and respectful.

### **Summary**

In summary Council delegate the Chief Executive Officer authorisation to:

1. consider offering, upon request, a waiving of interest on outstanding rates between emergency dates, where rates payment will be delayed for those businesses directly affected by Commonwealth and State Government's control measures;
2. consider offering, upon request, a waiving of interest on outstanding rates between emergency dates for those individuals that can demonstrate hardship due to the emergency;

**Policy Suspended: 23 November 2021**

**Policy Changed: 25 October 2022**

## 1.14 Regional Price Preference

<b>Policy Type:</b>	Accounting and Finance
<b>Date Adopted:</b>	28 July 2020

<b>Policy No:</b>	<b>AF014</b>
<b>Date Last Reviewed:</b>	25 October 2022

<b>Legal (Parent):</b>
<ol style="list-style-type: none"> <li>1. Local Government Act 1995 – Sections 3.57, 5.41</li> <li>2. State Records Act 2000</li> </ol>

<b>Legal (Subsidiary):</b>
<ol style="list-style-type: none"> <li>1. Local Government (Functions and General) Regulations 1996 – Part 4A Regional price Preference.</li> </ol>

ADOPTED POLICY	
<b>Title:</b>	<b>REGIONAL PRICE PREFERENCE</b>
<b>Objective:</b>	<b>To promote and support local businesses and the community by giving preferential consideration to Regional Businesses and Regional Content when considering the provision of goods and services via tender and quotation.</b>

### Policy

#### **Regional Business Preference**

This preference enables businesses within the Prescribed Area to claim a price preference for their whole bid.

The preference will apply to all quotations of \$10,000 or greater, and all tenders invited by the Shire of Beverley.

To qualify as a Regional Business, a business must meet the following conditions:

1. A permanent office in the Prescribed Area for at least six (6) months prior to the closing date of tenders/quotations.
2. Permanent Staff based in the prescribed area.
3. The Regional Business is required to provide written evidence within the quotation/tender submission which demonstrates compliance with condition 1 and 2.

#### **Regional Content Preference**

This preference enables businesses not located within the Prescribed Area to claim a price preference for the goods and/or services purchased from within the Prescribed Area.

Note: Travel and accommodation costs associated with sending Staff/Sub Contractors from outside the Prescribed Area to work on a regional contract, are not considered regional content and are not eligible for the "Regional Content Preference".

The preference will apply to all quotations of a collective value of \$10,000 or greater, and all tenders invited by the Shire of Beverley. Businesses wishing to claim the Regional Content Preference are required to provide written evidence as described within the request for quotation/tender documentation. Businesses outside the Prescribed Area, who claim that they will use Regional Content in the delivery of the contract outcomes, will be required, as part of the contract conditions, to demonstrate that they have actually used them.



### **Price Preference**

Preference will be given to a regional business by assessing their submission as if the price bids were reduced by:

- (a) 10% (up to a maximum price reduction of \$50,000) for goods and services; or
- (b) 5% (up to a maximum price reduction of \$50,000) for construction (building) services ; or
- (c) 10% (up to a maximum of \$500,000) for goods or services including construction (building), if Council is seeking tenders for the provision of those goods or services for the first time, due to those goods or services having been, until then, undertaken by Council.

### **Value for Money**

Whilst price is a competitive consideration in the provision of goods and services via quotation and/or tender, it is only one aspect of the evaluation process. Value for Money principles, as described within AF007 Purchasing and Procurement will be employed by assessing the price component in conjunction with the quotation/tender selection criteria and requirements.

### **Prescribed Area**

The Prescribed area is the Wheatbelt sub-region of Avon. The Avon area is the Shires of Beverley, Cunderdin, Dowerin, Goomalling, Northam, Quairading, Tammin, Toodyay and York.

### **Responsibilities**

The Shire of Beverley, where practicable will:

1. Ensure that the application of a local price preference is clearly identified within the quote or tender documentation to which the preference is to be applied.
2. Operate this policy in conjunction with the Shire of Beverley Purchasing and Procurement Policy AF007 for tenders and quotations when evaluating and awarding contracts.

### **Legislation**

*Local Government (Function and General) Regulations 1996 Part 4A* were amended to allow non-metropolitan local governments to offer a price preference to regional suppliers when deciding which Tender to accept. A price preference can only be applied if a local government authority has advertised and adopted a regional price preference policy.

## 2. Administration

### 2.1 Policy Manual

<b>Policy Type:</b>	Administration
<b>Date Adopted:</b>	September 2014

<b>Policy No:</b>	<b>A001</b>
<b>Date Last Reviewed:</b>	25 October 2022

<b>Legal (Parent):</b>	1.
------------------------	----

<b>Legal (Subsidiary):</b>	1.
----------------------------	----

ADOPTED POLICY	
<b>Title:</b>	<b>POLICY MANUAL</b>
<b>Objective:</b>	<b>To effectively review the Policy Manual.</b>

#### Policy

Council shall maintain a manual and up to date recording of the various policies of Council.

1. Additions, deletions and amendments to Council policy shall only be effected by an absolute majority of Council.
2. A review of the Policy Manual shall be conducted annually, and as and when a policy is varied by Council.
3. The Policy Manual shall be available for public inspection and comment free of charge at the Shire Administration Office. Copies will be made available for sale at a cost set by the Shire of Beverley's current fees and charges.

Policy Updated: 25 October 2016

## 2.2 Legal Advice

<b>Policy Type:</b>	Administration
<b>Date Adopted:</b>	September 2014

<b>Policy No:</b>	<b>A002</b>
<b>Date Last Reviewed:</b>	25 October 2022

<b>Legal (Parent):</b>
1.

<b>Legal (Subsidiary):</b>
1.

<b>ADOPTED POLICY</b>	
<b>Title:</b>	<b>LEGAL ADVICE</b>
<b>Objective:</b>	<b>To allow the Chief Executive Officer to seek legal advice.</b>

### Policy

The Chief Executive Officer is authorised to obtain from solicitors or barristers such legal advice and opinion as is deemed necessary to enable the proper legal administration of Council's business and in support of a report or submission to Council or a Committee on matters which require advice from legal authority.

Policy Amended: 25 October 2022

## 2.3 Risk Management

<b>Policy Type:</b>	Administration
<b>Date Adopted:</b>	December 2014

<b>Policy No:</b>	<b>A003</b>
<b>Date Last Reviewed:</b>	25 October 2022

<b>Legal (Parent):</b>
1.

<b>Legal (Subsidiary):</b>
1.

ADOPTED POLICY	
<b>Title:</b>	<b>RISK MANAGEMENT</b>
<b>Objective:</b>	<b>The Shire of Beverley (“the Shire”) Risk Management Policy documents the commitment and objectives regarding managing uncertainty that may impact the Shire’s strategies, goals or objectives.</b>

### **Policy**

It is the Shire’s Policy to achieve best practise (aligned with AS/NZS ISO 31000: 2009 Risk Management), in the management of all risks that may affect the Shire, its customers, people, assets, functions, objectives, operations or members of the public.

Risk Management will form part of the Strategic, Operational, Project and Line Management responsibilities and where possible, be incorporated within the Shires Integrated Planning Framework.

The Shire’s Management Team will determine and communicate the Risk Management Policy, Objectives and Procedures, as well as, direct and monitor implementation, practise and performance.

Every employee within the Shire is recognised as having a role in risk management from the identification of risks to implementing risk treatments and shall be invited and encouraged to participate in the process.

Consultants may be retained at times to advise and assist in the risk management process, or management of specific risks or categories of risk.

**The Risk Management Governance Framework document, outlines the full Risk Management Policy and Procedures.**

Policy Amended: 27 August 2019

## 2.4 Public Interest Disclosure

<b>Policy Type:</b>	Administration
<b>Date Adopted:</b>	September 2014

<b>Policy No:</b>	<b>A004</b>
<b>Date Last Reviewed:</b>	25 October 2022

<b>Legal (Parent):</b>
1. Public Interest Disclosure Act 2003

<b>Legal (Subsidiary):</b>
1.

ADOPTED POLICY	
<b>Title:</b>	<b>PUBLIC INTEREST DISCLOSURE</b>
<b>Objective:</b>	<b>To comply with necessary obligations under the Public Interest Disclosure Act 2003.</b>

### Policy

#### **Support for Staff who make Public Interest Disclosures**

The Shire of Beverley does not tolerate corrupt or other improper conduct, including mismanagement of public resources, in the exercise of the public functions of the Shire of Beverley and its officers, employees and contractors.

The Shire of Beverley is committed to the aims and objectives of the *Public Interest Disclosure Act 2003*. It recognises the value and importance of contributions of staff to enhance administrative and management practices and strongly supports disclosures being made by staff as to corrupt or other improper conduct.

The Shire of Beverley will take all reasonable steps to provide protection to staff that make *such* disclosures from any detrimental action in reprisal for the making of a public interest disclosure.

The Shire of Beverley does not tolerate any of its officers, employees or contractors *engaging* in acts of victimisation or reprisal against those who make public interest disclosures.

These internal procedures provide for the manner in which the Shire of Beverley will comply with its obligations under the *Public Interest Disclosure Act 2003*.

They provide for the manner in which:

- disclosures of public interest information shall be made to the Public Interest Disclosure Officer (PID Officer).
- the PID Officer shall investigate the information disclosed, or cause that information to be investigated.
- the PID Officer may take action following the completion of the investigation.
- the PID Officer shall report to the discloser as to the progress and outcome of that investigation and the action taken as a consequence.
- the confidentiality of the discloser, and any person who may be the subject of a public interest disclosure, shall be maintained.
- records as to public interest disclosures shall be maintained and reporting obligations complied with.

**Object of the Act**

The Public Interest Disclosure Act 2003 commenced operation on 1 July 2003. The object of the Act is to:

- facilitate the disclosure of public interest information;
- provide protection for those who make disclosures; and
- provide protection for those who are the subject of a disclosure.

This is achieved by:

- protecting the person making the disclosure from legal or other action;
- providing for the confidentiality of the identity of the person making the disclosure and a person who is the subject of a disclosure; and
- providing remedies for acts of reprisal and victimisation that occur substantially because the person has made a disclosure.

The rights and obligations created by the Act are described in Appendix 1 to these Procedures.

[Note for Public Authorities:

***The text at Part I of these Guidelines should be reproduced as an Appendix to the Internal Procedures, for the information of PID Officers and staff and customers of the public authority]***

**Designation of Public Interest Disclosure (PID) Officer**

The person from time to time holding or acting in the position of **Deputy Chief Executive Officer** is designated as the Public Interest Disclosure Officer, or PID Officer, of the Shire of Beverley. The PID Officer is responsible for receiving disclosures of public interest information relating to matters falling within the sphere of responsibility of the Shire of Beverley.

The contact details of the PID Officer are as follows:

**Deputy Chief Executive Officer**  
**PO Box 20**  
**BEVERLEY WA 6304**

**Phone: 9646 1200                      Fax: 9646 1409**  
**dceo@beverley.wa.gov.au**

After assuming or beginning to act in the position of **Deputy Chief Executive Officer** the person holding or acting in that position must forward a completed PID Officer's Declaration (see FORMS) to the Office of the Public Sector Standards Commissioner. A copy of the completed PID Officer's Declaration shall be retained on a file to be kept for that purpose.

The person holding or acting in the position of **Deputy Chief Executive Officer** at the commencement of these procedures shall forward a completed PID Officer's Declaration to the Office of the Public Sector Standards Commissioner as soon as is practicable. A copy of the completed PID Officer's Declaration shall be retained on a file to be kept for that purpose.

**Corruption and Crime Commission**

The Act also provides for the Corruption and Crime Commission to receive public interest disclosures of information relating to an offence under State law. Subsequent references in these procedures to the PID Officer shall be taken to include an employee or officer of the Commission who receives, on behalf of the Commission, information relating to an offence under State law.

**Police**

The Act also provides for any police officer to receive public interest disclosures of information relating to an offence under State law. Subsequent references in these procedures to the PID Officer shall be taken to include an officer who receives a public interest disclosure relating to an offence under State law.

**Ombudsman**

The Act also provides for the Ombudsman to receive public interest disclosures of information relating to matters of administration within the jurisdiction of the Ombudsman, and matters relating to most public officers. Subsequent references in these procedures to the PID Officer shall be taken to include an officer of the Ombudsman who receives, on behalf of the Ombudsman, information relating to these matters.

**Auditor General**

The Act also provides for the Auditor General to receive public interest disclosures of information relating to substantial unauthorised or irregular use of, or substantial mismanagement of, public resources. Subsequent references in these procedures to the PID Officer shall be taken to include a person appointed by the Auditor General who receives, on behalf of the Auditor General information relating to these matters.

**Receiving Public Interest Disclosures**Advice to Disclosers

Before a discloser makes a public interest disclosure to a PID Officer, the PID Officer shall advise the discloser of the following matters:

If they choose to make a public interest disclosure they will not as a result

- incur any civil or criminal liability.
- be liable to any disciplinary action under State law.
- be liable to be dismissed or have his or her services dispensed with or otherwise terminated.
- be liable for any breach of a duty of secrecy or confidentiality or any other applicable restriction on disclosure.

If they choose to make a public interest disclosure they may have the right to take civil proceedings if they are subject to detrimental action as a result of making the disclosure.

If they choose to make a public interest disclosure then their identity will not be disclosed except in accordance with the Act (disclosure of their identity may be required in the course of the investigation or in taking action in some circumstances).

If they choose to make a public interest disclosure then they will have the right to be informed of the progress and outcome of the investigation and action taken as a result.

If they choose to make a public interest disclosure:

- They are only protected if they believe on reasonable grounds that the information to be disclosed is or may be true;
- They will commit an offence, and lose the protection of the Act, if they know the information to be false or misleading in a material particular or are reckless about whether the information is false or misleading in a material particular.
- They will forfeit the protection given by the Act if they disclose the information otherwise than under the Act (ie if they provide the information to the media or a person who is not a proper authority).
- They will forfeit the protection given by the Act if they fail, without reasonable excuse, to assist a person investigating the matter to which the information relates, by supplying any information requested.

They may commit an offence if they disclose information that might identify or tend to identify anyone as a person in respect of whom a disclosure of public interest information has been made.

The disclosure will only be protected if the PID Officer is the proper authority for receiving that kind of information, as indicated in the following table:

Proper Authorities for Receiving  
Disclosures of Public Interest Information

When the disclosure relates to...	the proper authority is...
The sphere of responsibility of a public authority (eg matters about the public authority or its officers, or which the public authority has the function of investigating)	The Public Interest Disclosure Officer (PID Officer) of the Public Authority
Offences under State law.	A police officer or the Corruption and Crime Commission
Substantial unauthorised or irregular use of, or substantial mismanagement of, public resources	The PID Officer of the public authority concerned, or the Auditor General
Matters of administration affecting someone in their personal capacity falling within the jurisdiction of the Ombudsman	The PID Officer of the public authority concerned or the Ombudsman
A police officer	The Commissioner of Police or the Corruption and Crime Commission
A Member of the Legislative Council	The President of the Legislative Council
A Member of the Legislative Assembly	The Speaker of the Legislative Assembly
A judicial officer	The Chief Justice
A public officer who is not a member of Parliament, a Minister, a Judicial Officer or a Commissioned or other officer specified in schedule 1 of the Parliamentary Commissioner Act 1971	The PID Officer of the public authority concerned, the Ombudsman or the Commissioner for Public Sector Standards
A person or a matter of a prescribed class	A person declared by the regulations to be a proper authority

**Important Note:** In addition, the information disclosed must be public interest information as defined in the Act. Not all proper authorities to which a disclosure may be made will be required or have the power to investigate the information disclosed. In some cases it may be necessary for the discloser or information to be referred to another proper authority with power to investigate the information.

**Assessing a Public Interest Disclosure**

The PID Officer must, on receiving the information confirm that the discloser, after receiving the advice referred to in section 1, wishes to make a public interest disclosure under the Act. If they do the PID Officer must make an initial assessment of whether:

- the information disclosed relates to a public authority, a public officer or a public sector contractor.
- the information disclosed relates to the performance of a public function.
- the information disclosed tends to show improper conduct.
- the improper conduct is of the kind for which the PID Officer is the proper authority (see the table in section 1).
- the discloser believes on reasonable grounds that the information is or may be true.
- the information is not protected by legal professional privilege.

If the above questions are all answered "yes", then the disclosure of information is a public interest disclosure to which the Act will apply.

In assessing whether a disclosure is a public interest disclosure, the PID Officer should consider the *Flowchart for Receiving Disclosures* at Appendix 2, as well as complete Part 1 of the *Assessment Form Public Interest Disclosure* at Appendix 5.



### **Form of Public Interest Disclosure**

If a disclosure is a public interest disclosure, the discloser and the PID Officer should complete the *Public Interest Disclosure Lodgement Form* (see FORMS). The PID Officer should also complete Part 2 of the *Assessment Form For Public Interest Disclosures* (see FORMS).

On completion of this form, the PID Officer should create a separate file for the Public Interest Disclosure, with the following text clearly marked on the front of the File.

### **“CONFIDENTIAL**

**The material in this file relates to a public interest disclosure made under the *Public Interest Disclosure Act 2003***

**Disclosure of information that might identify or tend to identify either the discloser or a person in respect of whom the disclosure has been made is an offence, unless the disclosure occurs in accordance with the Act.**

**Penalty: \$24,000 or imprisonment for two years”**

The making of the public interest disclosure should also be recorded in the Public Interest Disclosure Register, described in section J of these Procedures, for reporting to the Commissioner for Public Sector Standards.

- F. Investigating a Public Interest Disclosure
- 1. Determining whether the matter must be investigated

After receiving a disclosure, the PID Officer must consider whether:

- the disclosure relates to the Shire of Beverley, its officers or contractors.
- the disclosure relates to a matter or person that Shire of Beverley has a function or power to investigate.

If the answer to both of these questions is “no”, the PID Officer is not required by the Act to investigate the matter.

Where the PID Officer considers that he or she lacks sufficient power to effectively investigate the matter, but the information received causes him or her to form the opinion that a public authority, public officer or public sector contractor may have engaged in improper conduct, the PID Officer should refer the matter to another appropriate investigative body. For example, an allegation of an offence supported by cogent evidence may need to be referred by a PID Officer to the Police for investigation.

The PID Officer must also consider whether:

- the matter is trivial.
- the disclosure is vexatious or frivolous.
- there is no reasonable prospect of obtaining sufficient evidence due to the time that has elapsed since the occurrence of the matter.
- the matter is being or has been adequately or properly investigated by another proper authority to which an appropriate disclosure of public interest information has been made under the Act.

If the answer to any of these questions is “yes”, the PID Officer is not required by the Act to investigate the matter.

The questions to be considered in the initial assessment by the PID Officer are indicated in the *Flowchart for Investigating Information Disclosed* at Appendix 3, and Part 1 of the *Assessment Form for Public Interest Disclosures* (see FORMS) should be completed.

In assessing whether a public interest disclosure should be investigated, a PID Officer should consider the *Flowchart for Investigating Information Disclosed* (Appendix 3) and complete Part 3 of the *Assessment Form for Public Interest Disclosures* (see FORMS).

## 2. Investigating information received in a Public Interest Disclosure

Where the PID Officer determines that the disclosure is a public interest disclosure that should be investigated, the officer must investigate the disclosed matter himself or herself or engage another person to carry out the investigation.

In conducting an investigation, typical procedures could include:

- Drawing up terms of reference, which should clarify the key issues identified by the disclosure.
- Specifying a date by which the investigation should be completed.
- Ensuring the objectives of the investigation include collecting and collating information relating to the disclosure, considering the information collected and drawing conclusions objectively and impartially.
- Maintaining procedural fairness for the person who is the subject of the disclosure.
- Giving information to the person who is the subject of a disclosure about their rights and obligations under the Act, the Code of Conduct and Integrity, any agency code of conduct, and the law.
- The investigator making contemporaneous notes of discussions and interviews and, where practicable and appropriate, recording discussions and interviews on audio or videotape.
- Ensuring strict security with all investigations, so as to maintain the confidentiality requirements of the Act.

If a disclosure is withdrawn, a proper authority may still continue to investigate the issues raised.

### **Maintaining Confidentiality in an Investigation**

The Act imposes strict confidentiality requirements in relation to the identity of the discloser and persons in respect of whom a public interest disclosure has been made. The disclosure of information which might identify or tend to identify these persons, except in accordance with the Act, is a serious offence, punishable with a maximum penalty of \$24,000 or two years imprisonment.

The confidentiality provisions of the Act do not apply to all information disclosed in a public interest disclosure, but only to information that might identify or tend to identify the discloser and persons in respect of whom a public interest disclosure has been made.

One of the circumstances in which identifying information may be disclosed is with the consent of the person concerned. It is important that this consent be recorded. The *Consent to Disclosure of Identifying Information* form should be used for this purpose (see FORMS).

Identifying information relating to a discloser may be disclosed without the discloser's consent where:

- it is necessary to do so, having regard to the rules of natural justice; or
- it is necessary to do so to enable the matter to be investigated effectively.

However, before information is disclosed for these reasons the person making the disclosure must take all reasonable steps to inform the person whose identity is to be disclosed:

- that the disclosure is being made; and
- the reasons for the disclosure being made.

This information should be given, where practicable, in the form for *Notification of Disclosure of Identifying Information* (see FORMS).

Where identifying information in relation to a discloser is conveyed to another person for these reasons, the other person should be warned that disclosure of the information to a third person may involve a serious offence.

Identifying information relating to a person in respect of whom a public interest disclosure has been made can be disclosed at the investigation stage where the disclosure:

- is necessary to enable the matter to be investigated effectively;
- there are reasonable grounds to believe that the disclosure of identifying information is necessary to prevent or minimise the risk of injury to any person or damage to any property.

In addition, disclosures made in accordance with section 152 or 153 of the *Corruption and Crime Commission Act* are exempt from these confidentiality requirements.

Particularly where a discloser works for the Shire of Beverley, protecting the identity of the discloser is an important part of protecting the discloser from reprisals and victimisation. Careful consideration must be given as to whether the disclosure of information that might identify or tend to identify a discloser is necessary for the effective investigation of the matter or having regard to the rules of natural justice.

Where a PID Officer appoints a third person to conduct an investigation in relation to the public interest disclosure, he or she must consider whether it is necessary to inform the investigator of the identity of the discloser. In some cases it may not be necessary to provide the investigator with the identity of the discloser. Where it is necessary, to enable an effective investigation, or having regard to the rules of natural justice, to provide identifying information to the investigating officer, then the discloser should be notified in the manner described above.

### **Recording the Outcome of an Investigation**

The outcome of an investigation should be clearly and comprehensively recorded. In addition to any investigation report, the person conducting the investigation should complete part 4 of the *Assessment Form for Public Interest Disclosure* (see FORMS).

The result of the investigation should also be recorded in the Public Interest Disclosure Register, described in section J of these Procedures (sample Register is provided as Appendix 5). All reporting requirements to the Commissioner for Public Sector Standards required under the Act will be based on extracts from this Register.

## **G. Taking Action Following an Investigation**

### **1. General**

The PID Officer must take action where he or she forms the opinion that a person may be, or has been or may in the future be, involved in improper conduct. Action that may be taken includes:

- preventing the matter to which the disclosure relates from continuing or occurring
- referring the matter to the Police or other appropriate body, or
- taking disciplinary action against a person responsible for the matter.

Before taking any action, the person against whom the action is to be taken is to be given the opportunity to make written or oral submissions.

In taking that action the PID Officer remains limited by the powers and functions that are conferred by the legislation under which the Officer operates. The Act does not give the PID Officer additional powers to take action.

As well as being limited to matters within the functions and powers of the PID Officer, the action to be taken is guided by what is necessary and reasonable.

### **Maintaining Confidentiality when Taking Action**

When taking action, the confidentiality of identifying information must be maintained, unless its disclosure is authorised by the Act.

The only additional exception, beyond those identified in relation to investigations, is where disclosure of the identity of a person who is the subject of a public interest disclosure is necessary in taking action following the investigation.

### **Recording Action Taken**

In addition to keeping other records, the PID Officer shall complete Part 5 of the *Assessment Form for Public Interest Disclosures* (see FORMS) and record a summary of the action taken in the Public Interest Disclosure Register. All reporting requirements to the Commissioner for Public Sector Standards required under the Act will be based on extracts from this Register.

## **H. Reporting to a Discloser on the Progress and Outcome of an Investigation**

Where the PID Officer decides not to investigate information disclosed under the Act, or discontinues an investigation, the Officer must give the person who made the disclosure reasons for doing so.

Within three months of the disclosure being made the PID Officer must notify the discloser of the action taken or proposed to be taken in relation to the disclosure.

A discloser may also request a progress report.

If an investigation is not complete, the PID Officer may provide to the discloser a progress report on the current status of the investigation.

If an investigation is complete, the PID Officer must provide a final report to the discloser, stating the outcome of the investigation and the reason for taking action following the investigation.

In providing information and reports to disclosers, the PID Officer must not give information that, in the officer's opinion, would be likely to adversely affect:

- any person's safety;
- the investigation of an offence or possible offence; or
- necessary confidentiality as to the existence or identity of another person who has made a disclosure of public interest information under the Act.

### **Protecting Disclosers**

#### **Victimisation and Reprisals**

The Shire of Beverley will not tolerate any acts of victimisation or reprisal as a result of a person making, or proposing to make, a public interest disclosure.

Any victimisation or reprisals must be reported immediately to the Chief Executive Officer or the PID Officer, who must take immediate action to prevent the continuance of this unlawful conduct.

Where victimisation or reprisals are reported, a record of the report and the action taken must be placed on the file relating to the public interest disclosure.

Steps taken to prevent acts of victimisation or reprisal should be recorded in a manner that they will be accessible for reference, should legal action be taken against the Shire of Beverley.

#### **Confidentiality**

The confidentiality requirements in relation to information which might identify or tend to identify a discloser or a person in respect of whom a public interest disclosure has been made must be complied with at all times. As noted above, the disclosure of this identifying information, except in accordance with the Act, is an offence.

All files relating to a public interest disclosure, whether paper or electronic, must be secure and accessible only by authorised persons. Files should carry clear warnings that there are penalties for unauthorised divulgence of information concerning a disclosure.

It is strongly recommended that sensitive information is not emailed or faxed to machines with general or shared access.

### **Public Interest Disclosure Register**

The Shire of Beverley shall maintain a Public Interest Disclosure Register recording a unique register number and key information for each disclosure.

- The register should include a summary of information relating to:
- The discloser
- Public authorities about which a disclosure is made
- People named in the disclosure
- The nature of the disclosure
- The investigation process and the action, if any, taken
- Communication with the discloser
- Disclosure of the discloser's identity, if applicable
- Disclosure of identity of persons named in the disclosure
- Claims of unlawful disclosure of discloser's identity or identity of persons named in the disclosure
- Claims of victimisation
- Key dates

A sample *Public Interest Disclosure Register* is provided at Appendix 5. An electronic version can be found on the website at [www.opssc.wa.gov.au/pid](http://www.opssc.wa.gov.au/pid). Additional information may also be recorded in the Register at the discretion of the public authority.

All reporting requirements to the Commissioner for Public Sector Standards required under the Act will be based on extracts from the fields shown in the sample Register.

### **Reporting Requirements**

Under the Act public authorities will need to report to the Commissioner each year as outlined below.

#### Principal Executive Officer Report

Under section 23 (f) of the Act, the Shire of Beverley is required to report annually to the Commissioner for Public Sector Standards on:

- **the number of public interest disclosures received over the report period;**
- **the results of any investigations conducted as a result of the disclosures; and**
- **the action, if any, taken as a result of each investigation.**
- **Commissioner's Compliance Report**

Under section 19 and 22 of the Act, the Commissioner is required to monitor compliance with the Act, to assist public authorities to comply with the Act and the Code and to provide an Annual Report to Parliament.

Under section 27 of the Act the Minister will carry out a review of the Act in 2006.

To enable the Commissioner and the Minister to meet these obligations Shire of Beverley will provide a report each year on compliance with and administration of the Act as requested by the Commissioner.

### **Report Format and Submission**

An electronic format for the Principal Executive Officer Report and the information for the Commissioner's Compliance Report will be provided each year by the Commissioner and both will be able to be submitted in a single electronic submission. The reports will cover the period 1 July in any year to 30 June in the subsequent year.

Where there has been no action on a disclosure in the reporting period the format of the report will provide for a simple nil return. Where action relating to one or more disclosures has occurred, all data required will be obtainable as a simple extract from the Public Interest Disclosure Register.

**Making Information Available**

These internal procedures shall be made available for access by all staff and members of the public. Copies of these internal procedures are available from the Public Interest Disclosure Officer and are to be kept at the:

**Shire of Beverley  
Administration Building  
136 Vincent Street  
BEVERLEY WA 6304.**

After the commencement of the Act all staff should be provided with the *Information for Staff* at Appendix 6. This information should also be provided to new staff on induction.

Where a person makes an allegation about improper conduct, but the person has not referred to the Act, the person should be advised that they might want to make a public interest disclosure under the Act. If they may wish to do so, they should be referred to the PID Officer for guidance on how to make a disclosure under the Act and on the implications of having done so.

## 2.5 Workforce Planning and Management Policy

<b>Policy Type:</b>	Administration
<b>Date Adopted:</b>	26 May 2015

<b>Policy No:</b>	<b>A005</b>
<b>Date Last Reviewed:</b>	25 October 2022

<b>Legal (Parent):</b>
1. Local Government Act 1995

<b>Legal (Subsidiary):</b>
1.

ADOPTED POLICY	
<b>Title:</b>	<b>WORKFORCE PLANNING AND MANAGEMENT POLICY</b>
<b>Objective:</b>	<b>To ensure that strategic, operational and legislative objectives are met by effective workforce planning and resourcing to demonstrate compliance with the Integrated Planning requirements of the Local Government Act (1995) Regulation S5.56(2).</b>

### Policy

Workforce planning is a continuous process of shaping the workforce to ensure it is capable of delivering organisational objectives into the future. It provides the framework for assessing the demand and supply of the workforce and aims to have the right people in the right place at the right time to affect the delivery of organisational goals, resourced through effective long term financial and business plans.

#### Principles – Framework - Process

The Shire considers workforce planning to be an essential management function in its operations. They recognise that the achievement of all goals and objectives are reliant on the appropriate capacity, skills, knowledge of the workforce.

Council is committed to resourcing workforce requirements through its integrated planning processes.

Council also recognises that the responsibility for managing people lies with the person who has the executive responsibility for the objectives of the service/activity/ function of their division.

The Shire will ensure the Workforce Plan addresses current and future best practice human resource management practices that include effective and efficient recruitment and retention; performance management, training and development; legislative compliance; occupational safety and health; support and encouragement.

### **Responsibilities**

- Executive, managers and supervisors have the responsibility and accountability for ensuring that all staff are managed appropriately within their own work areas.
- In each of these areas, current and future demand and supply should be assessed as part of the annual and strategic planning cycles.
- All managers will ensure effective setting of KPIs and performance criteria for their staff that will meet relevant organisational objectives.
- Staff appraisals will incorporate training and development plans to ensure the current and future skills and knowledge needs are met wherever practicable, with gaps and omissions reported to the DCEO and/ or the Human Resources Officer for inclusion in the Workforce Plan.
- The Human Resources officer will collect and monitor workforce relevant workforce data and statistics.

- The relevant organisational planning and performance monitoring personnel will research relevant workforce data, demographics and trends as part of the integrated planning cycle.
- All elected members and staff involved in organisational, operational or project planning will ensure that workforce implications are considered and included in all strategic or operational plans.

**Monitor and review**

The Organisation will implement a robust reporting and recording system that will be regularly monitored to ensure human resource supply and demand management is appropriately implemented and sustained across the organisation and there is ongoing identification of issues and trends.

Workforce planning's key performance indicators, relating to both organisational and personal performance will be developed, implemented and monitored, by the Shire's Executive and Council as appropriate.



## 2.6 Habitual or Vexatious Complaints

<b>Policy Type:</b>	Administration
<b>Date Adopted:</b>	September 2014

<b>Policy No:</b>	<b>A006</b>
<b>Date Last Reviewed:</b>	25 October 2022

<b>Legal (Parent):</b>
1.

<b>Legal (Subsidiary):</b>
1.

ADOPTED POLICY	
<b>Title:</b>	<b>HABITUAL OR VEXATIOUS COMPLAINTS</b>
<b>Objective:</b>	<b>To provide guidelines for employees to determine what is a habitual or vexatious complaint and how to deal with it.</b>

### Policy

#### **Habitual or Vexatious Complainants**

- For the purpose of this policy, the following definition of habitual or vexatious complainants will be used:

The repeated and/or obsessive pursuit of:

- (i) Unreasonable complaints and/or unrealistic outcomes; and/or
  - (ii) Reasonable complaints in an unreasonable manner.
- Where complaints continue and have been identified as habitual or vexatious in accordance with the criteria set out in the attached document (Schedule A), the CEO, following discussions with the Senior Management Team, will seek agreement to treat the complainant as a habitual or vexatious complainant and for an appropriate course of action to be taken. The attached schedule (B) details the options
  - The CEO will notify complainants, in writing, of the reasons why their complaint has been treated as habitual or vexatious, and the action that will be taken. *The CEO will also notify the Council Members that a constituent has been designated as a habitual or vexatious complainant.*
  - Once a complainant has been determined to be habitual or vexatious, their status will be kept under review *after one year* and monitored by the CEO with reports being taken to Council as required. If a complainant subsequently demonstrates a more reasonable approach then their status will be reviewed.

**Schedule A – Criteria for Determining Habitual or Vexatious Complaints**

Complainants (and/or anyone acting on their behalf) may be deemed to be habitual or vexatious where previous or current contact with them shows how they meet one of the following criteria:

Where complainants:

1. Persist in pursuing a complaint where the Council's complaints process has been fully and properly implemented and exhausted.
2. Persistently change the substance of a complaint or continually raise new issues or seek to prolong contact by continually raising further concerns or questions whilst the complaint is being addressed. (Care must be taken, however, not to disregard new issues which are significantly different from the original complaint as they need to be addressed as separate complaints).
3. Are repeatedly unwilling to accept documented evidence given as being factual or deny receipt of an adequate response in spite of correspondence specifically answering their questions or do not accept that facts can sometimes be difficult to verify when a long period of time has elapsed.
4. Repeatedly do not clearly identify the precise issues which they wish to be investigated, despite reasonable efforts of the Council to help them specify their concerns, and/or where the concerns identified are not within the remit of the Council to investigate.
5. Regularly focus on a trivial matter to an extent which is out of proportion to its significance and continue to focus on this point. It is recognized that determining what is a trivial matter can be subjective and careful judgment will be used in applying this criteria.
6. Have threatened or used physical violence towards employees at any time. This will, in itself, cause personal contact with the complainant and/or their representative to be discontinued and the complaint will, thereafter, only be continued through written communication. The Council has determined that any complainant who threatens or uses actual physical violence towards employees will be regarded as a vexatious complainant. The complainant will be informed of this in writing together with notification of how future contact with the Council is to be made.
7. Have, in the course of addressing a registered complaint, had an excessive number of contacts with the Council – placing unreasonable demands on employees. A contact may be in person, by telephone, letter, email or fax. Judgment will be used to determine excessive contact taking into account the specific circumstances of each individual case.
8. Have harassed or been verbally abusive on more than one occasion towards employees dealing with the complaint. Employees recognize that complainants may sometimes act out of character in times of stress, anxiety or distress and will make reasonable allowances for this. *Some complainants may have a mental health disability and there is a need to be sensitive in circumstances of that kind.*
9. Are known to have recorded meetings or face-to-face/telephone conversations without the prior knowledge and consent of other parties involved.
10. Make unreasonable demands on the Council and its employees and fail to accept that these may be unreasonable, for example, insist on responses to complaints or enquiries being provided more urgently than is reasonable or within the Council's complaints procedure or normal recognized practice.
11. Make unreasonable complaints which impose a significant burden on the human resources of the Council and where the complaint:
  - Clearly does not have any serious purpose or value; or
  - Is designed to cause disruption or annoyance; or
  - Has the effect of harassing the public authority; or
  - Can otherwise fairly be characterized as obsessive or manifestly unreasonable.

12. Make repetitive complaints and allegations which ignore the replies which Council Officers have supplied in previous correspondence.

**Schedule B – Options for Dealing with Habitual or Vexatious Complainants**

The options below can be used singularly or in combination depending on the circumstances of the case and whether the complaint process is ongoing or completed.

1. A letter to the complainant setting out responsibilities for the parties involved if the Council is to continue processing the complaint. If terms are contravened, consideration will then be given to implementing other action as indicated below.
2. Decline contact with the complainant, either in person, by telephone, by fax, by letter, by email or any combination of these, provided that one form of contact is maintained. This may also mean that only one named officer will be nominated to maintain contact (and a named deputy in their absence). The complainant will be notified of this in person.
3. Notify the complainant, in writing, that the Council has responded fully to the points raised and has tried to resolve the complaint but there is nothing more to add and continuing contact on the matter will serve no useful purpose. The complainant will also be notified that the correspondence is at an end, advising the complainant that they are being treated as a habitual or vexatious complainant and as such the Council does not intend to engage in further correspondence dealing with the complaint.
4. Inform the complainant that in extreme circumstances the Council will seek legal advice on habitual or vexatious complaints.
5. Temporarily suspend all contact with the complainant, in connection with the issues relating to the complaint being considered habitual or vexatious, while seeking legal advice or guidance from its solicitor or other relevant agencies.

## 2.7 Asset Management

<b>Policy Type:</b>	Administration
<b>Date Adopted:</b>	September 2016

<b>Policy No:</b>	<b>A007</b>
<b>Date Last Reviewed:</b>	25 October 2022

<b>Legal (Parent):</b>
1. Local Government Act 1995

<b>Legal (Subsidiary):</b>
1.

<b>ADOPTED POLICY</b>	
<b>Title:</b>	<b>ASSET MANAGEMENT POLICY</b>
<b>Objectives:</b>	<b>To provide clear direction in the provision and management of all Council's assets. To ensure that assets support Council's strategic vision &amp; objectives, and the delivery of sustainable services to agreed quality levels.</b>

### **POLICY**

The Shire will provide and manage assets that support the delivery of services in line with its Strategic Vision (Strategic Community Plan). Through a commitment to continuous improvement in its organisational asset management, the Shire will develop, adopt and implement a Strategy and Management Plans.

The Shire will manage its assets in a whole-of-life and economically, environmentally, culturally and socially sustainable manner. Asset management decisions will consider other key Shire policies and priority will be given to existing assets and services over new ones. Long term resource needs (Asset Management Plans) will be balanced against availability (Long Term Financial Plan).

### **SCOPE**

The Shire considers assets (such as infrastructure, land, plant and equipment) to be any that support the delivery of one or more of the following services:

- Property
- Recreation
- Transport
- Plant, Vehicles and Equipment
- Information Technology
- Waste

This Policy applies to all assets that are required to be managed by the Shire, where their components have a useful life of more than one year and a replacement cost greater than \$5,000.

### **Framework**

The Shire's Asset Management Vision shall be achieved through the implementation of an integrated planning and reporting framework that consists of:

An Asset Management Strategy that shall define the Shire's asset management Vision, Objectives, Outcomes, Enablers (e.g. Roles and Responsibilities, Training etc.), Performance Monitoring and Implementation Plan. Asset Management Plans that are driven by community informed service levels, future demand changes, long term sustainability and risk management.

Policy Updated: 23 October 2018

## 2.8 Closed Circuit Television (CCTV) Policy

<b>Policy Type:</b>	Administration
<b>Date Adopted:</b>	23 February 2021

<b>Policy No:</b>	<b>A 008</b>
<b>Date Last Reviewed:</b>	25 October 2022

<b>Legal (Parent):</b>
1.

<b>Legal (Subsidiary):</b>
1.

ADOPTED POLICY	
<b>Title:</b>	<b>CLOSED CIRCUIT TELEVISION (CCTV) POLICY</b>
<b>Objective:</b>	<b>To provide guidance for the operation of CCTV operated and controlled by the Shire of Beverley.</b>

### Objective

To provide guidance for the operation of CCTV operated and controlled by the Shire of Beverley –

- Within, on or around Shire buildings;
- Installed in public spaces; and
- Future acquisition and implementation of CCTV within the Shire.

### Scope

This policy applies to the Shire of Beverley owned, leased and operated CCTV systems only.

This policy deals with the installation and monitoring of CCTV as a strategic element of the Shire's commitment to safety and crime reduction.

### Introduction

In order to protect our assets, maintain our low rates of graffiti, vandalism, anti-social behaviour and other offences related to Statue Law, the Shire of Beverley has undertaken to use CCTV camera recording systems within the Shire of Beverley on our property and in public areas. The CCTV is to act as a deterrent and provide evidence, if required, in an attempt to reduce such acts against people and property within the Shire.

The CCTV systems may be installed anywhere throughout the Shire of Beverley within the local government boundaries.

The CCTV Surveillance System is only one of several initiatives designed to assist in preventing crimes against the person and property in Shire of Beverley. It is recognised, however, that such crime will never be totally prevented.

### Operating Procedures

#### Role and purpose of CCTV System

The Shire utilises fixed CCTV surveillance systems throughout the locality in public areas in order to:

- Deter and prevent offences against person or property.
- Protect Shire owned assets.
- Provide a record / evidence to events or incidents which may have occurred in the area of use.
- Improve the safety and amenity of residents and visitors within the Shire of Beverley.

### **CCTV staff**

- a. All staff assigned to the CCTV operations must be duly authorised by the CEO to undertake this task. Via this policy the CEO is also an authorised officer.
- b. All staff shall follow the terms and procedures of this policy when dealing with CCTV.
- c. All authorised staff shall sign the approved Code of Conduct contained in this policy.

### **Recording of Images and Still Photographs**

- a. Video images and still photographs are recorded by cameras fixed at various sites to view any identified crime within the Shire of Beverley under the control of the CEO;
- b. Downloading and storage of images or still photographs shall only occur if the Shire of Beverley CEO is of the opinion that an offence against a Statute Law has been or is being committed;
- c. At no time shall the CCTV vision or still photographs recorded be stored showing members of the public going about their lawful business;
- d. All information recorded, collected and collated by means of the CCTV system shall remain the sole property of the Shire of Beverley.
- e. Any incident recorded and stored or downloaded or still photograph taken shall be noted in the CCTV log book including date, time and category of incident;
- f. The date, time and category of incident shall be noted on the rear of any still photograph taken;
- g. All recordings and still photographs shall be kept in secure storage under the control of the Shire of Beverley;
- h. All original recordings shall be erased and still photographs shall be shredded after ninety days (90) after the date of the recording unless a request is made in writing for it to be held;
- i. All written requests for access to original recordings shall be filed within the Shires data record system;
- j. The CEO and/or authorised officer(s) may view any tape on a random basis;

### **Viewing of Images and Still Photographs**

- a. WA Police officers, lawyers acting on behalf of individuals engaged in legal proceedings related to a recorded incident or individuals acting as their own legal counsel in relation to a recorded incident may request to view a recording of that incident;
- b. Such a request must specify the date, time and location of the incident which the person wishes to view;
- c. Requests by lawyers and individuals shall be made in writing and lodged with the Shire;
- d. Requests to view a recording shall be responded to within ten (10) working days.

### **Copying of Images and Still Photographs**

- a. The CEO may authorise the copy of original recordings where a recorded incident is the subject of legal proceedings;
- b. Any recording copied is to be marked "copy" and certified as such;
- c. Certified copy of recordings may only be released to the WA Police, lawyers acting on behalf of individuals engaged in legal proceedings related to a recorded incident, or individuals acting as their own legal counsel in relation to a recorded incident;
- d. Certified copies will only be released to the parties named above when permission to do so has been received from the CEO of the Shire and on the completion of the appropriate documentation.

### **Release of Original Recordings or Still Photographs**

Original recordings and still photographs shall not be released to any person or organisation unless requested under a search warrant, court summons or by legal instrument.

### **Joint Operations with WA Police**

- a. Members of the WA Police may request the cooperation of the Shire of Beverley CCTV Surveillance systems for the purpose of covert surveillance of WA Police operations;
- b. Such requests shall be made by the WA Police officer responsible for coordinating the operation;
- c. The request shall detail the times and general purpose for which surveillance support is requested;
- d. The CEO may decline to provide cooperation;
- e. The CEO may withdraw cooperation at any time during the operation.

**Code of Practice for CCTV Surveillance System**

This policy contains a Code of Practice containing the basic standards with which the Shire of Beverley CCTV Surveillance System will be operated.

This Code of Practice is based on 14 key principles:

**Principle 1**

*The CCTV Surveillance System will be operated fairly, within applicable law, and only for the purpose for which it is established or which are subsequently agreed in accordance with this Code of Practice.*

**Principle 2**

*The CCTV Surveillance System will be operated with due regard to the privacy and civil liberties of individual members of the public, including the rights to freedom of religious and political expression and assembly.*

**Principle 3**

*The public interest in the operation of the CCTV Surveillance System will be recognised by ensuring the security and integrity of operational procedures.*

**Principle 4**

*The Shire has primary responsibilities for compliance with the purposes and objectives of the CCTV Surveillance System, for the maintenance, management and security of the program, and the protection of the interests of the public in relation to the program.*

**Principle 5**

*The Shire will be accountable to the public for the effective operation and management of the CCTV Surveillance System.*

**Principle 6**

*The public will be provided with clear and easily accessible information in relation to the operation of the Shire of Beverley CCTV Surveillance System.*

**Principle 7**

*Regular monitoring and evaluation of the CCTV Surveillance System will be undertaken to identify whether the purposes of the program are being complied with and objectives are being achieved.*

**Principle 8**

*Staff employed to operate and access CCTV Camera systems, whether they are operators, managers, or contractors will meet the highest standards probity.*

**Principle 9**

*Access to the CCTV Camera systems will be restricted to authorised officers and other authorised personnel.*

**Principle 10**

*Information recorded will be accurate, relevant and not exceed that necessary to fulfil the purposes of the CCTV Surveillance System.*

**Principle 11**

*Information will be obtained fairly and in accordance with the privacy provisions of Principal 2.*

**Principle 12**

*The retention of, and access to vision, photographs and recorded material will be only for the purposes provided by this Code of Practice. Photographs and recorded material will be retained for ninety (90) days unless they are required in relation to the investigation of crime for court proceedings.*

**Principle 13**

*Contact related to the CCTV Surveillance System between the Shire of Beverley and the W.A. Police will be conducted strictly in accordance with the Code of Practice.*

**Principle 14**

*The CCTV Surveillance System must address the interests of all who may be affected by it, and not be confined to the interests of the Shire or the needs of the Criminal Justice System.*

### **Code of Practice System Description**

The surveillance system is comprised of fixed cameras positioned to view crime hotspot areas identified in consultation with local Police. CCTV cameras record data to an associated external hard driver. All images are recorded and retained for ninety days (90) unless they are required in relation to an investigation of crime or for court proceedings.

### **Code of Practice Purpose**

#### **Principle 1**

*The CCTV Surveillance System will be operated fairly, within applicable law, and only for the purpose for which it is established or which are subsequently agreed in accordance with this Code of Practice.*

#### **Principle 2**

*The CCTV Surveillance System will be operated with due regard to the privacy and civil liberties of individual members of the public, including the rights to freedom of religious and political expression and assembly.*

#### **Principle 3**

*The public interest in the operation of the CCTV Surveillance System will be recognised by ensuring the security and integrity of operational procedures.*

The primary purpose of the Shire of Beverley CCTV Surveillance System is to assist in the identification of crimes against persons and property for example:

- Assault;
- Sexual assault;
- Graffiti
- Vandalism
- Break and enter
- Damage to property
- Anti social behaviour

The objectives of the CCTV Surveillance System are:

- i) to reduce crime levels by deterring potential offenders;
- ii) to reduce the fear of crime;
- iii) to assist in the detection and prosecution of offenders; and
- v) to help secure a safer environment for those people who live within the Shire of Beverley.

Temporary cameras may be installed for major or special events or other operational requirements.

### **Code of Practice – Responsibilities of the Shire as the Owner of the System**

#### **Principle 4**

*The Shire has primary responsibilities for compliance with the purposes and objectives of the CCTV Surveillance System, for the maintenance, management and security of the program, and the protection of the interests of the public in relation to the program.*

The Shire will be responsible for the introduction and implementation of this Code of Practice and for ensuring compliance with the principles contained within the Code.

The Shire will comply with the requirements for accountability set out in this Code of Practice.

### **Code of Practice – Accountability**

#### **Principle 5**

*The Shire will be accountable to the public for the effective operation and management of the CCTV Surveillance System.*

An audit will be conducted once a year by a CEO appointed authorised Officer, on any recorded information, log books and other documentation relating to the CCTV Surveillance System.



### **Code of Practice – Public Information**

#### **Principle 6**

*The public will be provided with clear and easily accessible information in relation to the operation of the Shire of Beverley CCTV Surveillance System.*

Advertising or notification within the local area will occur when CCTV systems commence operation and periodically throughout the year of operation to advise of the use of CCTV within the Shire, the advertising and advice will:

- i) inform the public that cameras are in operation;
- ii) inform people entering the area as to the possible operation and recording of activities in public areas; and
- iii) identify the Shire of Beverley as the owner of the system.

### **Code of Practice – Assessment of the System and Code of Practice**

#### **Principle 7**

*Regular monitoring and evaluation of the CCTV Surveillance System will be undertaken to identify whether the purposes of the program are being complied with and objectives are being achieved.*

The Shire will regularly monitor the operation of the CCTV Surveillance System and implementation of the Code of Practice. It is responsible for ensuring that the CCTV Surveillance System is regularly subject to evaluation to identify whether its purposes are being complied with and whether objectives are being achieved.

### **Code of Practice – Management of Recorded Information**

#### **Principle 8**

*Staff employed to operate and access CCTV Camera systems, whether they are operators, managers, or contractors will meet the highest standards probity.*

#### **Principle 9**

*Access to the CCTV Camera systems will be restricted to authorised officers and other authorised personnel.*

A set of Standard Operating Procedures have been developed for the operation of the CCTV system.

A Code of Conduct is incorporated into this policy and this makes plain to relevant staff that they risk disciplinary proceedings (including dismissal) if they breach any of the provisions of the Code of Practice, Protocols or Standard Operating Procedures;

### **Code of Practice – Control of Operation Cameras**

#### **Principle 10**

*Information recorded will be accurate, relevant and not exceed that necessary to fulfil the purposes of the CCTV Surveillance System.*

#### **Principle 11**

*Information will be obtained fairly and in accordance with the privacy provisions of Principal 2.*

All use of cameras will be in accord with the purposes of the CCTV Surveillance System as outlined in this Code of Practice and Standard Operating Procedures. Cameras will not be used to look into adjacent or nearby premises or buildings. Any misuse is to be treated as a breach of the Code of Practice and subject to disciplinary action.

Operators of camera equipment will act in accordance with the highest standards of probity. Only staff with responsibility for using the equipment will have access to operating controls.

### **Code of Practice – Stills and Recorded Material**

#### **Principle 12**

*The retention of, and access to vision, photographs and recorded material will be only for the purposes provided by this Code of Practice. Photographs and recorded material will be retained for ninety (90) days unless they are required in relation to the investigation of crime for court proceedings.*

Access to and use of recorded materials and photographs will only take place:

- i) in compliance with the needs of police in connection with the investigation of crime; or
- ii) if necessary for the purpose of legal proceedings.

Recorded material and photographs will not be sold or used for commercial purposes or the provision of entertainment.

The showing of recorded material or photographs to the public will be allowed only in accordance with the needs of the police in connection with the investigation of crime or in any other circumstances provided by law. The CEO must formally approve any such action.

Use of recorded material or photographs by the media should only occur to gain public information with respect to the identity of a person/s wanted in connection with a criminal investigation. Subject to the agreement of the Police, the CEO may approve such releases. In such cases the recognisable characteristics of other people in the footage shall be obscured.

Images from recordings shall not, under any circumstances, be used to publicise the existence of Shire of Beverley CCTV Surveillance System.

Appropriate security measures will be taken against unauthorised access to, alteration, disclosure, accidental loss or destruction of recorded material.

#### **Code of Practice – Contact with Police**

##### ***Principle 13***

*Contact related to the CCTV Surveillance System between the Shire of Beverley and the W.A. Police will be conducted strictly in accordance with the Code of Practice.*

Police officers will not be permitted to remove any recorded material or photograph, operate video equipment or have contact with recorded material or photographs at any time unless under the terms of this Code of Practice, the Protocols or Standard Operating Procedures or subject to the execution of a search warrant or other relevant legal process.

Any involvement in the CCTV Surveillance System by W.A. Police will be recorded by the Shire of Beverley and will be subject to audit.

#### **Code of Practice – Breaches of the Code**

##### ***Principle 14***

*The CCTV Surveillance System must address the interests of all who may be affected by it, and not be confined to the interests of the Shire or the needs of the Criminal Justice System.*

Prime responsibility for ensuring the Code of Practice is adhered to rests with the Shire. This responsibility includes ensuring that breaches of the Code are investigated and remedied to the extent that breaches of the Code are within the Shire power to remedy.

**Code of Conduct – Authorised Officers**

*This Code of Conduct has been developed to ensure that the highest ethical standards are Practiced by Authorised Officers who operate the Shire of Beverley closed circuit television monitoring equipment (CCTV).*

**BEHAVIOUR OF AUTHORISED OFFICERS:**

The Shire of Beverley expects its Authorised Officers to:

- Treat all people captured on camera with the same dignity as if they were having face to face contact with the person.
- At all times act in an honest and legal manner and carry out duties in a manner that reflects community values.
- Interact with fellow workers and Police in a timely, courteous and cooperative manner.

If doubt arises as to the appropriateness of a working behaviour, first consider whether the action is legal and then consider how the behaviour would appear if it was reported in the newspapers.

**CONFIDENTIALITY**

The Shire of Beverley expects Authorised Officers to ensure confidentiality of information gathered by surveillance or learnt from CCTV operations, by not discussing any events with fellow workers who have no direct responsibility for the matter. In addition, officers will not discuss events with family, friends, or acquaintances. All the above applies during and after termination of employment.

**ETHICAL USE OF RECORDING EQUIPMENT AND RECORDED MATERIAL**

- In the course of carrying out duties, cameras must not be used for personal benefit to invade individual or group privacy. Cameras must only be used where there is a belief that an offence has or is likely to occur.
- Material shall not be copied or removed from the Shire of Beverley recording facility without formal authorisation of the Chief Executive Manager.
- Business records (hard copy or photographic) can only be destroyed with authorisation and in accordance with approved Council policies and government regulations.
- Tapes and photographs shall only be released to the police when requested in writing in the correct format and the appropriate authorisation having been granted.

**REPORTING AN INAPPROPRIATE WORK BEHAVIOUR**

If the occasion occurs that an officer witnesses or becomes aware of an officer of the Shire of Beverley work behaviour is or was inappropriate, and the incident has not been dealt with through normal supervisory procedures, then the officer is obliged to report the incident to his/her Executive Manager. In return, the Executive Manager will guarantee that any reported matters will be handled with sensitivity and without repercussion.

**NON COMPLIANCE WITH CODE OF CONDUCT**

The Shire of Beverley takes pride in the high standards of integrity and honesty it expects and receives from its staff. As a consequence, if the occasion arises where it has been found that an officer has not complied with this Code of Conduct, the Shire of Beverley may take disciplinary action which may result in dismissal.

**I have read and understood the above Code of Conduct and agree to abide by these conditions.**

**SIGNATURE:**.....

**DATE:**.....

**REQUEST FORM TO BE COMPLETED BY POLICE FOR USE OF  
SURVEILLANCE RECORDS**

To: Chief Executive Officer

It is requested that a hard drive/thumb drive (device provided by Police) copy or photograph showing an Incident which is the subject of Police inquires on (date and approximate time) \_\_\_\_\_ be released to me for the purpose of Evidence/Investigations.

I accept full responsibility for this hard drive/thumb drive copy / photograph whilst it is in my possession and understand that I am **NOT** at liberty to make or release copies of the footage or permit other persons to make copies or lend it to persons outside the Police Service.

The hard drive/thumb drive copy / photograph will **NOT** be released to the Media under any circumstances unless authorised by the CEO of the Shire of Beverley.

**POLICE**

SIGNED: \_\_\_\_\_

NAME: \_\_\_\_\_

RANK & NO: \_\_\_\_\_

STATION/SECTION: \_\_\_\_\_

DATE: \_\_\_\_\_

**SHIRE of BEVERLEY**

CEO or Authorised Officer Only

SIGNED: \_\_\_\_\_

NAME: \_\_\_\_\_

DATE: \_\_\_\_\_

## 2.9 Information and Communications Technology (ICT) Usage

<b>Policy Type:</b>	Administration
<b>Date Adopted:</b>	24 May 2022

<b>Policy No:</b>	<b>A009</b>
<b>Date Last Reviewed:</b>	25 October 2022

<b>Legal (Parent):</b>
1.

<b>Legal (Subsidiary):</b>
1.

ADOPTED POLICY	
<b>Title:</b>	<b>INFORMATION AND COMMUNICATIONS TECHNOLOGY (ICT) USAGE POLICY</b>
<b>Objective:</b>	<b>To establish guidelines on the appropriate usage of the Shire's information and communication technology (ICT) systems and devices to ensure the ongoing security and integrity of the Shire's network system.</b>

### Objective

To establish guidelines on the appropriate usage of the Shire's information and communication technology (ITC) systems and devices to ensure the ongoing security and integrity of the Shire's network system.

### Policy Statement

Effective security is a team effort involving the participation and support of every Shire of Beverley employee who deals with information and/or information and communication systems and devices. Every digital device user must understand this policy and carry out their use of digital devices in accordance with this policy. For the purposes of this policy the term employee/s shall cover staff, councillors, volunteers and any person performing work on a permanent basis with the Shire of Beverley.

### General Use of ICT Equipment

1. Users should be aware that the data they create on the corporate systems remain the property of the Shire of Beverley. The confidentiality of personal (non-work related) information stored on any network device belonging to the Shire of Beverley cannot be guaranteed.
2. A degree of personal use is allowed on the Shire's equipment/devices/systems. Employees should exercise conservative judgment regarding the reasonableness of personal use but should be guided by the following principles:
  - personal use should be conducted either before or after contracted hours of work or during authorised breaks;
  - personal use should be limited and brief, avoiding excessive downloads or transmissions. An example of acceptable personal use would be conducting brief transactions through internet banking;
  - personal use should not breach anything in this policy, particularly relating to the downloading of offensive or copyrighted materials;
  - managers will determine the specific acceptable personal use for their respective business areas as this will differ according to the needs of each group; and
  - if there is any uncertainty regarding acceptable personal use then employees should consult their supervisor or manager for guidance.
3. For security and network maintenance purposes, authorised individuals within the Shire of Beverley may monitor equipment, systems and network traffic at any time, according to the specific nature and requirements of their roles.

4. The Shire of Beverley reserves the right to audit networks and systems on a periodic basis to ensure system integrity and compliance with this policy.

All emails sent by Shire of Beverley employees should include the approved signature and disclaimer at the foot of the body of the email, in the format specified by the Shire of Beverley style guide.

### **Security and Proprietary Information**

1. All information stored in the Shire of Beverley's corporate systems should be regarded as confidential and care must be exercised before sharing or distributing any information. If there is any uncertainty regarding the level of confidentiality involved then employees should consult their supervisor or manager for guidance.
2. Passwords should be kept secure and accounts must not be shared. Authorised users are responsible for the security of their passwords and accounts. Passwords should be changed in accordance with advice from the Shire of Beverley ICT Consultants.
3. All devices connected to the Shire of computing systems/networks, regardless of ownership, must be running approved and up to date virus-scanning software.
4. Employees must use caution when opening files received from unknown senders.

### **Acceptable Use**

The information in this policy provides a framework for activities which fall into the category of unacceptable use, but do not represent an exhaustive list. Some users are exempted from these restrictions during the course of carrying out responsibilities related to their role.

Under no circumstances is any user authorised to engage in any activity that is illegal under local, state, federal or international law while connected to or utilising Shire of Beverley ICT systems or resources.

### **System and Network Activities**

*The following activities are not permitted:*

- Violations of the rights of any person or company/organisation protected by copyright, trade secret, patent or other intellectual property, or similar laws or regulations, including, but not limited to, the duplication, installation or distribution of pirated or other software products that are not appropriately licensed for use by the Shire of Beverley or the end user.
- Unauthorised copying or digitising of copyrighted material and the installation of any copyrighted software for which the Shire of Beverley or the end user does not have an active license.
- Exporting software, technical information, encryption software or technology, in violation of international or regional export control laws. The appropriate manager should be consulted prior to export of any material where status is unclear.
- Introduction of malicious programs or codes into the network or onto devices connected to the network.
- Revealing your account password to others or allowing use of your account by others.
- Using Shire of Beverley equipment for the downloading or distribution of any material that could be considered as offensive. If an employee receives such material they should notify their manager and also the ICT Team.
- Making fraudulent offers of products, items, or services, or running private business interests via any Shire of Beverley equipment, device or account.
- Undertaking Private Work

*The following activities are not permitted unless they are within the scope of regular responsibilities for an expressly authorised role/position:*

- Effecting security breaches or disruptions of network communication. Security breaches include, but are not limited to, accessing data of which the user is not an intended recipient or logging into a server or account that the user is not expressly authorised to access.
- Executing any form of network monitoring which will intercept data not intended for the user's host.
- Attempting to avoid or bypass the Shire of Beverley's network security measures.

- Interfering with any others users account, by whatever means.
- Using the system in a way that could damage or affect the performance of the network in any way.

#### **Email and Communications Activities**

The following activities are not permitted:

- Except in the course of normal business notifications, sending or forwarding unsolicited electronic messages, including the sending of junk mail or other advertising material, jokes, or chain communication to individuals who did not specifically request such material.
- Any form of harassment via electronic/ICT means.
- Unauthorised use, or forging, of email header information.
- Solicitation of communication for any other electronic address, other than that of the poster's account, with the intent to harass or to collect replies.
- Creating or forwarding chain letters, pyramid schemes, or any manner of financial information aimed to entice subscription, of any type.
- Use of any of the Shire of Beverley network or systems for the purpose of generating unsolicited communications.
- Providing information about, or lists of, the Shire of Beverley employees to parties outside the Shire of Beverley or to personal email addresses.
- Communicating in a manner that could adversely affect the reputation or public image of the Shire of Beverley.
- Communicating in a manner that could be construed as making statements or permission to do so.

Users should also endeavour to archive their Inbox, Sent Items, Deleted Items and other email boxes on a regular basis, by either archiving or saving in the central record system. A size limit per mailbox may be implemented to ensure that the system is functioning optimally.

#### **Remote Access**

Employees with remote access are subject to the same rules and regulations that apply to the Shire of Beverley corporate equipment and systems. That is, their network and servers to ensure the security and integrity of data and records.

Employees are reminded of the following conditions relating to remote access to the Shire of Beverley system:

- Family members must not violate any of the Shire of Beverley policies, perform illegal activities, or use the access for outside business interests.
- The device that is connected should be secure from access by external non-Shire of Beverley parties and should be under the complete control of the user.
- The use of non-Shire of Beverley email accounts (e.g. Hotmail, Gmail, Bigpond etc.) or other external resources is not permitted for the conduct of Shire of Beverley business, thereby ensuring official business is not confused with personal business.
- All devices (whether personal or corporate) connected to the Shire of networks via remote access technologies should have up-to-date anti-malicious-code software.

#### **Provision and Use of Mobile Phones and Information/ Communication Devices**

Some employees will be supplied with a mobile phone and/or other mobile computing device if it is deemed necessary to their position. All mobile/portable devices supplied remain the property of the Shire of Beverley and users must not change service providers unless authorized in writing to do so.

Where a mobile phone or device provides an email service, all emails sent or received or otherwise processed via the mobile device that are classified as a record of the Shire of Beverley should be sent through the Shire of Beverley server, to ensure the integrity of the recordkeeping system.

Where the device includes a digital camera, users are to use the technology in a sensible manner. A failure to do so may lead to disciplinary action including possible termination of employment. Employees may also be held criminally liable for their actions.

It is unlawful for drivers to operate a mobile phone and/or other mobile computing device whilst driving. Phone calls may otherwise be made or received providing the device is accessible while mounted/fixed to the vehicle or does not need to be touched by the user. An employee who operates a mobile phone and/or other mobile computing device whilst driving may face disciplinary action including possible termination of employment. Employees may also be held criminally liable for their actions.

The following conditions apply to the provision and use of mobile phones and other electronic devices:

- The allocation of mobile phones and other devices for business purposes shall be determined by the CEO and the Deputy CEO based on operational need.
- The purchase and replacement of mobile phones and other devices shall be determined by the CEO and DCEO.
- All staff in receipt of a mobile phone and other device shall sign an acceptance form acknowledging the provisions of this policy.
- A Shire mobile phone is to be used for business use except in the event of a personal emergency, unless otherwise approved by CEO or documented as a benefit in an Employee's Employment Package.
- Should an employee's private use and/or other device be determined by the CEO to unreasonable and excessive, such costs attributed to that use shall be reimbursed by the employee.
- A Councillor or employee in possession of a mobile telephone and/or other device is responsible for its use and care, and shall provide immediate notification of any loss, damage or malfunction, with explanation to the particular circumstances.
- The Shire may withdraw entitlement to use a mobile phone or other device should there be evidence or an admission as to personal neglect or abuse. Reimbursement of the cost for repair, replacement, or reimbursement of excessive use may be sought from the offending officer at the discretion of the CEO.
- Staff may be required to return mobile phones and/or devices to the office or other staff members during period of leave.
- The CEO may award a Mobile Phone Allowance to certain staff to allow them to carry and use their personal mobile phone for calls / texts for work purposes as and when the need arises.
- Where a mobile phone or device is willingly or maliciously damaged or lost, the person to which the mobile phone or device is responsible shall repair or replace the mobile phone or device at their cost.

#### **Consequences of Breaching This Policy**

Any employee found to have breached this policy may be subject to disciplinary action including possible termination of employment. The Shire of Beverley may also be obligated to refer any breach of this policy to an external agency where an employee may be held criminally liable for their actions.

Private/personal or unauthorised use of corporate ICT systems and/or devices may result in the employee being obligated to pay any extra costs incurred.



**SHIRE OF BEVERLEY  
INFORMATION AND COMMUNICATIONS TECHNOLOGY USAGE AGREEMENT**

I, \_\_\_\_\_ acknowledge that I have read the Information and Communications Technology Usage Policy and accept the guidelines relating to all devices and networks contained in the policy which ensure the ongoing security and integrity of the Shire of Beverley's network system.

\_\_\_\_\_  
Name

\_\_\_\_\_  
Position

\_\_\_\_\_  
Signature

\_\_\_\_\_  
Date

**Witness**

\_\_\_\_\_  
Name

\_\_\_\_\_  
Position

\_\_\_\_\_  
Signature

\_\_\_\_\_  
Date

### 3. *Community*

#### 3.1 Community Use of Town Hall Meeting Room

<b>Policy Type:</b>	Community
<b>Date Adopted:</b>	September 2014

<b>Policy No:</b>	<b>C001</b>
<b>Date Last Reviewed:</b>	25 October 2022

<b>Legal (Parent):</b>	1.
------------------------	----

<b>Legal (Subsidiary):</b>	1.
----------------------------	----

<b>ADOPTED POLICY</b>	
<b>Title:</b>	<b>COMMUNITY USE OF TOWN HALL MEETING ROOM</b>
<b>Objective:</b>	<b>To provide a place for local community groups to meet and share information.</b>

#### Policy

Local Community groups may use the Town Hall Meeting Room at no cost.

Groups wishing to use the meeting room are to book in advance.

Policy Amended: 25 October 2016



### 3.2 Hiring of Furniture and Other Equipment

<b>Policy Type:</b>	Community
<b>Date Adopted:</b>	September 2014

<b>Policy No:</b>	<b>C002</b>
<b>Date Last Reviewed:</b>	25 October 2022

<b>Legal (Parent):</b>
1.

<b>Legal (Subsidiary):</b>
1.

<b>ADOPTED POLICY</b>	
<b>Title:</b>	<b>HIRING OF FURNITURE AND OTHER EQUIPMENT</b>
<b>Objective:</b>	<b>To advise the community and staff of building hire rules.</b>

#### Policy

Where a Shire of Beverley managed building has been hired, the hire includes the use of furniture, fittings or effects, crockery, cutlery, glassware etc normally located in the building. Such items are not to be removed from the premises except when permitted in writing by Chief Executive Officer.

Chair hire as per the Fees and Charges schedule is expressly the old green chairs, formerly used at the Amenities Building and now stored in the Exhibition Shed. Chairs may not be hired from the Hall or Amenities Building.

### 3.3 Deposits for Hiring Buildings

<b>Policy Type:</b>	Community
<b>Date Adopted:</b>	September 2014

<b>Policy No:</b>	<b>C003</b>
<b>Date Last Reviewed:</b>	25 October 2022

<b>Legal (Parent):</b>
1.

<b>Legal (Subsidiary):</b>
1.

<b>ADOPTED POLICY</b>	
<b>Title:</b>	<b>DEPOSITS FOR HIRING BUILDINGS</b>
<b>Objective:</b>	<b>To establish a safeguard for the hire of Shire owned buildings.</b>

#### Policy

The hiring of any Shire of Beverley managed facility is conditional upon a key bond and cleaning bond being paid to safeguard against the cost of repairs of any damage caused to the building or its contents, including crockery. The bond shall also cover any major cleaning by the Maintenance Officer, above normal duties, after the function.

1. All costs of major cleaning and repairs are to be deducted from bond monies. Any costs over and above the amount of the bond are to be recovered from the persons or group having hired the facility.
2. The bond is not to be returned until the key is returned and the premises have been checked for damage by Staff.

### 3.4 Liquor on Shire of Beverley Property

<b>Policy Type:</b>	Community
<b>Date Adopted:</b>	September 2014

<b>Policy No:</b>	<b>C004</b>
<b>Date Last Reviewed:</b>	25 October 2022

<b>Legal (Parent):</b>
1.

<b>Legal (Subsidiary):</b>
1.

<b>ADOPTED POLICY</b>	
<b>Title:</b>	<b>LIQUOR ON SHIRE OF BEVERLEY PROPERTY</b>
<b>Objective:</b>	<b>To establish liquor control in Shire owned property.</b>

#### Policy

No liquor of any type shall be permitted to be stored or consumed on Shire of Beverley controlled public property without the consent of the Chief Executive Officer.

1. Clubs may apply for seasonal consent to consume liquor with all dates to be shown on the letter of consent. Groups and individuals may apply for one-off consent for events.
2. If liquor is to be sold, a liquor permit from the relevant authority must be obtained.

### 3.5 Public Buildings – Time Limits

<b>Policy Type:</b>	Community
<b>Date Adopted:</b>	September 2014

<b>Policy No:</b>	<b>C005</b>
<b>Date Last Reviewed:</b>	25 October 2022

<b>Legal (Parent):</b>
1.

<b>Legal (Subsidiary):</b>
1.

<b>ADOPTED POLICY</b>	
<b>Title:</b>	<b>PUBLIC BUILDINGS – TIME LIMITS</b>
<b>Objective:</b>	<b>To establish a closing time for hired buildings owned by the Shire of Beverley.</b>

#### Policy

The maximum time for which all Shire of Beverley hired buildings are allowed to remain open and in use is 2:00am.

Noise should be at a very minimum from midnight – 2:00am.

All lights are to be turned off and all doors and windows closed and locked by 2:00am.

### 3.6 Swimming Pool Season

<b>Policy Type:</b>	Community
<b>Date Adopted:</b>	September 2014

<b>Policy No:</b>	<b>C006</b>
<b>Date Last Reviewed:</b>	25 October 2022

<b>Legal (Parent):</b>
1.

<b>Legal (Subsidiary):</b>
1.

ADOPTED POLICY	
<b>Title:</b>	<b>SWIMMING POOL SEASON</b>
<b>Objective:</b>	<b>To establish the yearly swimming season.</b>

#### Policy

Having regard to prevailing weather conditions, the season will normally commence on 1 November each year and close on the 31 March the following year.



### 3.7 Swimming Pool – Supervision

<b>Policy Type:</b>	Community
<b>Date Adopted:</b>	September 2014

<b>Policy No:</b>	<b>C007</b>
<b>Date Last Reviewed:</b>	25 October 2022

<b>Legal (Parent):</b>
1.

<b>Legal (Subsidiary):</b>
1.

ADOPTED POLICY	
<b>Title:</b>	<b>SWIMMING POOL SUPERVISION</b>
<b>Objective:</b>	<b>To ensure the safety of Children patronising the Swimming Pool.</b>

#### Policy

No child under 10 years of age is allowed into the Swimming Pool unless accompanied by a person aged 18 years or older.

The Swimming Pool Manager is to enforce this Policy.

### 3.8 Community Bus

<b>Policy Type:</b>	Community
<b>Date Adopted:</b>	September 2014

<b>Policy No:</b>	<b>C008</b>
<b>Date Last Reviewed:</b>	25 October 2022

<b>Legal (Parent):</b>
1.

<b>Legal (Subsidiary):</b>
1.

ADOPTED POLICY	
<b>Title:</b>	<b>COMMUNITY BUS</b>
<b>Objective:</b>	<b>To establish guidelines for the Hire of the Community Bus.</b>

#### Policy

The Community Bus is available for hire according to the current Fees Schedule. The driver is to hold a current LR class licence. The kilometres, drivers details and any mechanical faults are to be recorded. All passengers are to wear their seatbelts.

Policy Amended: 25 October 2022

### 3.9 Flag Poles

<b>Policy Type:</b>	Community
<b>Date Adopted:</b>	September 2014

<b>Policy No:</b>	<b>C009</b>
<b>Date Last Reviewed:</b>	25 October 2022

<b>Legal (Parent):</b>
1.

<b>Legal (Subsidiary):</b>
1.

ADOPTED POLICY	
<b>Title:</b>	<b>FLAG POLES</b>
<b>Objective:</b>	<b>To establish guidelines for the flying of flags.</b>

#### Policy

The single flag pole outside the Shire of Beverley Office is dedicated to flying a local Shire Flag Monday – Friday during office hours. The single flag pole at the Shire Office will have the Be Very You logo Flag flown (even if the Town Hall flag is at half-mast).

The three grouped flag poles will fly the Australian Flag, the Western Australian State Flag and the Aboriginal Flag. These three flags will follow all protocol as directed by the Department of Prime Minister and Cabinet.

The Shire of Beverley will fly the Shire Flag at Half Mast on the Town Hall to recognise residents and former residents of Beverley who have passed away. The flag will fly continually from time of notification to the time of burial, cremation or memorial when it will be taken down. The notification must come from a family member of the deceased.

Amended: 25 February 2020

### 3.10 Caravan Park – Maximum Stay

<b>Policy Type:</b>	Community
<b>Date Adopted:</b>	September 2014

<b>Policy No:</b>	<b>C010</b>
<b>Date Last Reviewed:</b>	25 October 2022

<b>Legal (Parent):</b>
1.

<b>Legal (Subsidiary):</b>
1.

ADOPTED POLICY	
<b>Title:</b>	<b>MAXIMUM STAY IN CARAVAN PARK</b>
<b>Objective:</b>	<b>To establish guidelines for staying in the Caravan Park.</b>

#### Policy

The Beverley Caravan Park is dedicated for visitors and tourists and does not accept long term rentals.

The maximum permitted stay in the Beverley Caravan Park is 28 days. Any stay longer than 28 days is to seek permission in writing from the Chief Executive Officer. The Chief Executive Officer has the authority to accept or reject a stay longer than 28 days up to a maximum of 3 months.

Policy Amended: 23 October 2018

### 3.11 Caravan Park – Dogs

<b>Policy Type:</b>	Community
<b>Date Adopted:</b>	September 2014

<b>Policy No:</b>	<b>C011</b>
<b>Date Last Reviewed:</b>	25 October 2022

<b>Legal (Parent):</b>
1.

<b>Legal (Subsidiary):</b>
1.

<b>ADOPTED POLICY</b>	
<b>Title:</b>	<b>DOGS IN THE CARAVAN PARK</b>
<b>Objective:</b>	<b>To establish guidelines for persons staying with dogs in the Caravan Park.</b>

#### Policy

Dogs are permitted in the Caravan Park if kept in a caravan or on a leash at all times. If a dog kept in the caravan park becomes a problem through excessive noise, lack of hygiene or misbehaviour, the owners and dog can be asked to leave.

### 3.12 Community Grants

<b>Policy Type:</b>	Community
<b>Date Adopted:</b>	September 2014

<b>Policy No:</b>	<b>C012</b>
<b>Date Last Reviewed:</b>	25 October 2022

<b>Legal (Parent):</b>	1.
------------------------	----

<b>Legal (Subsidiary):</b>	1.
----------------------------	----

ADOPTED POLICY	
<b>Title:</b>	<b>COMMUNITY GRANTS</b>
<b>Objective:</b>	<b>To provide positive financial support for Not For Profit Community Groups</b>

#### **Objective**

To provide positive financial support to Incorporated, Not for Profit Beverley focussed community organisations that will assist with the development of their chosen interest and that meets the application criteria (subject to budget constraints) and promotes the Shire of Beverley as a positive, supportive and caring community organisation.

#### **Policy**

The Shire of Beverley will make an allocation of funds in its budget to be used to provide financial assistance to Incorporated, Not for Profit Community Organisations that can demonstrate an association with the Shire of Beverley. Funding for Incorporated, Not for Profit Community Organisations will be made bi-annually. Calls for submissions will be advertised in the Beverley Blarney.

An allowance for these funds will be included in the Shire of Beverley Annual Budget funded from the Cropping Committee Reserve (as balance of Reserve funds allow).

Examples of Not for Profit organisations are:-

Sporting Clubs, CWA, P & C, Arts and Cultural Groups or other Shire of Beverley local interest groups.

Funding to Community Organisations fall into two categories:-

#### **1. Minor Community Grants**

Funding of less than \$1,000 with no matching funds required from the applicant.

Projects must seek to further the development of one of the following:

- early years (0 to 4 years);
- environment;
- history and or heritage;
- seniors;
- tourism;
- volunteer upskilling;
- sport and recreation
- youth (5 to 18 years).

## **2. Community Grants**

Funding between \$1,000 - \$5,000 with a 50:50 matching component where applicants must contribute at least 50% of total project cost from either the applicant organisation or confirmed other funding sources. Evidence of other funding sources must be provided.

### **Assessment**

Organisations registered for GST will have their grant grossed up by 10%

Applications need to demonstrate the benefits to the community or individual.

Applications for Minor and Community Grants will be assessed and referred to Council for a final determination.

Preference will be given to projects with demonstrated community support.

All applicants will be notified in writing of the outcome of their application for Shire of Beverley assistance.

Decisions regarding funding applications are final and will not be reconsidered.

### **Funding will not be provided for: -**

Uniforms

Consumables (including food and beverages, stationery and other office supplies)

Awards and prizes

Minor equipment (footballs, netballs, hockey sticks etc. Junior Sporting Clubs are exempt)

Recurrent salaries and recurrent operational costs

Completed projects or equipment already purchased

Projects that are the responsibility of other Government Agencies.

Deficit funding for organisations that are experiencing a shortfall in cash or revenue or anticipated revenue.

### **Application Criteria**

All applicant organisations must be based within the Shire of Beverley, with a majority of members of the applicant organisation preferably being residents of the Shire of Beverley.

All applications for financial assistance must be submitted on the Shire of Beverley "Application for Financial Assistance" form.

The applicant should submit documented estimates of expenditure as part of the application ie quotes or written estimates.

All applications must be received by the designated closure date. No late applications will be considered.

For Community Grants the applicants and other contributions to the proposed project may come from one or more of the following sources:-

- Applicant organisations cash;
- State or Federal Government funding agencies;
- Donations of material and /or cash;
- Voluntary labour (max 1/3 of total contribution cost)
- Voluntary labour cost to be calculated at a maximum of \$25 per hour.

Only one (1) application per financial year for financial assistance from a Community Grant will be considered per organisation.

Community organisations may apply for Minor Grants in each of the funding rounds, however, each grant must be for a separate project. (Where an organisation applies for more than one Minor Grant they must prioritise their applications).

Prior approval in writing must be sought for any substantial change to the assistance request.

The Community Organisation must provide a tax invoice to the Shire of Beverley before \_\_\_\_\_.

### **Acquittal**

Projects must be completed by \_\_\_\_\_. Project and financial reports must be submitted to the Shire of Beverley, in "Section F Grant Acquittal" of the application, by \_\_\_\_\_.

Organisations with outstanding acquittals will not be eligible to apply for the next funding round.

Once an allocated budget has been utilised all subsequent requests for funding must be presented to Council for consideration.

### **UNDERTAKINGS AND CONDITIONS**

If a grant is provided the organisation agrees to the following conditions:

1. The grant will be used for the purpose which it was given and will be expended within the financial year granted, unless otherwise agreed in writing by the Shire of Beverley.
2. If successful in your application, your organisation is required to provide the Shire of Beverley with a tax invoice before the \_\_\_\_\_ for the amount of allocated funds.
3. The acquittal must be returned to the Shire of Beverley within one month of completion of your project or by \_\_\_\_\_. Copies of project receipts must be attached
4. The Shire of Beverley will issue an invoice to the organisation for an amount equal to any unexpended funds.
5. If there is to be any delay in the expenditure of the grant, a written request will be made to the Shire of Beverley seeking approval for an extension of time.
6. A grant will not be approved for a project that has commenced or been completed.
7. Any special conditions that are attached to the grant will be met.
8. All relevant records will be kept for a period of 7 years and will be made available for audit at any time.
9. The Shire of Beverley will be acknowledged in any publications or media coverage for its support.
10. Your project should be discussed with a Shire of Beverley representative prior to applying.
11. Keep a copy of your application for your own record.
  - A Shire Officer will contact you if more information is required.
  - All applicants are advised in writing of the outcome.
  - Applications are processed in the order in which they are received.
  - Assessment will take a minimum of one month.

Please refer to the Shire Office for the Application Package, which can slightly alter each grant period.

Policy Amended: 23 October 2018  
Policy Amended: 23 November 2021



### 3.13 Community Use of the Digital Signage Trailers

<b>Policy Type:</b>	Community
<b>Date Adopted:</b>	December 2016

<b>Policy No:</b>	<b>C013</b>
<b>Date Last Reviewed:</b>	25 October 2022

<b>Legal (Parent):</b>
1.

<b>Legal (Subsidiary):</b>
1.

<b>ADOPTED POLICY</b>	
<b>Title:</b>	<b>COMMUNITY USE OF THE DIGITAL SIGNAGE TRAILERS</b>
<b>Objective:</b>	<b>To provide free advertising for local, not for profit groups running community events</b>

#### Policy

The Shire of Beverley may allow not for profit community groups to advertise on the Digital Signage Trailers providing they are running a community event which will provide significant benefit to Beverley.

Community groups may advertise their events, free of charge, on the digital signage boards; under the following conditions:

- The Shire has priority use, for example road works.
- The Shire decides on the location of the trailers.
- The trailers must be booked, through the Shire booking system, a minimum of one week in advance.
- The advertisement can run for a maximum of 14 days, and
- be no more than 3 slides long.
- The advertisement will benefit the community

Wording will be limited due to the size of the screen, and be subject to change at the discretion of the Shire.

Policy Amended: 23 October 2018

### 3.14 Brand Usage ‘Beverley – Be very you’

<b>Policy Type:</b>	Community
<b>Date Adopted:</b>	May 2017

<b>Policy No:</b>	<b>C014</b>
<b>Date Last Reviewed:</b>	25 October 2022

<b>Legal (Parent):</b>
1.

<b>Legal (Subsidiary):</b>
1.

ADOPTED POLICY	
<b>Title:</b>	<b>BRAND USAGE ‘BEVERLEY – BE VERY YOU’</b>
<b>Objective:</b>	<b>A guide to assist in the correct usage of the Beverley – Be very you logo</b>

#### Policy

#### **Logo Usage Guidelines**

You are permitted to use the *Beverley – Be very you* logo (logo) for display on any printed material, websites, social media accounts, and promotional material, provided it complies with the Terms and Conditions and meets the logo usage guidelines outlined below.

You are welcome to use the logo on any printed material or online forum that promotes your business, group, event, or the town of Beverley, in a positive way. The phrase can be used as is or altered slightly in a way that suits your business provided the words ‘Be very’ are maintained. The word ‘you’ can be replaced, on the condition it complies with the Terms and Conditions, is not offensive, and does not promote any unruly or unethical behaviour. A few examples of how you can use this text are provided.

#### **Logo Display**

The logo must stand alone. A minimum amount of space must be visible between the logo and other text, graphics or photos. The minimum space is defined as the approximate size of the ‘e’ in Beverley. The logo must not be positioned on top of a photo unless the background is clear (i.e. a solid, light colour, or white).

#### **Logo Colour**

The logo should always be used in full colour when displayed on websites or on social media. The logo should be used in full colour for printed material unless a colour version is not practical and then it can be used in black, or white, depending on which is most visually pleasing on the specific document.

The preferred background is white. When this is not possible it may be used on a solid, light colour background. If the background must be black or a dark colour, the white logo can be used. The background must be a solid colour.

#### **Logo Size**

The logo must be at least 10mm high (*will be determined when artwork is finalized*) on any printed material. The logo must retain original proportions and not be resized in any way that would cause distortion or degradation to the quality of the logo. On any online forum the logo must be big enough to clearly read the phrase ‘Be very you’.

**Terms and Conditions**

The logo may not be displayed on any material, printed or online, that could be considered offensive, or defamatory to any person, people, group, or organisation.

The logo may not be displayed on any material to promote any illegal activities, including but not limited to the sale of alcohol to minors.

The logo may not be displayed on any material to promote an event for any specific political party, lobby group, or advocacy group.

Stakeholders must adhere to the usage recommendations.

Failure to comply with these terms will result in immediate revoking of permission to use the logo.

The Shire of Beverley reserves the right to refuse or revoke permission to use the logo.

If you need clarification on any of these terms and conditions please speak with the Tourism Project Officer at the Shire of Beverley.

**Contract for use**

I, \_\_\_\_\_, representing (business, group, organisation), \_\_\_\_\_  
\_\_\_\_\_, agree to the Terms and Conditions listed above and understand failure to comply will result in a revoking of permission to use the logo.

Signed: \_\_\_\_\_

Date: \_\_\_\_\_

**Examples of 'Be very you' alternatives**

The examples provided below are just some of the ways you can incorporate the *Be very you* message into your promotion. Please be aware of the alternate connotation each individual phrase has whether and not it could be construed to cause offence to any person or group.

- Café/bakery    Be very **satisfied**  
                  Be very **chatty**  
                  Be very **happy**
- Pub/hotel      Be very **merry**  
                  Be very **bubbly**
- Tennis          Be very **bouncy**
- Photography   Be very **clicky**  
                  Be very **focused**
- Walks/hiking   Be very **muddy**  
                  Be very **fresh**
- BnBs            Be very **at home**  
                  Be very **comfortable**

### 3.15 Cornerstone Digital Display

<b>Policy Type:</b>	Community
<b>Date Adopted:</b>	18 December 2018

<b>Policy No:</b>	<b>C015</b>
<b>Date Last Reviewed:</b>	25 October 2022

<b>Legal (Parent):</b>
1.

<b>Legal (Subsidiary):</b>
1.

<b>ADOPTED POLICY</b>	
<b>Title:</b>	<b>USE OF THE CORNERSTONE DIGITAL DISPLAY</b>
<b>Objective:</b>	<b>To provide guidance regarding the utilisation of the Cornerstone Digital Display facing Vincent Street.</b>

#### Policy

The intended use of the Cornerstone Digital Display is that it be used as a communication tool to inform visitors and residents of relevant local information and details of local events.

Only information relevant to the Beverley district is to be displayed on the Cornerstone Digital Display.

Information allowable to be displayed is as follows:

- The date and time;
- Local temperature;
- Shire Of Beverley Information Notices;
- Community Resource Centre Information Notices;
- Total Fire Ban/Harvest Ban Alerts;
- Holiday wishes limited to Easter and Christmas; and
- Information regarding Community Not For Profit Events.

Further, advertising on the Cornerstone Digital Display is allowable pursuant to the following conditions:

- The Advertising is of a local business; or
- The Advertising for a local profit generating Event; and
- A fee of \$50 ex GST for set up and maintenance and \$50 ex GST per calendar month (paid in advance) to display is paid.

Community information and paid advertising display will run on a continuous loop between 6.00am and 8.00pm, being the operating period (total 14 hours).

A display will run for 10 seconds.

A loop will be for a maximum of 4 minutes or 24 10 second displays per screen.

The minimum exposure per display over the operating time will be 210 times shown during the operating period.

No alteration or discount will be applied to the fee chargeable for paid advertising in the event of reduced exposure from short term (less than 24 hour) power outages or equipment failure.

For outages lasting longer than 24 hours a pro rata refund will be applied to each additional outage hour over 24 hours based on a 28 day month (392 operating hours).

Refund calculation =  $\$50/392 = \$0.13$  ex GST per outage hour over 24 hours.

The Shire of Beverley will be responsible for managing, updating and programming the Cornerstone Digital Display.

The Chief Executive Officer is to determine suitability of display items and approve displays at their discretion.

CORNERSTONE DIGITAL SIGN ADVERTISING TERMS & CONDITIONS

Advertising on the Cornerstone Digital Display is allowable pursuant to the following conditions:

- The Advertising is of a local business; or
- The Advertising of a local profit generating Event; and
- A fee of \$50 ex GST for set up and maintenance and \$50 ex GST per calendar month (paid in advance) to display is paid.

The advertising display will run on a continuous loop between 6.00am and 8.00pm, being the operating period (total 14 hours).

A display will run for a maximum of 10 seconds.

A loop will be for a maximum of 4 minutes or 24 10 second displays per screen.

The minimum exposure per display over the operating time will be 210 times shown during the operating period.

No alteration or discount will be applied to the fee chargeable for paid advertising in the event of reduced exposure from short term (less than 24 hour) power outages or equipment failure.

For outages lasting longer than 24 hours a pro rata refund will be applied to each additional outage hour over 24 hours based on a 28 day month (392 operating hours).

Refund calculation =  $\$50/392 = \$0.13$  ex GST per outage hour over 24 hours.

The Shire of Beverley will be responsible for managing, updating and programming the Cornerstone Digital Display.

The Chief Executive Officer is to determine suitability of display items and approve displays at their discretion.

DECLARATION

I, \_\_\_\_\_ have read, understood and agree to the terms and conditions relating to advertising on the Shire of Beverley's Cornerstone Digital Display.

I approve the exhibition of the approved advertisement for \_\_\_\_\_ to be displayed for the months of \_\_\_\_\_ to \_\_\_\_\_ .

Signed: \_\_\_\_\_

Date: \_\_\_\_\_

### 3.16 Beverley Blarney

<b>Policy Type:</b>	Community
<b>Date Adopted:</b>	27 August 2019

<b>Policy No:</b>	<b>C016</b>
<b>Date Last Reviewed:</b>	25 October 2022

<b>Legal (Parent):</b>	1.
------------------------	----

<b>Legal (Subsidiary):</b>	1.
----------------------------	----

<b>Title:</b>	<b>BEVERLEY BLARNEY</b>
<b>Objective:</b>	<b>To provide guidelines on the production and distribution of the Beverley Blarney.</b>

The Beverley Blarney is a free monthly publication produced by the Shire of Beverley for the benefit of the Community to aid in the distribution of local news, events, announcements and business.

#### Production

The Shire of Beverley may pay a monthly fee to a group, person or business to collate, design and edit the Beverley Blarney on behalf of the Shire of Beverley. The current payment stands with the ~~Beverley Community Resource Centre (CRC)~~ Replace CRC with L. Adams where relevant.

Should the Beverley CRC no longer wish to produce the Beverley Blarney they are to provide two months (two issues) notice. Should the Shire of Beverley no longer wish ~~the Beverley CRC~~ to produce the Beverley Blarney it is to provide three months (three issues) notice.

~~The CRC~~ will monitor the [blarney@beverley.wa.gov.au](mailto:blarney@beverley.wa.gov.au) email address and respond to all advertising requests it receives. Any reports or advertisements that the editor is unsure about should be directed to the Shire CEO for clarification.

Shire staff will assist with any queries received via the Shire Office, directing advertisers to send requests to the blarney email address or taking the advertisement, payment (if necessary) and placing it in the Blarney pigeon hole.

Community Groups with community announcements will not be charged for advertising. A group community announcement is considered as monthly club notes, notice of AGM, posters for open days or activities etc.

Individuals with community announcements will not be charged for advertising. An individual community announcement is considered as either a birthday, anniversary, death or thank you notice.

Local Community Groups with sponsored activities that provide economic benefit to the town are permitted to recognise their sponsors with logos within their advertising. Eg – Beverley Show, Open Days (Sporting Clubs), Triathlon, Station Arts, CRC and BDHS. If there is an advertising query which this policy does not address or remains silent, the query should be referred to the Shire of Beverley Chief Executive Officer.

Where a paid advertisement or community announcement is changed for either information, grammatical or professional beautification purposes, the advert/announcement is to be sent back to the advertiser for approval prior to printing.

The Beverley Blarney does not print offensive opinion pieces or “Brickbats and Bouquets”. Special opinion pieces which are community related and not offensive maybe directed to the Chief Executive Officer and if approved, payment for the advertisement will be required.

Pieces which could be considered helpful to the community may be directed to and approved by the CEO. Political advertising during State and Federal Elections must be paid for. Political media statements maybe approved if the information is relevant and helpful to the Beverley Community.

Private Business will be charged for their advertising at the rate appropriate to the advertising size. Advertising is likely to be moved each month to suit editing and a requested location cannot be guaranteed or accommodated.

The Shire of Beverley and Beverley CRC are not required to pay for advertising.

The monthly Shire President Report is to be located on page two (2) of the Blarney. If possible other Shire information should follow on from the President’s Report.

Payments for advertising will be received or invoiced by the Shire of Beverley. Size D, Size E and Trading Post adverts must be paid at the time of advertising and will not be invoiced. 12 month advertising rates, with 2 free months must be paid upfront and will not be invoiced monthly.

The Beverley Blarney must be proof read by a Shire of Beverley Staff member prior to going to print.

The Beverley Blarney should where possible, be finalised at least two nights prior to the 1<sup>st</sup> of each month.

#### Printing and Distribution

The Shire of Beverley may pay a monthly fee to a group, person or business to print and distribute the Beverley Blarney on behalf of the Shire of Beverley.

Should the group/person/business no longer wish to print and distribute the Beverley Blarney they are to provide one months (one issue) notice. Should the Shire of Beverley no longer wish the group/person/business to print and distribute the Beverley Blarney it is to provide three months (three issues) notice.

The Beverley Blarney should where possible, be printed on the last two nights of the month, ready for distribution on the 1<sup>st</sup> of the month.

The Beverley Blarney is to be distributed to various businesses listed on the Blarney distribution sheet.

If a new business requests to be a distribution point, approval should be given by the Chief Executive Officer (refer to the attached distribution list).

Each quarter the distributor should review any excess copies left at various businesses and adjust if necessary.

#### Social Media

Shire Staff are required to upload the Blarney and Presidents Notes to the Shire Website on the 1<sup>st</sup> day of the month (or Monday should the 1<sup>st</sup> be a Saturday or Sunday).

A link should be placed on the Shire Facebook page advertising the availability of each new issue.

Beverley Blarney Distribution Sheet



Business Name	Quantity
Avon Trading	50
Beverley Pharmacy	40
Elders Beverley	20
Beverley IGA	110
Beverley Post Office & Newsagency	440
Beverley CRC	15
Beverley Shire Counter	20
Shire of Beverley Prepaid Post	20
Beverley Caravan Park	10
Beverley Medical Centre	10
T-Bone Butcher	20
Red Vault	20
East End Gallery	15
Beverley Bakehouse	40
Avondale Museum	15
Beverley Frail Aged Lodge	6
York Tourist Bureau	12

Policy Amended: 23 November 2021

### 3.17 Avondale Agricultural Museum Collection Policy

<b>Policy Type:</b>	Community
<b>Date Adopted:</b>	25 February 2020

<b>Policy No:</b>	<b>C017</b>
<b>Date Last Reviewed:</b>	25 October 2022

<b>Legal (Parent):</b>	1.
------------------------	----

<b>Legal (Subsidiary):</b>	1.
----------------------------	----

ADOPTED POLICY	
<b>Title:</b>	<b>AVONDALE AGRICULTURAL MUSEUM COLLECTION POLICY</b>
<b>Objective:</b>	<b>To provide guidelines on the development and management of the collection.</b>

#### Background

The Avondale Agricultural Museum Collection is located at Avondale Farm, in the Shire of Beverley. Avondale farm is a 710ha property, located 6km west of the Town of Beverley on Waterhatch Road. The property comprises 520ha arable farming land and 190ha non arable land comprising a bush reserve (53.5ha), rocky grazing, treed water courses and a built heritage precinct.

Avondale farm was one of the earliest pastoral properties developed in the Beverley district in the 1830's. Avondale Farm is valued for its role in agricultural research and education. Established as a State Farm in 1919, Avondale Farm was held by the Agriculture Department of WA as a venue for agricultural research from 1924 until the 1990's and subsequently as a public education site until 2009, when the National Trust took over the management of the property.

The original Avondale Agricultural Museum Collection was comprised of items donated by farmers from around the State for the sesquicentenary celebrations in 1979. The exhibition concentrated on items of technological significance, much of which was restored by the Department of Agriculture's workshop. The collection was specifically put together to represent the historical equipment of all the processes in agricultural production and therefore tells the story of the development of farming in the Western Australian Wheatbelt.

The original museum building was constructed to house the donated farm machinery. The building was extended in the early 2000's to house the growing collection that represents some of Western Australia agricultural machinery dating back to the 1850's

The Shire of Beverley took over the collection from the Agriculture Department in 2009, at the same time management of the property was transferred to the National Trust.

#### Statement Of Purpose Or Mission Statement

The purpose of the Avondale Agricultural Museum Collection is to tell the story of the mechanisation and innovation in farming in the Western Australian Wheatbelt region from the early 1850's to 1979.

The Museum aims to provide an educational and tourism experience that is complementary to the interpretation of 'Avondale Farm' which tells the story of the development of Agriculture in WA, intertwining early European settlement, the culture and traditions of the Ballardong Aboriginal people and the natural environment.

The Museum will incorporate objects, history and stories associated with the development of Agriculture in Western Australia, the history of Avondale Farm and the significant contribution made to Agricultural from the research carried out at Avondale.

### **Purpose And Scope Of The Collection Policy**

The collection policy will be the guiding document for the development and management of the collection.

The policy will guide the formation of a management structure, museum funding, a review of the existing collection and subsequent inclusion of items into the Avondale Agricultural Museum collection.

The collection management policy will guide the procedures by which the museum is managed and funded. The procedures developed to implement these policies will be outlined in a separate document.

### **Museum Management**

The Shire of Beverley owns and is responsible for the Avondale Agriculture Museum Collection.

Museum governance, future planning and funding will be the responsibility of the Shire of Beverley.

The Shire of Beverley will be responsible for the operations of the Museum in accordance with the policies and procedures of the Museum.

### **What The Museum Will Collect**

The key theme of the Avondale Agricultural Museum Collection is to tell the story of the mechanisation and innovation in farming in the Western Australian Wheatbelt region. The collection was put together to represent the historical equipment of all the processes in agricultural production and therefore is representative of a class of artefacts important to the development of farming in the Wheatbelt of WA.

The Museum will incorporate objects, history and stories associated with the development of Agriculture in Western Australia, the history of Avondale farm and the significant contribution made to Agricultural research at Avondale.

Contributing significantly to the value of the Museum Collection are the operational vehicles. A large number of the tractors and vehicles are operational, enabling demonstrations of farm practices and differentiating the collection from similar collections throughout WA.

The environs in which the Museum is located at Avondale also adds value to the museum collection and is another differentiating feature. Avondale Farm was an Agricultural research facility which made a significant contribution to agricultural research in the State and is still a working farm.

The collection dates from the 1850's to 1979.

The types of objects to be collected include agricultural machinery, agricultural implements, operating manuals for historical machinery, photographs and written and oral histories.

The objects will reflect the development of Agriculture in WA and could include

- equipment used in agricultural research;
- vehicles and machinery in working order or able to be restored to working order for the purpose of demonstrations;
- historical equipment that contributes to the processes in agricultural production; and
- objects important to the development of farming in the south of WA

The collection is available for viewing at Avondale Farm, 505 Waterhatch Road Beverley. Opening hours are determined by the Shire in consultation with the National Trust (WA) who manage Avondale Farm. Access may be provided for special events by arrangement. Access to Museum records will be provided by appointment only.

Temporary exhibitions may be installed and objects used in demonstrations at special events.

## **How the Museum Will Collect**

### **Method of Acquisition**

The Museum will acquire objects for the permanent collection by donation, bequest, purchase or transfer.

All decisions regarding the acquisition of objects for the museum will be made by the Acquisition Committee.

The museum will not accept conditional donations.

Loans will be considered on a case by case basis, and would normally only be considered where the object is rare and adds significant value to the current museum collection or it would enhance a temporary exhibition or event display. Decisions on items to acquire by loan will be made by the Acquisition committee.

### **Acquisition Committee**

The Acquisition committee will be full Council for the Shire of Beverley. All recommendations made by the committee will be documented and retained in the Shire of Beverley Office.

### **Acquisition Criteria**

The Committee will consider the following criteria before approving acquisition of an object:

- **Relevance**  
The museum only collects objects that relate to the museum's purpose and key collecting areas
- **Significance**  
Priority is given to objects which are significant for their historic, aesthetic, scientific/research or social/spiritual value.
- **Provenance and Documentation**  
Priority will be given to objects from Avondale Farm and surrounding Wheatbelt Shires and where the history of the object is known and associated documentation and support material can be provided. Items can be obtained from other areas where it enhances the understanding of the key themes within the collection.
- **Condition, intactness, integrity**  
The condition of the object must be taken into consideration when acquiring material. Badly damaged material will not normally be accepted into the collection.
- **Interpretive Potential**  
Objects that tell a story that adds to the interpretation of museum themes will be prioritised.
- **Rarity**  
Objects may be prioritised if they are rare examples of a particular kind of object
- **Representativeness**  
Objects may be prioritised if they are an excellent representative example of a particular kind of object
- **Duplications**  
Objects that duplicate items already in the collection will not be accepted unless they are of superior condition and/or historic value. In such a case the duplicate may be considered for deaccessioning.
- **Legal Requirements**  
The museum only accept objects where the donor/vendor has legal title to the object
- **Resource Implications**  
The museum will consider its responsibility in relation to items that have highly specialised conservation, storage and display needs and the ability of personnel to care for these items, including the financial resources required to safely house such items.

## **Legal / Ethical Obligations**

### **Aboriginal Artefacts**

Should objects that are traditional Aboriginal objects be offered to the museum for inclusion in its collection the Shire will comply with the Aboriginal Heritage Act 1972.

The Shire acknowledges that it has a mandatory obligations under the Aboriginal Heritage Act 1972 (WA) to provide notice in writing to the Minister of Aboriginal Affairs in relation to any object in its custody that may be classified as Aboriginal cultural material. The Shire shall give a description of that object and the manner in which it came to be in its custody or under its control.

### **Prohibited Weapons And Firearms**

Should objects that could be considered to be prohibited or controlled weapons be offered to the Museum for inclusion in its collection, the Shire will comply with the Weapons Act 1999 and the Weapons Regulations 1999. Such weapons could include historical swords, blunt ceremonial swords, bayonets, batons, cat o'nine tails, and concealed weapons, firearms including longarms, pistols and handguns.

### **Storage & Conservation**

The Museum aims to achieve high standards of collection care and storage based on the National Standards for Museum and Galleries v1.5.

Objects will be stored and conserved in accordance with the Collection Policy Procedures Manual.

## **Deaccessioning And Disposal Procedures**

### **Criteria For Deaccessioning**

Deaccessioning is the administrative process of removing an item from the collection.

An object can be deaccessioned from the Museum's collection if

- It does not comply with the current collection policy of the Museum.
- It is damaged beyond repair.
- The conservation and storage costs for it are beyond the means of the museum.
- It is a lesser quality duplicate of an object the museum already owns and it is not required for changeover, education or other purposes.
- It lacks any supporting information to enable proper identification or to establish its relevance to the collection.
- It has disputed ownership and a substantiated request for the return of the object to its original owner is received

### **Deaccession Procedures**

To formally de-accession an object from the Museum collection the following procedure should be followed:

- The object identified for removal from the collection must come before the Acquisition Committee for consideration with close reference to the criteria stated above. ~~(8.1)~~
- The object identified above for deaccession must be held for a twelve month 'cooling off' period before it is finally disposed of.
- Staff, volunteers, committee members and their families are prohibited from purchasing, or otherwise obtaining, a deaccessioned object, except by public auction or open tender process.
- Any funds acquired from the sale of the de-accessioned item should be used for acquisition or care of the collections.

### **Disposal Procedures**

Once a decision has been made by the Acquisition committee to deaccession an object, the object should be removed from the collection in the following priority order:

1. Returned to the donor or family. If after a thorough search this is impossible, the object should be;
2. Transferred to another appropriate institution;
3. Sold by public auction or open tender process, where appropriate;
4. Used as an education/interpretive tool;
5. Destroyed or recycled if appropriate

### **Winding-Up Procedures**

In the event that the Museum is to be wound up, a resolution of the Beverley Shire Council is required.

The museum will be wound up in accordance with the National Standards for Australian Museums and Galleries v1.5 (in particular A1.1.3 and A1.1.4) or the equivalent standards at the time.

The Shire of Beverley disposal of assets policy will also apply.

## **LOANS**

### **Loan Procedures**

The Museum will consider the lending and borrowing of objects if by doing so it assists the Museum in meeting its purpose. The lending and borrowing of objects will be considered on a case by case basis, and would normally only be considered where the object is rare and adds significant value to the current museum collection or it would enhance a temporary exhibition or event display.

Decisions on items to acquire by loan will be made by the Acquisition committee who will consider the following:

- Permanent and long term loans will not be accepted by the Museum.
- The Museum will loan and borrow material to help meet its purpose.
- The Museum holds separate forms for inward and outward loans
- The maximum loan period is 12 months.

The procedure for inward and outward loans is contained within the Collection Procedures manual.

### **Oral History Policy**

Oral histories form an important part of the Avondale Agricultural Machinery Museum. When collecting oral histories

- An Oral History Agreement is signed by the person interviewed, which clearly states the purpose and intended uses of the interviews and what copyright provisions apply.
- The Museum abides by the Guidelines of Ethical Practise of the Oral History Association of Australia.

Oral histories will be collected, used and made available to the public in accordance to the procedures outlines in the Collection Procedures Manual.

### **Access**

The collection is accessible to the public through regular opening hours and by appointments. Use of the Museum for special events is by arrangement with ~~the MSC, with approval from~~ the Shire of Beverley.

The collection records are accessible for research purposes by appointment.

### **Review Your Collection Policy**

The museum collection policy will be reviewed annually as part of the Shire of Beverley Policy Manual annual review.

### 3.18 Request for Purchase and Placement of Memorial Seats

<b>Type:</b>	Community	<b>Policy No:</b>	<b>C018</b>
<b>Date Adopted:</b>	23 August 2022	<b>Date Last Reviewed:</b>	25 October 2022

<b>Legal (Parent):</b>
------------------------

<b>Legal (Subsidiary):</b>
----------------------------

<b>ADOPTED POLICY</b>	
	<b>Request for Purchase and Placement of Memorial Seats</b>
<b>Objective:</b>	<b>To recognise residents who have made a significant contribution to the Beverley Community and ensure applications are managed on a consistent basis.</b>

#### SCOPE

This policy applies to the placement of memorial seats in the Shire of Beverley owned/managed parks, reserves, public open space and streetscapes (other than Vincent Street).

#### POLICY

The Shire of Beverley recognises that members of the community may wish to use public open space to commemorate a person/s through a memorial, which adds to the value of the well being of the community.

In order for the Shire to ensure its public open spaces continue to serve their purpose and are not transformed into places of mourning, and that its assets are not impacted negatively, applications for memorial seats in public open space will be limited to:

- recognising residents who have made a significant contribution to the Shire or Community over a minimum of 15 years.

Each application will be assessed on its individual merit, firstly meeting the basic criteria and subject to the conditions within this policy.

All applications must meet the following criteria:

- The application must be on the prescribed form.
- Memorial seats shall only commemorate a person no longer living.
- The deceased was a resident of Beverley for a minimum of 15 years.
- The deceased made a significant contribution to the community through volunteering, business, cultural, social or sporting aspects.
- Placement of the memorial would benefit the community in acknowledging the deceased.
- The applicant is to fund the purchase and installation of the memorial seat and plaque.

## **IMPLEMENTATION**

- The application will be presented to Council for determination.
- The requested location will be considered, but final determination will be by the CEO or Manager of Works.
- The Shire will co-ordinate the selection, purchase, installation, and maintenance of the seat and plaque.
- All plaques will be to a standard size and be purchased through an approved bronze plaque foundry.
- Personal items are not to be fixed to the memorial seat or placed at the base of the seat.
- No ashes are to be placed in or near the seat.
- Additional plaques may be approved on memorial seats subject to approval from the original applicant or their immediate family.

### **Life of the Seat and Plaque**

The seat and plaque remain the property of the Shire of Beverley. The memorial seat and plaque have a finite life. The Shire envisages that the seat/plaque will be located at the site for a period of not less than 10 years from the date of installation. Should a piece of memorial park furniture be damaged beyond repair, it will be deemed to be at the end of its useful life and the Shire will use reasonable endeavours to contact the applicant to inform them of this.

### **Cost**

Applicants must meet the cost of the purchase and installation of furniture and plaque. Costs are determined on a case by case basis. Applicants will be advised the total cost prior to the application being presented to the CEO or Council for consideration. Applicants can advise at this stage if they do not wish to proceed with the application. Costs are to be paid in full before the Shire will undertake the purchase of the memorial.

### **Plaques**

The memorial plaque can be no larger than 120mm x 80mm and be up to 20 words.



**Memorial Seat and Plaque Application Form****APPLICANT:**

First Name:	
Surname:	
Postal Address:	
Email:	
Mobile:	
Alternate Contact Name:	
Mobile and Email:	

**MEMORIAL:**

First Name:	
Surname:	
Date (from to) Lived in Beverley	
Contribution to Beverley Community:	

**PLAQUE DETAILS**

Wording (max of 20 words)	
------------------------------	--

Please number your preferred location, with 1 being most preferred

Location	
Avon River Park	
Avon Park – RV Friendly side	
Information Bay	
Streetscape/Footpath (please name road)	
Catholic Cemetery	
Anglican Cemetery	
Other -	

- I accept the final location will be decided by the Shire of Beverley.  
 I have read the Memorial Seats Policy and understand the payment, implementation and life of memorial conditions.

Signed: \_\_\_\_\_ Date: \_\_\_\_\_

### 3.19 Child Safe Awareness Policy

<b>Policy Type:</b>	Community
<b>Date Adopted:</b>	27 June 2023

<b>Policy No:</b>	<b>C019</b>
<b>Date Last Reviewed:</b>	

<b>Legal (Parent):</b>
1. N/A

<b>Legal (Subsidiary):</b>
2.

ADOPTED POLICY	
<b>Title:</b>	<b>CHILD SAFE AWARENESS POLICY</b>
<b>Objective:</b>	<b>To reduce the risk of harm and child sexual abuse in our community by encouraging child safe environments to be created and maintained.</b>

#### **POLICY STATEMENT**

The Shire of Beverley supports and values all children and young people. The Shire of Beverley makes a commitment to support the safety and wellbeing of all children and young people, including protection from abuse. This Child Safe Awareness policy is one of the ways the Shire of Beverley demonstrates its commitment to being child safe and a zero-tolerance approach to child abuse.

This policy aims to reduce the risk of harm and child sexual abuse in our communities by encouraging child safe environments to be created and maintained. The Shire of Beverley is committed to encouraging local organisations to be child safe and ensure children are safe and empowered.

This Child Safe Awareness policy has been developed in response to recommendation 6.12 of the Royal Commission into Institutional Responses to Child Sexual Abuse and recognises that the Shire of Beverley is uniquely placed within the local community to demonstrate leadership by supporting organisations to be child safe and to protect children and young people from harm and/or abuse. The Shire of Beverley will promote the safety and wellbeing of children across the community.

Consistent with the National Principles for Child Safe Organisations and Commonwealth Child Safe Framework, this policy provides a framework that outlines the role of the Shire of Beverley in supporting local organisations to be child safe through access to resources, awareness raising and sharing relevant information.

#### **Scope**

The safety and wellbeing of children is everyone's responsibility. This Child Safe Awareness policy applies to all, employees, volunteers, trainees, work experience students, interns, and anyone else who undertakes work on behalf of the Shire of Beverley, regardless of their work related to children or young people. It applies to occupants of the Shire of Beverley facilities and venues, including visitors, contractors and suppliers.

**Definitions:**

**Abuse:** Abuse is an act, or a failure to act, towards or on behalf of a child that may result in harm. It can occur on one occasion or multiple occasions. Sometimes the impact of multiple events leads to harm that becomes cumulative in nature. Types of abuse include physical, emotional and sexual abuse, and neglect.

**Child/Children:** Means a person under 18 years of age, and in the absence of positive evidence as to age, means a person who appears to be under 18 years of age.

**Child Safe Organisation:** is defined in the Royal Commission Final Report as one that:

- creates an environment where children's safety and wellbeing are at the centre of thought, values, and actions
- places emphasis on genuine engagement with and valuing of children and young people
- creates conditions that reduce the likelihood of harm to children and young people
- creates conditions that increase the likelihood of identifying any harm, and
- responds to any concerns, disclosures, allegations, or suspicions of harm. Note: in the context of local governments, this would involve referring concerns to the Department of Communities or WA Police to respond as appropriate.

Implementation of the National Principles for Child Safe Organisations give effect to the above.

**Child safe:** For the purpose of this policy, child safe means protecting the rights of children and young people to be safe by taking actions that can help prevent harm and abuse.

**Harm:** Harm, in relation to a child, means any detrimental effect of a significant nature on the child's wellbeing, whether caused by a single act, omission or circumstance; or a series or combination of acts, omissions or circumstances.

**Wellbeing:** Wellbeing of children and young people includes the care, development, education, health and safety of children and young people.

**Policy Principles**

- The rights of children and young people are upheld.
- Children and young people are respected, listened to, and informed about their rights.
- Children and young people have the fundamental right to be safe and cared for.
- Children and young people have the right to speak up, be heard and taken seriously without the threat of negative consequences.
- The safety and best interests of children and young people are a primary consideration when making decisions that concern them.
- Access to trusted and reliable information, including the National Principles for Child Safe Organisations, helps support organisations to understand what they must do to help reduce the risk of harm and abuse.
- Communities are informed and involved in promoting the safety and wellbeing of children and young people including protection from harm.
- Collaboration with the community and our partners promotes the safety, participation and empowerment of all children and young people.

**Policy Functions**

The Shire of Beverley will ensure the following functions of this policy are resourced and assigned to the relevant officers for implementation.

- Developing a process to deliver child safe messages (for example Agenda at Shire venues, grounds and facilities or events).
- Connecting and supporting local community groups, organisations, and stakeholders to child safe resources (including culturally safe and inclusive resources).

**Responsibilities**

The Shire of Beverley has a leadership role in our community to support relevant organisations to be child safe and promote child safe practices.

Although the Shire of Beverley is not legally responsible for providing oversight of compliance with child safe practices, it will take any reasonable steps to engage with persons who utilise the Shire of Beverley facilities to operate in alignment with the Child Safe Awareness policy.

The Shire of Beverley will determine which roles across the organisation will directly support the implementation of the Child Safe Awareness policy.

**Related Policies**

Shire of Beverley Elected Member & Employee Code of Conduct

**Review**

This policy will be reviewed within the Annual Shire of Beverley Policy Manual Review or upon the introduction of other relevant policy or legislation related to the safety and wellbeing of children and young people.

## 4. *Elected Members*

### 4.1 Ordinary Meetings of Council

<b>Policy Type:</b>	Elected Members
<b>Date Adopted:</b>	September 2014

<b>Policy No:</b>	<b>EM001</b>
<b>Date Last Reviewed:</b>	25 October 2022

<b>Legal (Parent):</b>
1. Local Government Act 1995

<b>Legal (Subsidiary):</b>
1.

ADOPTED POLICY	
<b>Title:</b>	<b>ORDINARY MEETINGS OF COUNCIL</b>
<b>Objective:</b>	<b>To advise of Ordinary Council Meeting Times.</b>

#### Policy

Ordinary Meetings of Council are generally held on the fourth ~~Tuesday~~ ~~Wednesday~~ of each month, except for January and December.

Council Briefing to commence at 1.00pm.

Ordinary Meeting to commence at 3.00pm.

Policy Amended: 26 September 2017

Policy Amended: 27 August 2019

Policy Amended: 22 September 2020



## 4.2 Council Agendas

<b>Policy Type:</b>	Elected Members
<b>Date Adopted:</b>	September 2014

<b>Policy No:</b>	<b>EM002</b>
<b>Date Last Reviewed:</b>	25 October 2022

<b>Legal (Parent):</b>
1. Local Government Act 1995

<b>Legal (Subsidiary):</b>
1.

ADOPTED POLICY	
<b>Title:</b>	<b>COUNCIL AGENDAS</b>
<b>Objective:</b>	<b>To provide guidelines for the production and distribution of Council Agendas.</b>

### Policy

Ordinary Council meeting Agendas are distributed to the following persons:

Councillors  
 Chief Executive Officer  
 Deputy Chief Executive Officer  
 Shire Planner  
 Works Supervisor  
 Administration Workers to share a copy

Additionally, a copy is available on the Shire website.

Subject to individual Councillors discretion, the Notice of Meetings, agendas including all confidential items, other information bulletins and corporate discussion papers will be delivered electronically.

Conditions:

1. Agenda items requiring a decision to be made by Council are to be submitted in writing to the Chief Executive Officer by close of business on the Tuesday, eight days before the meeting.
2. The Agenda is to be distributed a minimum of 72 hours before the Meeting Date as per the Local Government Act 1995. Shire of Beverley staff will distribute any agenda no later than 5pm ~~Thursday~~ **Friday** prior to a ~~Tuesday~~ **Wednesday** meeting.
3. The inclusion and distribution of late items is at the discretion of the Chief Executive Officer.

Policy Amended: 23 October 2018  
 Policy Amended: 27 August 2019  
 Policy Amended: 22 September 2020  
 Policy Amended: 23 November 2021  
 Policy Amended: 25 October 2022

### 4.3 Media Statements and Public Relations

<b>Policy Type:</b>	Elected Member
<b>Date Adopted:</b>	September 2014

<b>Policy No:</b>	<b>EM003</b>
<b>Date Last Reviewed:</b>	25 October 2022

<b>Legal (Parent):</b>
1.

<b>Legal (Subsidiary):</b>
1.

<b>ADOPTED POLICY</b>	
<b>Title:</b>	<b>MEDIA STATEMENTS AND PUBLIC RELATIONS</b>
<b>Objective:</b>	<b>To provide guidelines for communicating to outside parties.</b>

#### Policy

Publicity of Shire of Beverley activities through the media will be by the authority of the President or, where the President agrees, the Chief Executive Officer. Media releases and statements are to be confirmed by the President before distribution.

A press release file is to be maintained for reference purposes.



## 4.4 Conference and Meeting Expenses

<b>Policy Type:</b>	Elected Members
<b>Date Adopted:</b>	September 2014

<b>Policy No:</b>	<b>EM004</b>
<b>Date Last Reviewed:</b>	25 October 2022

<b>Legal (Parent):</b>
1.

<b>Legal (Subsidiary):</b>
1.

<b>ADOPTED POLICY</b>	
<b>Title:</b>	<b>CONFERENCE AND MEETING EXPENSES</b>
<b>Objective:</b>	<b>To establish guidelines for payment of Councillor conferences and meetings.</b>

### Policy

Where a Councillor is authorised to attend a conference, meeting, course or other Council business as defined in Policy EM011 Attendance at Events, the Shire of Beverley will pay for:

- fees at cost;
- travel, to be paid at ATO Travel Rates;
- Councillor's accommodation; and
- meals and other incidentals with these expenses to a maximum of \$150 per day.

Additionally, the Shire of Beverley will pay for spouses to attend any official partner programme connected with the conference.

Policy Amended: 25 October 2016  
 Policy Amended: 23 November 2021

## 4.5 Honour/Photo Board

<b>Policy Type:</b>	Elected Members
<b>Date Adopted:</b>	September 2014

<b>Policy No:</b>	<b>EM005</b>
<b>Date Last Reviewed:</b>	25 October 2022

<b>Legal (Parent):</b>
1.

<b>Legal (Subsidiary):</b>
1.

<b>ADOPTED POLICY</b>	
<b>Title:</b>	<b>COUNCILLOR HONOUR AND PHOTO BOARDS</b>
<b>Objective:</b>	<b>To provide guidelines for the information provided on Councillor Honour and Photo Boards located in the Shire of Beverley office.</b>

### Policy

The Honour/Photo Board is to be updated after elections or as necessary.

Details to be listed under the photo are: surname, initials, the year of election/commencement and retirement/termination, including titles but excluding honours, for:

- (a) each Councillor, for each period of service;
- (b) Presidential service; and
- (c) each Chief Executive Officer appointed.

## 4.6 Recording Voting of Motions

<b>Policy Type:</b>	Elected Members
<b>Date Adopted:</b>	September 2014

<b>Policy No:</b>	<b>EM006</b>
<b>Date Last Reviewed:</b>	25 October 2022

<b>Legal (Parent):</b>
1. Local Government Act 1995

<b>Legal (Subsidiary):</b>
1.

ADOPTED POLICY	
<b>Title:</b>	<b>RECORDING VOTING OF MOTIONS</b>
<b>Objective:</b>	<b>To provide guidelines for recording votes in all Council Meetings.</b>

### Policy

~~The minute taker must record the mover and seconder of each motion and the number of votes for/against all motions at all Council Meetings.~~

~~The recording of personal voting is not required, unless a Councillor specifically asks for their vote to be recorded.~~

The minute taker is required to record voting information against each motion voted on at a council or committee meeting. This information includes the:

- total votes cast for a motion
- total votes cast against a motion
- individual vote of each member of the council or committee for each motion.

## 4.7 Elected Member Allowances

<b>Policy Type:</b>	Elected Members
<b>Date Adopted:</b>	September 2014

<b>Policy No:</b>	<b>EM007</b>
<b>Date Last Reviewed:</b>	25 October 2022

<b>Legal (Parent):</b>
1. Local Government Act 1995

<b>Legal (Subsidiary):</b>
1. Local Government Advisory Board

ADOPTED POLICY	
<b>Title:</b>	<b>ELECTED MEMBER ALLOWANCES</b>
<b>Objective:</b>	<b>To comply with payment of sitting fees as set by legislation.</b>

### Policy

As set by legislation, advice from Local Government Advisory Board and the Salaries & Allowance Tribunal the Shire of Beverley is to pay sitting fees according to the band rate that it sits in.

Sitting Fees are to be paid to Councillors as a lump sum bi-annually and in leave of absence of 3 months or longer, pro-rata bi-annually.

Policy Amended: 25 October 2016

Policy Amended: 23 October 2018

Policy Amended: 27 August 2019

## 4.8 Standing Committees

<b>Policy Type:</b>	Elected Members
<b>Date Adopted:</b>	September 2014

<b>Policy No:</b>	<b>EM008</b>
<b>Date Last Reviewed:</b>	25 October 2022

<b>Legal (Parent):</b>
1. Local Government Act 1995

<b>Legal (Subsidiary):</b>
1.

ADOPTED POLICY	
<b>Title:</b>	<b>STANDING COMMITTEES</b>
<b>Objective:</b>	<b>This policy lists committees of Council and non-Council committees. Committees are decided biannually by Council directly following the Local Government Elections and there for this policy will be altered accordingly.</b>

### Policy

#### **Committees of Council**

Audit and Risk Committee – ~~Three~~ **Four** Councillors

Corporate Strategy Committee – All Councillors

~~Economic & Community Strategy Committee – All Councillors~~

Cropping Committee – ~~Three~~ **Four** Councillors

Works Committee – Four Councillors

CEO Review Committee – President, Deputy President and ~~Chair of Audit Committee~~ **one other Councillor.**

#### **Legislative Committees**

Central Country Zone of WALGA – 2 Councillors (President and Deputy President)

Fire Control Officers Meeting – President + 1 Councillor

Local Emergency Management Committee – President + 1 Councillor

If a Community Committee wishes to have a Councillor at their meeting or on their committee, they must write to Council to request representation.

Committee positions will be allocated after each election.

Policy Amended: 26 September 2017

Policy Amended: 27 August 2019

Policy Amended: 23 November 2021

## 4.9 Electoral Caretaker Period Policy

<b>Policy Type:</b>	Elected Members
<b>Date Adopted:</b>	25 September 2018

<b>Policy No:</b>	<b>EM009</b>
<b>Date Last Reviewed:</b>	25 October 2022

<p><b>Legal (Parent):</b></p> <p>1. Sections 4.87, 5.93 and 5.103 of the <i>Local Government Act 1996</i></p> <p>2. Regulation 8 of the <i>Local Government (Rules of Conduct) Regulations 1996</i></p>
---------------------------------------------------------------------------------------------------------------------------------------------------------------------------------------------------------

<p><b>Legal (Subsidiary):</b></p> <p>1.</p>
---------------------------------------------

ADOPTED POLICY	
<b>Title:</b>	<b>ELECTORAL CARETAKER PERIOD POLICY</b>
<b>Objective:</b>	This Policy establishes protocols for the purpose of preventing actual and perceived advantage or disadvantage to a candidate in a Local Government Election, through the use of public resources or decisions made by the Council or administration on behalf of the Shire of Beverley during the period immediately prior to an election

### Policy Objective

This Policy establishes protocols for the purpose of preventing actual and perceived advantage or disadvantage to a candidate in a Local Government Election, through the use of public resources or decisions made by the Council or administration on behalf of the Shire of Beverley during the period immediately prior to an election.

### Policy Scope

This policy applies to Council Members and Employees and specifically applies during a 'Caretaker Period' to:

- (a) Decisions made by the Council;
- (b) Decisions made under delegated authority;
- (c) Decisions made administratively;
- (d) Promotional materials published by the Shire of Beverley
- (e) Discretionary community consultation;
- (f) Events and functions, held by the Shire of Beverley or other organisations;
- (g) Use of the Shire of Beverley's resources;
- (h) Access to information held by the Shire of Beverley.

### Policy Statement

#### **1. Definitions:**

'**Caretaker Period**' means the period of time prior to an Election Day, specifically being the period from the close of nominations (37 days prior to the Election Day in accordance with s.4.49(a) of the *Local Government Act 1995*) until 6.00pm on Election Day.

'**CEO**' means the Chief Executive Officer of the Shire of Beverley.

'**Election Day**' means the day fixed under the *Local Government Act 1995* for the holding of any poll needed for an election. For the purposes of this Policy, 'Election Day' meaning generally excludes an Extraordinary Election Day unless otherwise specified in this Policy.

**‘Electoral Material’** means any advertisement, handbill, pamphlet, notice, letter, email, social media post or article that is intended or calculated to affect an Election Day result, but does not include:

- (a) An advertisement in a newspaper announcing the holding of a meeting (s.4.87 (3) of the *Local Government Act 1995*); or
- (b) Any materials exempted under Regulation 78 of the *Local Government (Elections) Regulations 1997*; or
- (c) Any materials produced by the Shire of Beverley relating to the election process by way of information, education or publicity, or materials produced by or on behalf of the Returning Officer for the purposes of conducting an election.

**‘Events and Functions’** means gatherings for the purpose of discussion, review, acknowledgement, communication, consultation, celebration or promotion, of any matter relevant to the Shire of Beverley and / or its stakeholders and may take the form of conferences, workshops, forums, launches, promotional activities, social occasions such as dinners and receptions, including; gatherings coordinated or facilitated by the Shire of Beverley or an external entity.

**‘Extraordinary Circumstances’** means a circumstance that requires the Council to make or announce a Major Policy Decision during the Caretaker Period because, in the CEO’s opinion, delaying the decision or announcement to occur after the Caretaker Period has reasonable potential to:

- (a) incur or increase legal, financial and/or reputational risk; or
- (b) cause detriment to the strategic objectives of the Shire of Beverley.

**‘Major Policy Decision’** means any decision:

- (a) Relating to the employment, remuneration or termination of the CEO or any other designated Senior Employee [s.5.37], other than a decision to appoint an Acting CEO, or suspend the current CEO (in accordance with the terms of their Contract of Employment), pending the Election Day result;
- (b) Relating to the Shire of Beverley entering into a sponsorship arrangement with a total Shire of Beverley contribution that would constitute Significant Expenditure, unless the Council resolved “in principle” support for the sponsorship prior to the Caretaker Period taking effect and sufficient funds are allocated in the Annual Budget;
- (c) Relating to the Shire of Beverley entering into a commercial enterprise as defined by Section 3.59 of the *Local Government Act 1995*;
- (d) That would commit the Shire of Beverley to Significant Expenditure or actions that, in the CEO’s opinion, are significant to the Local Government operations, strategic objectives and / or will have significant impact on the community,
- (e) To prepare a report, initiated by the Administration, a Council Member, candidate or member of the public that, in the CEO’s opinion, may be perceived as or is actually an election campaign issue;
- (f) Initiated through a Notice of Motion by a Council Member, where the effect of that motion will change the status quo or, in the CEO’s opinion, may be relevant to the circumstances described in sub-clauses (a) to (e) above.
- (g) That adopts a new policy, service or service level or significantly amends an existing policy, service or service level, unless the decision is necessary to comply with legislation.
- (h) That initiates or adopts a new Local Planning Scheme, amendment to a Local Planning Scheme or Planning Policy.
- (i) Major Policy Decision does NOT include any decision necessary in response to an Emergency, either declared by the State or Federal Government or by the Shire of Beverley in accordance with s.6.8(1)(c) of the *Local Government Act 1995*.

**‘Caretaker Protocol’** means the practices or procedures prescribed in this Policy.

**‘Public Consultation’** means a process which involves an invitation to individuals, groups, organisations or the wider community to provide comment on a matter, proposed action or proposed policy which may be perceived as or is actually an electoral / campaign issue, but does not include statutory consultation / submission periods prescribed in a written law.

**‘Significant Expenditure’** means expenditure that exceeds 0.1% of the Shire’s annual budgeted revenue (inclusive of GST) in the relevant financial year.

## 2. Caretaker Period Protocols - Decision Making

The CEO will ensure that:

- (a) Council Members and employees are advised in writing of the impending Caretaker Period and Policy requirements at least 30-days prior to the commencement of a Caretaker Period.
- (b) Candidates are provided with a copy of this Policy at the time of their nomination for election, to ensure their awareness of the protocols and equitable access requirements.

## **2.1 Scheduling Major Policy Decisions**

1. During a Caretaker Period, unless Extraordinary Circumstances apply, the CEO will reasonably ensure that:
  - (a) Council or Committee Agenda, do not include reports and / or recommendations that constitute Major Policy Decisions; and
  - (b) Council Forums, Workshops or Briefings, do not list for discussions matters that relate to Major Policy Decisions.
2. The CEO shall reasonably ensure that, unless Extraordinary Circumstances apply, Major Policy Decisions are either:
  - (a) Considered by the Council prior to the Caretaker Period; or
  - (b) Scheduled for determination by the incoming Council.
3. The CEO shall reasonably ensure that, unless Extraordinary Circumstances apply, Delegated Authority from the Council to the CEO or a Committee is not exercised where the exercise of that delegated authority relates to a Major Policy Decision or an election campaign issue.

## **2.2 Council Reports Electoral Caretaker Period Policy Statement**

Each report included in an Agenda for Council's consideration during a Caretaker Period, will include a statement that demonstrates due consideration of the requirements of this Policy.

If the matter is not a Major Policy Decision, the following statement must appear in the Report:

### **Electoral Caretaker Period Policy Statement**

The Officer Recommendation has been reviewed in context of the Shire's Electoral Caretaker Period Policy and the CEO has determined that it does not constitute a Major Policy Decision. The CEO therefore provides this report for Council's consideration.

### **2.2.1 Extraordinary Circumstances**

#### **1. Council Reports**

Where, during a Caretaker Period, the CEO determines that Extraordinary Circumstances apply, the CEO may submit a report on a Major Policy Decision for Council's consideration, subject to the report including:

- (a) Details, if applicable, of:
  - (i) Options for what aspects of the decision are necessary to be made within the Caretaker Period and what aspects may be deferred until after the Caretaker Period.
  - (ii) How potential electoral impacts will be managed or mitigated.
- (b) An Electoral Caretaker Period Policy Statement, which details why Extraordinary Circumstances apply.
- (c) An Officer Recommendation, for Council's to accept Exceptional Circumstances apply and receive the report for consideration. This Recommendation is to be considered and resolved by Council, prior to debate of the substantive recommendation relating to the Major Policy Decision.

### **Electoral Caretaker Period Policy Statement**

The Officer Recommendation has been determined as a Major Policy Decision within the context of the Shire's Electoral Caretaker Period Policy for the following reasons:

- [list reasons]

In accordance with the Shire's Electoral Caretaker Period Policy, the CEO seeks a Council Resolution to enable Council's consideration of the matter due to the following Exceptional Circumstances:

- [list reasons]



**Officer Recommendation**

That Council, in accordance with the Electoral Caretaker Period Policy, determines in regard to the Report titled "*insert report title*" to:

1. Accept that Exceptional Circumstances exist: and therefore
2. Receives the Report for Council's consideration.

**2. Council Forums, Workshops or Briefings**

Where, during a Caretaker Period, the CEO determines that Extraordinary Circumstances apply, the CEO may include matters relating to a Major Policy Decision for Council Member discussion at Council Forums, Workshops or Briefings.

The CEO is required to provide Council with advice as to why Exceptional Circumstance apply and how potential electoral impacts will be managed or mitigated. Details of this advice is to be retained, with the Forum, Workshop or Briefing notes, as a Local Government record.

**2.3 Managing CEO Employment**

This Policy, prohibits Major Policy Decisions relating to the employment, remuneration or termination of the CEO during a Caretaker Period.

The Council is however required to fulfil its obligations as the CEO's employer regardless of a Caretaker Period. Therefore, during a Caretaker Period:

1. The Council may consider and determine:
  - (a) CEO's leave applications;
  - (b) appoint an Acting CEO, where necessary;
  - (c) suspend the current CEO, where appropriate and in accordance with the terms of their contract)
2. The Council may not initiate a new CEO recruitment process or initiate or undertake a CEO performance review process, during a Caretaker Period.

**2.4 Delegated Authority Decision Making in Extraordinary Circumstances**

During a Caretaker Period, Employees who have Delegated Authority shall not exercise that delegated authority where the matter relates to a Major Policy Decision or an election campaign issue. All such decisions under delegated authority must be referred to the CEO for review in consideration of clause 2.1(3) above.

**3. Caretaker Period Protocols - Candidates**

Part 3 of this Policy, inclusive of its sub-clauses, applies to a Caretaker Period relevant to Election Days and Extraordinary Election Days.

Candidates, including Council Members who have nominated for re-election, shall be provided with equitable access to the Shire's public information.

The CEO shall ensure that assistance and advice provided to candidates as part of the conduct of the election is provided equally to all candidates.

Council Members nominating for re-election, may access information and assistance regarding the Shire's operations and Council matters during a Caretaker Period, but only to the extent necessary to perform their role as a Councillor and limited to matters currently relevant to the Shire.

All election process enquiries from Candidates, including Council Members who have nominated for re-election, will be directed to the Returning Officer, or where the matter is outside the responsibility of the Returning Officer, to the CEO.

### **3.1 Candidate Requests on behalf of Electors, Residents or Ratepayers**

Candidates, including Council Members who have nominated for re-election, may advise the Shire of Beverley where they have received elector, resident or ratepayer requests for advice, information or responses to matters relevant to the Shire.

Responses will not be provided to the candidate on the basis that the provision of responses to enquiries from electors, residents or ratepayers regarding the operations of the Local Government is an administrative function (refer Regulation 9 of the *Local Government (Rules of Conduct) Regulations 2007*).

Therefore, candidates requests made on behalf of an elector, resident or ratepayer, will be responded to by the Shire's Administration directly to the requesting elector, resident or ratepayer.

### **3.2 Candidate Campaign Electoral Materials**

Candidates, including Council Members who have nominated for re-election, are prohibited from using the Shire's official crest or logo in any campaign Electoral Materials.

### **3.3 Candidate attendance at Meetings**

To ensure equitable access to information about Council's decision making during a Caretaker Period, the CEO shall ensure that Candidates, who are not sitting Council Members, are advised of Ordinary and Special Council Meetings (if open to the public) called and convened during a Caretaker Period; providing each Candidate with a copy of the meeting agenda at the time it is distributed to Council Members.

For the purposes of transparency and the benefit of the public gallery, Candidates are requested to identify themselves as an election candidate prior to asking a question or making a statement at a Council or Committee meeting.

## **4. Council Member Caretaker Period Protocols**

Part 4 of this Policy, inclusive of its sub-clauses, applies to a Caretaker Period relevant to Election Days and Extraordinary Election Days.

### **4.1 Access to Information and Advice**

All Council Members will scrupulously avoid using or accessing Shire of Beverley information, resources or employee resources and expertise for the purpose of gaining electoral advantage or disadvantage relevant to their own candidacy or any other person's candidacy.

All Council Member requests for information and advice from the Shire will be reviewed by the CEO and where the subject of the information or advice is considered as being related to an election campaign issue, the CEO will have absolute discretion to determine if the information or advice is / is not provided, including where information is provided to one candidate, if that information is also to be provided to all candidates (i.e. including candidates who are not current Council Members).

### **4.2 Media and Publicity**

All Council Member requests for media advice or assistance during a Caretaker Period, including Council Members who have nominated for re-election, will be referred to the CEO for review.

The CEO will only authorise Council Member access to media advice or assistance where, in the CEO's opinion, the subject matter is relevant to the Shire's objectives or operations and is not related to an election campaign purpose or issue or to the Council Member's candidacy or the candidacy of another person.

### **4.3 Council Member Business Cards, Shire Printed Materials**

Council Members must ensure that Shire business cards and printed materials are only used for purposes associated with their role of a Councillor, in accordance with section 3.10 of the *Local Government Act 1995*.

Council Members are prohibited from using Shire business cards or printed materials at any time, including times outside a Caretaker Period, for any election campaign purpose, either in support of their own candidacy or the candidacy of another person.

#### **4.4 Council Member Participation in Events and Functions**

During a Caretaker Period Council Members may continue to fulfil their role through attendance at events and functions hosted by external bodies.

#### **4.5 Council Member Delegates to External Organisations**

At any time, including times outside of a Caretaker Period, Council Members who are the Council's appointed delegate to an external organisation, must not use their attendance at an external organisation's meeting, event or function for any purpose associated with an election campaign purpose, including; recruiting campaign assistance or to promote their own candidacy or the candidacy of another person.

#### **4.6 Council Member Addresses / Speeches**

Excluding the Shire President and Deputy Shire President, when fulfilling their functions prescribed in sections 2.8 and 2.9 of the *Local Government Act 1995*, Council Members who have nominated for re-election, shall not be permitted to make speeches or addresses during a Caretaker Period at events or functions organised or sponsored by the Shire, unless expressly authorised by the CEO.

In any case, the Shire President, Deputy Shire President and Council Members are prohibited from using an official speech or address during a Caretaker Period to promote an election campaign purpose.

#### **4.7 Council Member Misuse of Local Government Resources**

A Council Member who uses Shire of Beverley resources for the purpose of persuading electors to vote in a particular way is a "misuse of Local Government resources" breach in accordance with Regulation 8 of the *Local Government (Rules of Conduct) Regulations 2007*.

This prohibition on misuse of Local Government Resources for electoral purposes applies at all times and is not only applicable to a Caretaker Period.

For clarity, Local Government resources includes, but is not limited to: employee time or expertise, Shire provided equipment, stationery, hospitality, images, communications, services, reimbursements and allowances provided by the Shire.

### **5. Shire of Beverley Publicity, Promotional and Civic Activities**

Part 5 of this Policy, inclusive of its sub-clauses, applies to a Caretaker Period relevant to Election Days and Extraordinary Election Days.

Publicity campaigns and promotional activities during a Caretaker Period may be undertaken only for the purposes of:

- (a) Promoting Shire of Beverley services and activities, where such promotion do not relate to an electoral campaign issue and would otherwise be undertaken as part of normal operations; and,
- (b) Conducting the Election and promoting Elector participation in the Election

All other, publicity and promotional activities of Shire initiatives will be, where reasonably practicable, avoided during the Caretaker Period, including the announcement of Major Policy Decisions, made prior to the commencement of a Caretaker Period or proposed to be made after a Caretaker Period.

The CEO may determine if Exceptional Circumstances apply and if a Major Policy Decision announcement is necessary during a Caretaker Period.

#### **5.1 Civic Events and Functions**

The Shire of Beverley will avoid the scheduling of Civic Events and Functions during a Caretaker Period, so as to avoid any actual or perceived electoral advantage that may be provided to Council Members who have nominated for re-election.

Where the Shire is required to schedule a Civic Event or Function during a Caretaker Period, all Candidates will be invited to attend and will be provided with the similar prominence and protocol courtesies as provided to Council Members. For example; Candidates will be introduced at the function immediately following the introduction of Council Members.

## **5.2 Shire of Beverley Publications and Communications**

All Shire of Beverley publications and communications distributed during a Caretaker Period must not include content that:

- (a) may actually, or be perceived to, persuade voting in an election; or
- (b) is specific to a candidate or candidates, to the exclusion of other candidates;
- (c) draws focus to or promotes a matter which is a Major Policy Decision or which is an electoral campaign issue.

All Shire publications and communications proposed to occur immediately prior to, throughout or during, a Caretaker Period must be reviewed and approved by the CEO prior to publication or distribution.

## **5.3 Shire of Beverley Website and Social Media Content**

1. During the Caretaker Period, the Shire's website and social media will not contain any material which does not accord with the requirements of this Policy. For example, Council Member profiles will be removed from the website during a Caretaker Period.

Website and social media content regarding Council Members will be limited to: Council Member names, contact details, membership of committees and Council appointments as Shire of Beverley Delegates on external committees and organisations.

2. Historical website and social media content, published prior to a Caretaker Period, and which does not comply with this policy will not be removed.
3. New website or social media content which relates to Major Policy Decisions or election campaign issues will not be published during a Caretaker Period, unless Exceptional Circumstances apply.
4. Content posted by the public, candidates or Council Members on the Shire's social media channels, which is perceived as candidate election campaign material or promotes a candidate or candidates will be removed.

## **5.5 Community Consultation**

Unless consultation is mandated under a written law or Exceptional Circumstances apply, community consultation relevant to Major Policy Decisions or potentially contentious election campaign issues, will not be initiated so that the consultation period is conducted immediately prior to, throughout or concluding during, a Caretaker Period.

## 4.10 Councillor Training and Professional Development Policy

<b>Policy Type:</b>	Elected Members
<b>Date Adopted:</b>	28 July 2020

<b>Policy No:</b>	<b>EM010</b>
<b>Date Last Reviewed:</b>	25 October 2022

<b>Legal (Parent):</b>
3. Part 5, Division 10 of the Local Government Act 1995, section 5.126 and section 5.128

<b>Legal (Subsidiary):</b>
1.

ADOPTED POLICY	
<b>Title:</b>	<b>COUNCILLOR TRAINING AND PROFESSIONAL DEVELOPMENT POLICY</b>
<b>Objective:</b>	<b>To establish guidelines to enable Councillors to meet their statutory obligations in relation to Councillor Training and to promote professional development.</b>

### Objective

To establish guidelines to enable Councillors to meet their statutory obligations in relation to Councillor Training and to promote professional development to maintain and enhance their knowledge and skills in a sector that is fast changing and requires engagement from the Local Community to the Federal Government.

### Scope

This policy applies to all Councillors. Part 5, Division 10 of the Local Government Act 1995 (the Act) describes provisions related to the universal training of Councillors:

- under section 5.126 of the Act, each Councillor must complete training in accordance with the Regulations;
- under section 5.128 of the Act, a local government must prepare and adopt a policy in relation to the continuing professional development of councillors.

### Eligibility

Eligible training and development to which this policy applies will generally be limited to those coordinated and/or run by either:

- a) The Western Australian Local Government Association (WALGA).
- b) The major professional bodies associated with local government.
- c) Accredited organisations offering training relating to the role and responsibilities of Councillors.

### Mandatory Training

a) Councillors are required to complete the Council Member Essentials training modules prescribed by Regulation 35, Local Government (Administration) Regulations 1996 within the first 12 months of their election to Council.

b) The cost of completing the training modules will be funded from the Councillors annual allocation for training activities.

### Request and Approval for Attendance

a) Any approval for conference, seminar or training program attendance is always subject to budgetary funds being available.

b) The Chief Executive Officer may approve Councillors attending the WALGA Convention, the Council Member Essentials training modules, and a training request where there is a specific budget provision and all Councillors have been offered the opportunity to attend.

- c) Requests for course participation or conference attendance may be initiated by the Council Member and should be forwarded to the Chief Executive Officer in a reasonable time prior to enrolment or registration.
- d) Any request for training/development within three months of any election process for the seat held by the Councillor making the application will not be eligible for approval unless there are compelling reasons for attendance. This does not include the WALGA Local Government Convention.
- e) Any requests to attend interstate or overseas conferences, seminars or other professional development opportunities, or that will exceed the annual budget allocation will be considered by Council.
- f) The Chief Executive Officer will provide assistance to councillors, where sought, to identify potential targeted professional development opportunities.

**Councillor Induction**

As part of the election process potential Councillors will be given an induction pack by the Chief Executive Officer. Part of that induction pack will include information and recommendations on which training course they are required to attend; code of conduct; meeting schedule;

**Reporting**

A report will be included in each year's Annual Report, and maintained on the Shire of Beverley website, advising the attendance of elected members at events during the year and the total number of mandatory training modules completed by each elected member.

**Costs**

All costs associated with attendance at training activities will be paid by Council in accordance with Policy 4.4 Conference and Meeting Expenses. The Shire will not cover late enrolment fees, additional/optional course materials or any liability incurred under the Higher Education Contributions Scheme (HECS).

## 4.11 Attendance at Events

<b>Policy Type:</b>	Elected Members
<b>Date Adopted:</b>	28 July 2020

<b>Policy No:</b>	<b>EM011</b>
<b>Date Last Reviewed:</b>	25 October 2022

<b>Legal (Parent):</b>
4. Local Government Act 1995, section 5.90A

<b>Legal (Subsidiary):</b>
3. Local Government (Administrations) Regulations 1996

ADOPTED POLICY	
<b>Title:</b>	<b>COUNCILLOR TRAINING POLICY</b>
<b>Objective:</b>	<b>To establish guidelines for appropriate disclosure and management of acceptance of invitations to events or functions, or other hospitality occasions, where elected members and employees are invited free of charge, whether as part of their official duties as council or Shire representatives or not.</b>

### Objective

To establish guidelines for appropriate disclosure and management of acceptance of invitations to events or functions, or other hospitality occasions, where elected members and employees are invited free of charge, whether as part of their official duties as council or Shire representatives or not.

### Scope

This policy applies to all Councillors and all staff at the Shire of Beverley.

In accordance with section 5.90A of the Local Government Act, an event includes, but is not limited to the following:

- a concert
- a conference
- a function
- a sporting event
- occasions prescribed by the Local Government (Administration) Regulations 1996

Travel and accommodation excluded: This policy does not apply to tangible gifts or money, travel or accommodation. Any contribution to travel, subject to the exceptions in section 5.83 of the Local Government Act 1995 (the Act), must be disclosed in writing to the CEO within 10 days of receipt of the contribution.

Contributions to travel costs, whether financial or otherwise are now incorporated within the definition of gift. The following situations are specifically excluded where the event ticket (gift) is received from one of the following organisations:

- WALGA
- LGIS
- Local Government Professionals Australia (WA)
- Australian Local Government Association
- A department of the public service
- A government department of another State, a Territory or the Commonwealth
- A local government or regional local government

The gift is still required to be recorded on the "gift register".

**Statement**

Elected members, the Chief Executive Officer and some Shire staff attend events to fulfil their leadership role in the community. Elected Members and/or the Chief Executive Officer will receive tickets or invitations to attend events to represent the Shire. The event may be a paid event or a ticket/invitation may be gifted in kind.

Attendance is approved for the following events by Elected Members and Shire of Beverley staff:

- Advocacy lobbying or Ministerial briefings
- Meetings of clubs or organisations within the Shire of Beverley
- Any free event held within the Shire of Beverley
- Australian or West Australian Local Government events
- Local Government Professionals Association (WA) events
- LGIS events
- Events hosted by Clubs or Not for Profit Organisations within the Shire of Beverley to which the Shire President, an Elected Member or the Chief Executive Officer or staff has been officially invited
- Shire hosted ceremonies and functions
- Shire hosted events with employees
- Shire run tournaments or events
- Shire sponsored functions or events
- Community art exhibitions
- Cultural events/festivals
- Events run by a Local, State or Federal Government
- Events run by schools and universities within the Shire of Beverley
- Major professional bodies associated with local government at a local, state and federal level
- Opening or launch of an event or facility within the Shire of Beverley
- Recognition of Service events
- RSL events
- Where Shire President, Elected Member or executive staff representation has been formally requested
- Free public events

All Elected Members and executive staff are entitled to attend a pre-approved event. If there is a fee associated with a pre-approved event, the fee, will be paid for by the Shire out of the Shire's budget by way of reimbursement, unless the event is a conference which is dealt with under an alternative Council Policy.

If there are more Elected Members than tickets provided, then the Shire President shall allocate the tickets.

If an elected member (or executive staff) is unable or does not wish to attend the event to which the invitation relates, the member is to advise the event organiser of their unavailability, or may distribute it to another elected member (or member of staff) of their choosing, if the event organiser agrees. Otherwise, it is at the sole discretion of the event organiser, whether the invitation, or tickets, can be redistributed.

**Non Pre-Approved Events - Approval Process**

Where an invitation is received to an event that is not pre-approved, it may be submitted for approval prior to the event as follows:

- Events for the Shire President may be approved by the Deputy Shire President or CEO
- Events for Councillors may be approved by the Shire President or CEO
- Events for the Chief Executive Officer may be approved by the Shire President or Deputy President

**Considerations**

In considering whether a benefit such as an invitation to an event or hospitality given to an elected member or an employee is a gift for the purposes of the Act and Regulations, the key issues include:

- Who is a donor, the person/company who is offering or giving the benefit?
- What is the value of the benefit?



- Any justification provided by the applicant when the event is submitted for approval
- The benefit to the Shire of the person attending
- Alignment to the Shire's Strategic Community Plan
- Does the elected member or employee of the benefit contribute anything of value to the donor in return for the benefit such as formally opening or speaking at the event or presenting prizes/awards?
- If so, does the value of that contribution outweigh the value of the benefit?

If so, it will not be a gift for the purposes of the Act and Regulations.

Where an Elected Member has an event approved through this process, and there is a fee associated with the event, then the cost of the event, will be reimbursed on request. Where the Chief Executive

Officer has an event approved through this process, and there is a fee associated with the event, then the cost of the event is to be paid for out of the Shire's relevant budget allocation.

#### **Non-Approved Events Payment**

Any event that is not pre-approved, is not submitted through an approval process, or is received personally, is considered a non-approved event.

- If the event is ticketed and the Elected Member or Executive Staff pays the full ticketed price and does not seek reimbursement, then no action is required.
- If the event is ticketed and the Elected Member or Chief Executive Officer pays a discounted rate, or is provided with a free ticket(s), with a discount value, then the recipient must disclose receipt of the tickets (and any other associated hospitality) within 10 days to the Chief Executive Officer (or President if the CEO) if the discount or free value is greater than \$300 for Elected Members and the CEO.

#### **Conflict**

Event attendance may create a perceived or actual conflict, which may preclude council members participating or employees providing advice at a future meeting. If the amount of an event ticket (gift) is less than \$1,000, and relates to a matter before Council, under section 5.68 of the Act, Council may allow the disclosing council member to participate on the condition that the interest, the council's decision and the reasons for that decision are recorded in the minutes. If the amount gift is above \$1,000 the council or CEO must apply to the Minister for permission to allow the member or employee to participate.

## 5. *Fire Control*

### 5.1 Restricted and Prohibited Burning Period Dates

<b>Policy Type:</b>	Fire Control
<b>Date Adopted:</b>	September 2014

<b>Policy No:</b>	<b>FC001</b>
<b>Date Last Reviewed:</b>	25 October 2022

<b>Legal (Parent):</b>	1. Bush Fires Act 1954
------------------------	------------------------

<b>Legal (Subsidiary):</b>	1.
----------------------------	----

ADOPTED POLICY	
<b>Title:</b>	<b>RESTRICTED AND PROHIBITED BURNING PERIOD DATES</b>
<b>Objective:</b>	<b>To control the risk of fires.</b>

#### Policy

These dates are determined by the Community Services Emergency Manager and the Chief Fire Control Officer. The dates are to be advised to the public by way of advertising in the Beverley Blarney, the Harvest Ban Hotline, the Shire of Beverley website, SMS, social media pages and the notification board outside the Shire Office.

Policy Amended: 27 August 2019

## 5.2 Burning Times

<b>Policy Type:</b>	Fire Control
<b>Date Adopted:</b>	September 2014

<b>Policy No:</b>	<b>FC002</b>
<b>Date Last Reviewed:</b>	25 October 2022

<b>Legal (Parent):</b>
1. Bush Fire Act 1954

<b>Legal (Subsidiary):</b>
1.

ADOPTED POLICY	
<b>Title:</b>	<b>BURNING TIMES</b>
<b>Objective:</b>	<b>To control the risk of fire.</b>

### Policy

1. That protective burning be permitted during the hours of 5.00pm and 12 Midnight.
2. That burning times under permit are at the times specified by the permit writer.
3. That no burning be allowed within the Shire of Beverley during the Prohibited burning times.

Policy Updated: 25 October 2016

### 5.3 Roadside Verge Burning

<b>Policy Type:</b>	Fire Control
<b>Date Adopted:</b>	September 2014

<b>Policy No:</b>	<b>FC003</b>
<b>Date Last Reviewed:</b>	25 October 2022

<b>Legal (Parent):</b>
1. Bush Fires Act 1954

<b>Legal (Subsidiary):</b>
1.

ADOPTED POLICY	
<b>Title:</b>	<b>ROADSIDE VERGE BURNING</b>
<b>Objective:</b>	<b>To control the risk of fire.</b>

#### Policy

All application for burning of road verges must be forwarded to the Shire in writing. Approval of burning of road verges to be given in writing by the Chief Executive Officer stipulating the following conditions.

- Burning of road verges is undertaken during Autumn;
- For a well conserved verge, burning should not be undertaken at a frequency less than 5 years and only when a sufficient hazard exists;
- For a partially degraded verge, the condition of the verge must constitute a fire hazard and positive protection given to areas of natural vegetation;
- For a degraded verge, burning may be undertaken with no restriction except for protection of isolated native vegetation; and
- The applicant whose property abuts the road verge shall be responsible for arranging the Bush Fire Brigades within the area to carry out the burn and ensuring that the burn does not extend beyond his frontage without his neighbours approval.

Areas of dispute are to be referred to Council for investigation and recommendation.

## 5.4 Harvest and Vehicle Movement Bans

<b>Policy Type:</b>	Fire Control
<b>Date Adopted:</b>	September 2014

<b>Policy No:</b>	<b>FC004</b>
<b>Date Last Reviewed:</b>	25 October 2022

<b>Legal (Parent):</b>
1. Bush Fires Act 1954

<b>Legal (Subsidiary):</b>
1.

ADOPTED POLICY	
<b>Title:</b>	<b>HARVEST BANS</b>
<b>Objective:</b>	<b>To identify who may call a Harvest Ban to reduce the risk of fire in the Shire of Beverley.</b>

### Policy

Harvest Ban Officers (Chief Fire Control Officer, Chief Executive Officer and Fire Weather Officers) are authorised to issue and advise, as required, any harvest and vehicle movement bans, the ban must be authorised by two of the listed officers. The SMS Service will be issued in the first instance by the Community Emergency Services Manager, followed by the Customer Service Officer or Chief Fire Control Officer in the CESM's absence.

Harvest Bans are to be advised to the public via the Harvest Ban Hotline, the Shire of Beverley SMS service and the ABC radio. Lifting of the ban must also be advised via the Harvest Ban Hotline and SMS service.

Policy Amended: 25 October 2016  
 Policy Amended: 26 September 2017

## 5.5 Annual Harvest Bans on Public Holidays

<b>Policy Type:</b>	Fire Control
<b>Date Adopted:</b>	September 2014

<b>Policy No:</b>	<b>FC005</b>
<b>Date Last Reviewed:</b>	25 October 2022

<b>Legal (Parent):</b>
1.

<b>Legal (Subsidiary):</b>
1.

ADOPTED POLICY	
<b>Title:</b>	<b>ANNUAL HARVEST BANS ON PUBLIC HOLIDAYS</b>
<b>Objective:</b>	<b>To control the risk of fire.</b>

### Policy

That it be notified for public information that harvesting is banned in the Shire of Beverley on Christmas Day, Boxing Day and New Year's Day every year.

## 5.6 Harvesting Operations – Fire Fighting Equipment

<b>Policy Type:</b>	Fire Control
<b>Date Adopted:</b>	September 2014

<b>Policy No:</b>	<b>FC006</b>
<b>Date Last Reviewed:</b>	25 October 2022

<b>Legal (Parent):</b>
1. Bush Fires Act 1954

<b>Legal (Subsidiary):</b>
1.

<b>ADOPTED POLICY</b>	
<b>Title:</b>	<b>HARVESTING OPERATIONS – FIRE FIGHTING EQUIPMENT</b>
<b>Objective:</b>	<b>To control the risk of fire within the Shire of Beverley.</b>

### Policy

That during any period when harvesting operations are being conducted, provided in the same paddock or within one hundred metres of that paddock, is an operational fire-fighting unit having a water capacity of not less than 600 litres. Trailer fire-fighting units with at least the same quantity of water are to be attached to a tractor or motor vehicle. The tank on the unit is to be kept full at all times during harvesting operations.

Policy Amended: 25 July 2017

## 5.7 Fire Fighting Attire

<b>Policy Type:</b>	Fire Control
<b>Date Adopted:</b>	September 2014

<b>Policy No:</b>	<b>FC007</b>
<b>Date Last Reviewed:</b>	25 October 2022

<b>Legal (Parent):</b>
<ol style="list-style-type: none"> <li>1. Bush Fires Act 1954</li> <li>2. Fire Brigades Act 1942</li> </ol>

<b>Legal (Subsidiary):</b>
<ol style="list-style-type: none"> <li>1.</li> </ol>

ADOPTED POLICY	
<b>Title:</b>	<b>FIRE FIGHTING ATTIRE</b>
<b>Objective:</b>	<b>To reduce the risk of injury when fighting fires.</b>

### Policy

The person in charge of fire-fighting operations is to order away those not wearing adequate and appropriate attire, including footwear.



## 5.8 Motor Vehicles – Fire Extinguisher

<b>Policy Type:</b>	Fire Control
<b>Date Adopted:</b>	September 2014

<b>Policy No:</b>	<b>FC008</b>
<b>Date Last Reviewed:</b>	25 October 2022

<b>Legal (Parent):</b>
1. Bush Fires Act 1954

<b>Legal (Subsidiary):</b>
1.

ADOPTED POLICY	
<b>Title:</b>	<b>MOTOR VEHICLES – FIRE EXTINGUISHER</b>
<b>Objective:</b>	<b>To reduce the risk of paddock fires in the Shire of Beverley.</b>

### Policy

A person cannot operate or suffer the operation of a motor vehicle with a load capacity of two tonnes or more within paddocks, during the prohibited burning period, unless a fire extinguisher is prescribed in Regulation 3 of the Bush Fires Act is provided on the vehicle.

“SUFFER” Landowner or occupier will be responsible to ensure that “contractors” etc. comply. It will be the owner/occupier committing an offence and NOT the contractors, once the owner/occupier becomes aware.

Fire Extinguisher as prescribed in Regulation 3 – means a device which comprises

- A container filled with at least 7.5 litres of water; and
- A pump capable of discharging that water, which is in a sound and efficient condition.

## 5.9 Council Policy – Vehicles Attending Fires

<b>Policy Type:</b>	Fire Control
<b>Date Adopted:</b>	September 2014

<b>Policy No:</b>	<b>FC009</b>
<b>Date Last Reviewed:</b>	25 October 2022

<b>Legal (Parent):</b>
1.

<b>Legal (Subsidiary):</b>
1.

ADOPTED POLICY	
<b>Title:</b>	<b>VEHICLES ATTENDING FIRES</b>
<b>Objective:</b>	<b>To reduce the risk of accidents when attending fires.</b>

### Policy

All vehicles attending fires are to be in a road worthy condition.

## 5.10 Plant Usage Authority – Bush Fires

<b>Policy Type:</b>	Fire Control
<b>Date Adopted:</b>	September 2014

<b>Policy No:</b>	<b>FC010</b>
<b>Date Last Reviewed:</b>	25 October 2022

<b>Legal (Parent):</b>
1.

<b>Legal (Subsidiary):</b>
1.

<b>ADOPTED POLICY</b>	
<b>Title:</b>	<b>PLANT USAGE AUTHORITY – BUSH FIRES</b>
<b>Objective:</b>	<b>To reduce the spread of fires by supplying further equipment.</b>

### Policy

In the event of a bushfire, the Chief Executive Officer, Deputy Chief Executive Officer or Manager of Works have the authority to direct Council plant to be used in a fire fighting capacity.

## 5.11 Approval of Fire Control Officers

<b>Policy Type:</b>	Fire Control
<b>Date Adopted:</b>	September 2014

<b>Policy No:</b>	<b>FC011</b>
<b>Date Last Reviewed:</b>	25 October 2022

<b>Legal (Parent):</b>
1. Bush Fires Act 1954

<b>Legal (Subsidiary):</b>
1.

<b>ADOPTED POLICY</b>	
<b>Title:</b>	<b>APPROVAL OF FIRE CONTROL OFFICERS</b>
<b>Objective:</b>	<b>To control the appointment of Fire Control Officers</b>

### Policy

Council is to ratify all appointments of officers appointed under the authority of the Bush Fires Act 1954 at the Annual Fire Control Officers meeting, at the next Ordinary Council Meeting.

## 5.12 Dual Registration of Fire Control Officers

<b>Policy Type:</b>	Fire Control
<b>Date Adopted:</b>	September 2014

<b>Policy No:</b>	<b>FC012</b>
<b>Date Last Reviewed:</b>	25 October 2022

<b>Legal (Parent):</b>
1. Bush Fires Act 1954

<b>Legal (Subsidiary):</b>
1.

ADOPTED POLICY	
<b>Title:</b>	<b>DUAL REGISTRATION OF FIRE CONTROL OFFICERS</b>
<b>Objective:</b>	<b>To legally recognise adjoining Shires Fire Control Officers.</b>

### Policy

That the Fire Control Officers in charge of Bushfire Brigade areas that adjoin the Shires of York, Quairading and Brookton be gazetted as Fire Control Officers with those Councils. The Shire of Beverley is to advise the Shires of York, Quairading and Brookton of the names of appropriate officers that will be required for gazettal.

The Shire of Beverley gazette the appropriate Fire Control Officers from the Shires of York, Quairading and Brookton for their areas

## 5.13 Bush Fire Incident Reports

<b>Policy Type:</b>	Fire Control
<b>Date Adopted:</b>	September 2014

<b>Policy No:</b>	<b>FC013</b>
<b>Date Last Reviewed:</b>	25 October 2022

<b>Legal (Parent):</b>
1. Bush Fires Act 1954

<b>Legal (Subsidiary):</b>
1.

<b>ADOPTED POLICY</b>	
<b>Title:</b>	<b>BUSH FIRE INCIDENT REPORTS</b>
<b>Objective:</b>	<b>To comply with reporting procedures of the Bush Fires Act 1954.</b>

### Policy

The appropriate Fire Control Officer is to submit written reports of any fires occurring in his area to the Shire as soon as possible after the fire. A copy of the report is to be forwarded to the Department of Fire and Emergency Services.

## 5.14 Fire Control Officer Annual and General Meetings

<b>Policy Type:</b>	Fire Control
<b>Date Adopted:</b>	September 2014

<b>Policy No:</b>	<b>FC014</b>
<b>Date Last Reviewed:</b>	25 October 2022

<b>Legal (Parent):</b> 1. Fire Brigades Act 1942
-----------------------------------------------------

<b>Legal (Subsidiary):</b> 1.
----------------------------------

<b>ADOPTED POLICY</b>	
<b>Title:</b>	<b>FIRE CONTROL OFFICER ANNUAL AND ORDINARY MEETINGS</b>
<b>Objective:</b>	<b>To establish the control of meetings.</b>

### Policy

The Fire Control Officer of each ward can call their own Brigade Meeting.

The Community Emergency Services Manager in consultation with the Chief Fire Control Officer will call general meetings. Members of Council, all Fire Control Officers and Brigade Captains are to be invited to attend.

Policy Amended: 26 October 2016

## 5.15 Emergency SMS Announcements

<b>Policy Type:</b>	Fire Control
<b>Date Adopted:</b>	25 July 2017

<b>Policy No:</b>	<b>FC015</b>
<b>Date Last Reviewed:</b>	25 October 2022

<b>Legal (Parent):</b>
1.

<b>Legal (Subsidiary):</b>
1.

ADOPTED POLICY	
<b>Title:</b>	<b>EMERGENCY SMS ANNOUNCEMENTS</b>
<b>Objective:</b>	<b>To control the nature and cost of SMS announcements</b>

### Policy

No SMS message is to be sent from the Shire of Beverley's SMS account before it has been discussed with the Shire's Community Emergency Services Manager and/or the Chief Executive Officer or Deputy Chief Executive Officer.

Where time and circumstance permit the Chief Bush Fire Control Officer should be informed and consulted.



## 6. *General*

### 6.1 Citizenship Ceremonies

<b>Policy Type:</b>	General
<b>Date Adopted:</b>	September 2014

<b>Policy No:</b>	<b>G001</b>
<b>Date Last Reviewed:</b>	25 October 2022

<b>Legal (Parent):</b>
1. Australian Ceremonies Code

<b>Legal (Subsidiary):</b>
1.

ADOPTED POLICY	
<b>Title:</b>	<b>CITIZENSHIP CEREMONIES</b>
<b>Objective:</b>	<b>To provide guidelines for planning and preparing Citizenship Ceremonies.</b>

#### Policy

The Shire of Beverley is required to hold a minimum of two citizenship ceremonies per calendar year, with one in each half of the year.

The Shire President is to conduct citizenship ceremonies. In the absence of the Shire President, the Deputy President may conduct the ceremony.

The Shire President or Deputy Shire President may not preside over a ceremony for a person who is a relative or close friend.

The formalities for the ceremony are to include the reading of the preamble, oath (Pledge of Commitment), the Minister's message, the vote registering and playing of the national anthem. The order will be determined by the Australian Citizenship Ceremonies Code.

The dress code for the Ceremony is formal, business or smart casual attire. Conferees are welcome to wear traditional, national or cultural dress

An invitation must be sent to all government representatives from all three levels of government to Australian Citizenship ceremonies. The Federal Minister for Immigration and Citizenship must be invited to all citizenship ceremonies.

Suitable refreshments can be provided for the ceremony. The signed Conferral Report is to be emailed to the Department of Immigration and Border Protection immediately following the ceremony (within 24hrs).

Policy Amended: 26 September 2017

Policy Amended: 27 August 2019

Policy Amended: 22 September 2020

Policy Amended: 25 October 2022

## **7. Planning**

Please refer to the Shire of Beverley Town Planning Scheme Policy Manual for the following Planning Policies:

- Street Trees and Streetscapes Policy
- Car Parking Requirements – Policy No. 3
- Development of Industrial Zoned Land
- Outbuildings Policy
- Relocated Second-Hand Buildings Policy No. 10
- Shire of Beverley Town Planning Fees Policy
- Tree Crops Policy
- Anglo Estate Policy
- Signage Policy
- Developer Contributions for Road and Footpath Upgrading
- Stocking Rates Policy

## 8. *Record Keeping*

### 8.1 Records Management

<b>Policy Type:</b>	Record Keeping
<b>Date Adopted:</b>	September 2014

<b>Policy No:</b>	<b>RK001</b>
<b>Date Last Reviewed:</b>	25 October 2022

<b>Legal (Parent):</b>
1. State Records Act 2000

<b>Legal (Subsidiary):</b>
1.

ADOPTED POLICY	
<b>Title:</b>	<b>RECORDS MANAGEMENT</b>
<b>Objective:</b>	<b>To ensure recordkeeping meets the State Records Act 2000.</b>

#### Policy

The Deputy Chief Executive Officer is responsible for amending the current Shire of Beverley Record Keeping Plan as it becomes due. The Record Keeping Plan will meet the standards set in the State Records Act 2000.

The Shire of Beverley Record Keeping Plan includes: Mail Management, Document Management, File Management, Information Access, Monitoring, Retention and Disposal, Archiving and Records training. Please refer to the Shire of Beverley Record Keeping Plan for relevant procedures.

Amended: 23 May 2017

Amended: 23 November 2021

## 9. Staff

### 9.1 Equal Employment Opportunity

<b>Policy Type:</b>	Staff
<b>Date Adopted:</b>	September 2014

<b>Policy No:</b>	<b>S001</b>
<b>Date Last Reviewed:</b>	25 October 2022

<b>Legal (Parent):</b>
1. Equal Opportunity Act 1984

<b>Legal (Subsidiary):</b>
1.

ADOPTED POLICY	
<b>Title:</b>	<b>EQUAL OPPORTUNITY</b>
<b>Objective:</b>	<b>To provide a workplace in which all persons can be treated with consideration and courtesy, in an environment free from discrimination and harassment.</b>

#### Policy

##### **Equal Opportunity Policy Statement**

The Shire of Beverley recognises its legal obligations under the *Equal Opportunity Act 1984* and will promote equal employment opportunity based solely on merit to ensure that discrimination does not occur on the grounds of gender, marital status, pregnancy, race, disability, religious or political convictions.

All offers of employment, employment training and promotional practices with this Council will be directed towards providing equal opportunity to all employees provided their relevant experience, skills and ability to meet the minimum requirements.

This Council will not tolerate harassment within its workplace. Harassment is defined as any unwelcome, offensive action or remark concerning a person's race, language, ethnicity, political or religious convictions, gender, marital status or disability.

#### **1. Responsible Officer**

The Chief Executive Officer is the Officer delegated to be responsible for implementing the Equal Opportunity Policy and objectives adopted by the Council.

#### **2. Awareness**

Upon appointment and at least once annually, all employees are to be given a full copy of this section of the Policy & Procedures Manual, and advised of amendments after adoption by Council.

### 3. Current Practices

Personnel practices are to be periodically reviewed in accordance with the Equal Employment Opportunity Policy, with particular consideration of practices and policies by designated staff covering:

- a) Recruitment,
- b) Conditions of Service,
- c) Appointment, Promotion and Transfer,
- d) Training and Development.

### 4. Personnel

The Chief Executive Officer is to ensure:

- a) That all advertisements, job descriptions and titles are non-discriminatory, and that all practices are fair and do not contain any discriminatory requirements or conditions.
- b) Subject to Policy (Appointment of Staff), that the most suitable person is appointed to a position. The appointment is to be based on qualifications, skills, expertise, experience and aptitude.
- c) That all personnel forms are non-discriminatory and relevant in phrasing and requirements.
- d) That benefits and entitlements are consistent throughout the workforce.

### 5. Internal Grievances - Initial Steps

- a) Assure complainant that confidentiality will be maintained and further procedures will only be undertaken with the complainant's consent.
- b) Clarify with the complainant the facts of the matter in so far as they can be established without further investigation.
- c) Take brief but accurate notes using the complainant's own words where possible. Check all details with the complainant.
- d) Clarify the options available to the complainant and the actions which the complainant or grievance officer could take eg
  - i) The complainant could make it clear to the other party that their behaviour is unwelcome and request that it cease,
  - ii) The complainant could contact their Union or the Equal Opportunity Commission;
  - iii) The grievance officer could proceed with an investigation of the complaint.

### 6. Internal Grievances - Investigation

If the complainant wishes to proceed, the investigation should be informal and flexible. All persons have the right to a fair hearing conducted in a non-accusative and non-judgmental manner.

- a) Interview in an impartial manner, the employee(s) against whom to allegations have been made.
- b) State exactly what it is they are accused of doing.
- c) Provide the opportunity for the person(s) to respond fully to the allegations.
- d) Interview any witnesses to the incident or incidents under investigation.
- e) Check the work record of the complainant to see if any alleged employment disadvantages are evident.
- f) Make it clear to all people involved in the investigation that it is unlawful to victimise another person in relation to the complaint and that any alleged occurrence of victimisation should be immediately referred to the Chief Executive Officer.

### 7. Internal Grievances - Resolution

If the grievance is not substantiated (eg no evidence to support the complaint or the conduct does not amount to discrimination under the *Equal Opportunity Act 1984*), both parties are to be advised of the result. The complainant should be told again of their right to take the complaint to their union or the Equal Opportunity Commission if they are not satisfied.

If the grievance is substantiated, tell both parties of this conclusion and the reasons for it. Immediate and appropriate steps to prevent the behaviour from recurring are to be taken. In most cases, it should be sufficient to counsel the employee or employees concerned and exercise close supervision in the work area.

## 9.2 Industrial Representation

<b>Policy Type:</b>	Staff
<b>Date Adopted:</b>	September 2014

<b>Policy No:</b>	<b>S002</b>
<b>Date Last Reviewed:</b>	25 October 2022

<b>Legal (Parent):</b>
1.

<b>Legal (Subsidiary):</b>
1.

<b>ADOPTED POLICY</b>	
<b>Title:</b>	<b>INDUSTRIAL REPRESENTATION</b>
<b>Objective:</b>	<b>To appoint an Industrial Advocate.</b>

### Policy

In industrial disputes, the Shire of Beverley's interests are to be represented by its appointed Industrial Advocate.

The Chief Executive Officer is given standing authority to authorise Council's appointed industrial service to act for the Shire of Beverley in any particular industrial dispute, provided that should the Chief Executive Officer not be satisfied that the Shire of Beverley's appointed industrial service's proposed actions are in the Shire of Beverley's interest, the matter is referred to the next Ordinary Council meeting.

### 9.3 Senior Staff Designation & Appointment

<b>Policy Type:</b>	Staff
<b>Date Adopted:</b>	September 2014

<b>Policy No:</b>	<b>S003</b>
<b>Date Last Reviewed:</b>	25 October 2022

<b>Legal (Parent):</b>
1. Local Government Act 1995

<b>Legal (Subsidiary):</b>
1.

ADOPTED POLICY	
<b>Title:</b>	<b>DESIGNATED SENIOR STAFF</b>
<b>Objective:</b>	<b>To designate Senior Staff.</b>

#### Policy

The following positions are designated as senior staff for the purposes of Section 5.37(1) of the *Local Government Act 1995*:

Deputy Chief Executive Officer  
 Manager of Works  
 Building Surveyor  
 Environmental Health Officer  
 Manager of Planning and Development

Policy Amended: 26 September 2017

## 9.4 Corporate Uniform, Dress Code and Hygiene at Work

<b>Policy Type:</b>	Staff
<b>Date Adopted:</b>	September 2014

<b>Policy No:</b>	<b>S004</b>
<b>Date Last Reviewed:</b>	25 October 2022

<b>Legal (Parent):</b>
1.

<b>Legal (Subsidiary):</b>
1.

ADOPTED POLICY	
<b>Title:</b>	<b>CORPORATE UNIFORM, DRESS CODE &amp; HYGIENE AT WORK</b>
<b>Objective:</b>	<b>To provide parameters regarding appropriate types of clothing , standards of dress and related matters.</b>

### **Policy**

The Shire of Beverley is committed to presenting itself in a professional manner as well as maintaining a safe and healthy working environment for its employees.

Unless as specifically authorised by the Chief Executive Officer, or as negotiated in a salary package, the Shire of Beverley will provide administrative employees with a subsidised corporate uniform.

1. Full-time Administration staff will be provided with subsidised uniforms to the value of \$450 per annum from the Local Government Corporate Collection. Full Time Equivalent (FTE) Administration staff will be provided with subsidised uniforms to the full-time pro-rata value per annum from the Local Government Corporate Collection.
2. Staff are entitled to the uniform subsidy after a qualifying period of three months.
3. Unused uniform subsidy may not be accrued.
4. Staff leaving Council's employ within three months of receiving the subsidy are required to repay 50% and those that leave between three and six months after receiving the subsidy, 25% of Council's contribution.

Primarily uniforms are to be worn during working hours and employees should take care to refrain from wearing uniforms outside of work. Employees must recognise that when wearing the uniform they are recognised as representing Local Government.

Employees who choose not to use the subsidised corporate uniform must present for work in a professional manner and be suitably attired for their work activities. The standard for both men and women is smart business dress. Smart business dress for work does not include; low cut or sheer tops, tops that expose the midriff, shorts that expose the buttocks, thongs, ugg boots, slippers, bare feet, singlets, frayed jeans or board shorts.

The following items may be acceptable providing they are not offensive in nature, they do not pose any possible hazard to health and safety at work or deviate significantly from the image required given the work area; clothing worn to comply with cultural or religious practices; tattoos or body piercings; and jewellery.

An employee's hair should be neat and tidy and kept in a clean condition.

Policy Amended: 25 October 2016



## 9.5 Personal Protective Equipment

<b>Policy Type:</b>	Staff
<b>Date Adopted:</b>	September 2014

<b>Policy No:</b>	<b>S005</b>
<b>Date Last Reviewed:</b>	25 October 2022

<b>Legal (Parent):</b>
1.

<b>Legal (Subsidiary):</b>
1. Work Health & Safety (General) Regs 2022

<b>ADOPTED POLICY</b>	
<b>Title:</b>	<b>PERSONAL PROTECTIVE EQUIPMENT</b>
<b>Objective:</b>	<b>To ensure outside staff are protected while completing their work duties.</b>

### Policy

Staff are to be issued with personal protective clothing and equipment appropriate to their duties.

1. Personal Protective clothing issues may include the following:
  - (a) Annually – work clothing, safety boots or shoes (to \$450 per employee); and
  - (b) As necessary – sunscreen, water bottles, safety vests and wet weather gear.
2. Staff leaving Council's employ within three months of receiving the subsidy are required to repay 50% and those that leave between three and six months after receiving the subsidy, 25% of Council's contribution.
3. Primarily uniforms are to be worn during working hours and employees should take care to refrain from wearing uniforms outside of work. Employees must recognise that when wearing the uniform they are recognised as representing Local Government.

Policy Amended: 27 August 2019  
 Policy Amended: 25 October 2022

## 9.6 Gratuity Payments to Employees

<b>Policy Type:</b>	Staff
<b>Date Adopted:</b>	September 2014

<b>Policy No:</b>	<b>S006</b>
<b>Date Last Reviewed:</b>	25 October 2022

<b>Legal (Parent):</b>
1.

<b>Legal (Subsidiary):</b>
1.

<b>ADOPTED POLICY</b>	
<b>Title:</b>	<b>GRATUITY PAYMENTS TO EMPLOYEES</b>
<b>Objective:</b>	<b>To determine an appropriate value of gift and function to an employee terminating their employment at the Shire of Beverley.</b>

### Policy

That Council present a gift to staff upon termination (with the CEO's discretion of up to the value set out in Table 1.1), and also provide light refreshments and drinks (up to the value set out in Table 1.2) where appropriate.

Table 1.1 – Gift

<i>Years of Service</i>	<i>Council Contribution</i>
0 to 3 Years	Up to \$200
3 to 5 Years	Up to \$350
5 to 10 Years	Up to \$450
10 to 15 Years	Up to \$550
15 to 20 Years	Up to \$650
20 to 25 Years	Up to \$750
<i>For Each Year of Service thereafter: \$35</i>	

Table 1.2 – Function

<i>Years of Service</i>	<i>Council Contribution</i>
0, =2 Years	Up to \$100
>2, =5 Years	Up to \$250
>5, =10 Years	Up to \$350
>10, =15 Years	Up to \$450
>15 Years and Over	Up to \$550

Policy Amended: 28 November 2017

## 9.7 Injury Management and Rehabilitation

<b>Policy Type:</b>	Staff
<b>Date First Adopted:</b>	September 2014

<b>Policy No:</b>	<b>S007</b>
<b>Date Last Reviewed:</b>	25 October 2022

<b>Legal (Parent):</b>
1. Work Health & Safety Act 2020

<b>Legal (Subsidiary):</b>
1. Workers Compensation and Injury Management Act 1981

ADOPTED POLICY	
<b>Title:</b>	<b>INJURY MANAGEMENT AND REHABILITATION</b>
<b>Objective:</b>	<b>To comply with the Work Health &amp; Safety Act 2020 &amp; Workers Compensation and Injury Management Act 1981 in relation to work related injury and rehabilitation.</b>

### POLICY SCOPE

This policy applies to all Shire of Beverley workers who sustain injury, illness or disability during direct work-related activities.

### POLICY STATEMENT

It is the policy of the Shire of Beverley:

- a) To make provision for the injury management and rehabilitation of all workers who have sustained a compensable work-related illness, injury or disability.
- b) To treat all workers with dignity and respect.
- c) To guarantee that all information is treated with sensitivity and confidentiality.
- d) To return the injured worker to the fullest capacity for gainful employment of which they are capable.

The 'Key Principles of Injury Management', as identified by WorkCover, will be adopted.

They are:

1. Recognition that employers and injured workers are the primary stakeholders within the workers' compensation system.
2. Maintenance in or a safe return to work is the expected outcome.
3. Medical practitioners and employers play a central decision-making role in the return to work of injured workers.
4. The focus of all services should be workplace based.
5. The injury management process should be transparent, cost effective and efficient.
6. Early intervention and pro-active injury management is critical in achieving return to work goals.
7. When vocational rehabilitation is required, all parties are involved in a process that is transparent and requires joint decision making.

Policy Amended: 25 October 2022

## 9.8 Noise

<b>Policy Type:</b>	Staff
<b>Date Adopted:</b>	September 2014

<b>Policy No:</b>	<b>S008</b>
<b>Date Last Reviewed:</b>	25 October 2022

<b>Legal (Parent):</b>
1. Work Health & Safety Act 2020

<b>Legal (Subsidiary):</b>
1. Work Health & Safety (General) Regs 2022

ADOPTED POLICY	
<b>Title:</b>	<b>NOISE POLICY</b>
<b>Objective:</b>	<b>To ensure the hearing safety of Shire of Beverley employees.</b>

### Policy

The Shire of Beverley is committed to identifying and reducing all noise hazards in the workplace. The Organisation will, so far as is practicable, ensure that noise to which a person is exposed at the workplace does not exceed the exposure standard for noise Work Health and Safety Regulations (general) 56 namely an exposure equivalent to 85 dB(A) for 8 hours a day or a peak noise of 140 dB(C). If there is an exposure to machinery and equipment over 85dB(A) there shall be a regularly updated and maintained "Noise Exposure (Machinery and Equipment) Register".

It is mandatory to refer to the "Noise Procedure" for the Management of noise in the workplace.

It is mandatory that everyone exposed to high noise levels at the workplace shall have a base line hearing test at time of employment and annual testing thereafter, and recorded on their personnel file, which is stored in a secured location.

Policy Amended: 25 October 2022

## 9.9 Work Health & Safety

<b>Policy Type:</b>	Staff
<b>Date Adopted:</b>	September 2014

<b>Policy No:</b>	<b>S009</b>
<b>Date Last Reviewed:</b>	25 October 2022

<b>Legal (Parent):</b>
1. Occupational Health & Safety Act 1984

<b>Legal (Subsidiary):</b>
1.

ADOPTED POLICY	
<b>Title:</b>	<b>WORK HEALTH &amp; SAFETY</b>
<b>Objective:</b>	<b>To promote the sound and effective Work Health and Safety practices as a common objective for the Chief Executive Officer, Senior Staff, Employees and Contractors.</b>

### Policy Objective

To confirm the Shire of Beverley commitment to and outline the principles regarding the management of Work Health and Safety in the workplace.

### Policy Scope

This policy applies to all elected members, employees, volunteers and contractors of the Shire of Beverley.

### Policy Statement

We at the Shire of Beverley believe that the safety, health and well-being of all people employed by us, or people affected by our work, is a priority and must be considered during all work performed by us or on our behalf.

### Objectives

The objectives of this policy are to, as far as reasonably practicable:

- Achieve a safe and incident free workplace.
- Provide adequate training, instruction and supervision to enable employees to perform their work safely and effectively.
- Involve employees and subcontractors in the decision-making process through regular communication and consultation.
- Ensure employees and contractors identify and control risks when in the workplace.
- Consider Work Health and Safety in project planning and work activities.

The success of our Work Health and Safety performance depends on:

- The commitment of all persons
- Allocation of resources and achieving the policy objectives.
- Planning work activities with due consideration given to Work Health and Safety.
- Undertaking the risk management process in an effective manner.
- Communicating and consulting with our employees and contractors.

We are committed to fulfilling the objectives of this policy and expect the same of all employees and contractors working on our behalf.

<b>Chief Executive Officer</b>	<b>Work Health &amp; Safety Officer</b>	<b>Shire President</b>	<b>Action</b>
<i>Stephen Gollan</i>	<i>Ashleigh Fleay</i>	<i>David White</i>	<i>Reviewed, Amended &amp; Adopted October 22</i>

#### Previous Actions

<b>Stephen P Gollan</b>	<b>Valery J Seeber</b>	<b>Denise J Ridgway</b>	<b>Action</b>
<u>Chief Executive Officer</u>	<u>Occupational Health and Safety Officer</u>	<u>Council President</u>	
16 December 2014	16 December 2014	16 December 2014	Amended & Adopted
27 October 2015	27 October 2015	27 October 2015	Reviewed & Adopted
25 October 2016	25 October 2016	25 October 2016	Reviewed & Adopted
26 September 2017	26 September 2017	26 September 2017	Reviewed & Adopted
23 October 2018	23 October 2018	23 October 2018	Reviewed & Adopted
27 August 2019	27 August 2019	27 August 2019	Reviewed & Adopted
<b>Stephen Gollan</b>	<b>Ashleigh Waight</b>	<b>Don Davis</b>	<b>Action</b>
<u>Chief Executive Officer</u>	<u>Occupational Health and Safety Officer</u>	<u>Council President</u>	
22 September 2020	22 September 2020	22 September 2020	Reviewed, Amended & Adopted.
Stephen Gollan	Ashleigh Waight	David White – President	
23 November 2021	23 November 2021	23 November 2021	Reviewed and Adopted

## 9.10 Discrimination, Harassment and Bullying Policy

<b>Policy Type:</b>	Staff
<b>Date Adopted:</b>	23 February 2016

<b>Policy No:</b>	<b>S010</b>
<b>Date Last Reviewed:</b>	25 October 2022

<b>Legal (Parent):</b>
1. Fair Work Act 2009

<b>Legal (Subsidiary):</b>
1.

ADOPTED POLICY	
<b>Title:</b>	<b>DISCRIMINATION, HARASSMENT AND BULLYING POLICY</b>
<b>Objective:</b>	<b>To assist the Shire of Beverley to be an environment that is free from discrimination, harassment and bullying.</b>

### Policy

#### Policy Statement

The **Shire of Beverley** and its employees are committed to providing a working environment where every employee is treated equally, fairly and without prejudice. For the purposes of this policy, the term “employee/s” will extend to cover contractors, volunteers and any person performing work for or with the **Shire of Beverley** in any capacity.

#### ***Unlawful Discrimination***

The **Shire of Beverley** acknowledges its responsibilities and obligations pursuant to State and Federal equal opportunity and anti-discrimination laws.

The **Shire of Beverley** and its employees acknowledge they are subject to State and Federal equal opportunity and anti-discrimination legislation. The following is a non-exhaustive list of the grounds of discrimination for which it is unlawful to discriminate against an individual:

- Age;
- Family responsibility or status;
- Race or colour;
- Sex including gender identity, sexual orientation and intersex status;
- Physical or mental disability;
- Marital status;
- Political or religious conviction;
- Pregnancy;
- Criminal record;
- Breastfeeding;
- Gender history;
- Impairment;
- National extraction or social origin; and
- Trade union activity

**Sexual Harassment**

The *Equal Opportunity Act 1984 (WA)* and the *Sex Discrimination Act 1984 (Cth)* provide that it is unlawful to engage in sexual harassment. Sexual harassment can be defined as any unwelcome conduct of a sexual nature, such as an unwelcome sexual advance or an unwelcome request for sexual favours, in circumstances in which a reasonable person would anticipate that the person harassed would be offended, humiliated or intimidated.

**Some examples of sexual harassment include, but are not limited to:**

- Physical contact (touching, rubbing, patting, embracing, brushing up against etc.);
- Gestures of a sexual nature;
- Leering or staring;
- Offensive telephone calls, emails, text messages or notes;
- Sexual suggestive jokes or comments;
- Tales of sexual exploits;
- Repeated requests for a date;
- Unwelcome comments or questions about a person's sex life, appearance or dress; and
- Sexually graphic material (poster, calendars, cartoons, graffiti, messages, emails).

**Bullying**

Bullying is defined as repeated and unreasonable behaviour directed towards an employee or a group of employees that creates a risk to health and safety. Unreasonable behaviour amounts to behaviour that a reasonable person in the circumstances would see as unreasonable including behaviour that is victimising, humiliating, intimidating or threatening.

Bullying is also unlawful under the *Occupational Safety and Health Act 1984 (WA)* and the *Occupational Safety and Health Regulations 1996 (WA)*.

**Some examples of bullying include, but are not limited to:**

- Loud, abusive or offensive language or comments;
- Yelling and screaming;
- Unjustified criticism and insults;
- Unjustified threats of dismissal or other disciplinary action;
- Acts of sabotaging another's work by withholding information which is required to fulfil tasks;
- Spreading malicious rumours or misinformation;
- Inappropriate comments about an employee's appearance, lifestyle or family;
- Deliberately excluding an employee from workplace meetings or activities;
- Hiding documents or equipment or withholding vital information required for effective work performance;
- Constantly changing targets or work guidelines;
- Overloading an employee with work and impossible deadlines;
- Setting tasks that are unreasonably below or beyond an employee's level of skill;
- Threats of assault or violence or actual violence;
- Teasing and practical jokes; and
- Isolating or ignoring an employee on a constant basis.

Where an employee makes a threat of violence or assaults another employee, the police should be called.

**Reasonable Management Action**

The **Shire of Beverley** has a right to take reasonable management action to direct the way in which work is conducted and to give employees lawful and reasonable directions to complete work in a certain manner. Reasonable management action is not workplace bullying.

**Some examples of reasonable management action include, but are not limited to:**

- The establishment and regular use of performance management systems;
- The setting of reasonable performance targets and deadlines;
- Providing employees with constructive feedback or counselling to assist workers to improve their work performance or the standard of their behaviour;
- Issuing a lawful and reasonable direction to an employee to complete a work task;



- Preparing and amending a roster for employees;
- Transferring an employee to a different work location for operational reasons;
- Implementing organisational change;
- Informing an employee about inappropriate behaviour in a confidential manner; and
- Taking disciplinary action against an employee.

#### ***Other Behaviours not Considered to be Bullying***

Where two or more employees have a difference of opinion and disagree on an issue, this is not usually considered to be workplace bullying. However, where conflict escalates and is repeated, it may meet the definition of workplace bullying.

Additionally, bullying does not occur where bullying behaviour is a one off occurrence and if that behaviour does not create a risk to health or safety,

#### ***What are the Ways in which Bullying can Occur?***

There are a variety of ways bullying behaviour can occur in the workplace such as verbally, through email or text message or via social media. Bullying can be directed at an individual employee or a group of employees, and can be carried out by one or more employees. Bullying can occur between employees, downwards from managers to employees or upwards from employees to supervisors or managers.

#### ***What to do if you think you are being Discriminated Against, Sexually Harassed or Bullied?***

Refer to the Grievance Policy and Grievance Procedure for steps to take if you think you are being discriminated against, sexually harassed or bullied, or if you suspect another employee is experiencing any of those things.

#### ***Roles & Responsibilities***

To ensure the intent of this policy is realised, various roles within the **Shire of Beverley** must assume certain responsibilities.

##### ***The Employer***

The **Shire of Beverley** will endeavour to:

- provide all workplace participants with a workplace free from discrimination, sexual harassment and bullying;
- provide and maintain safe systems of work;
- provide a fair and effective procedure to investigate and resolve complaints of sexual harassment, discrimination and bullying;
- treat all employees fairly; and
- take suitable disciplinary action against any employee who is found to have sexually harassed, discriminated, bullied or victimised another employee.

##### ***All the Organisation's Employees***

Employees are required to:

- report any incidents of sexual harassment, discrimination or bullying they may see happening around them to an appropriate manager or supervisor;
- follow all policies and procedures of the **Shire of Beverley**;
- ensure they do not victimise any person making a complaint of sexual harassment, discrimination or bullying; and
- treat all employees fairly and with respect.

##### ***Support***

The **Shire of Beverley** engages the services of an external Employee Assistance Provider who can provide employees with confidential counselling. Please see the Human Resources Officer for details of the Employee Assistance Provider.

##### ***Consequences of Breaching This Policy***

Any breach of this policy, may result in disciplinary action up to and including termination of employment.

## 9.11 Training and Development

<b>Policy Type:</b>	Staff
<b>Date Adopted:</b>	September 2014

<b>Policy No:</b>	<b>S011</b>
<b>Date Last Reviewed:</b>	25 October 2022

<b>Legal (Parent):</b>
1.

<b>Legal (Subsidiary):</b>
1.

<b>ADOPTED POLICY</b>	
<b>Title:</b>	<b>TRAINING AND DEVELOPMENT</b>
<b>Objective:</b>	<b>To invest in the ongoing development of Staff.</b>

### Policy

People are the major asset of the Shire of Beverley and the Training and Development Policy aims to invest in the ongoing development of staff.

The Shire of Beverley Training Policy is guided on following principles:

- You have a major role in determining your specific training and development needs
- A performance review system operates to ensure your training and development needs are discussed annually to ensure your skills are kept up to date.

Induction:

As a new employee you will be taken through an induction to introduce you to the structure of the Shire of Beverley, where you sit within it and take you through all the basic things you need to know about life in your new position.

Performance Appraisal

Each employee will have an annual performance appraisal review, completed by the Chief Executive Officer, Deputy Chief Executive Officer or the Manager of Works. The purpose of this appraisal is to: evaluate job performance; review your job description; and identify areas of training.

Identifying areas of training is to either build on your strengths or to cover those elements of your job that you may have limited experience. The training needs will be put in writing and will form the basis of your individual training plan for the period until your next review.

The Shire of Beverley is committed to creating a “learning culture”. The Shire of Beverley will continue to succeed because we recognise that the business environment is constantly changing and that we need to acquire knowledge and expertise to keep us ahead of the game.

Professional/Vocational Qualifications:

The Shire of Beverley recognises that there are many professional skills required to ensure that the Shire of Beverley is successful. Graduate and professional qualifications in such areas as Occupational Health and Safety, Risk Management, Accountancy, Information Technology and Human Resources are valued.

Subject to prior agreement with Chief Executive Officer, the fees for relevant professional education may be met or subsidised by the Shire of Beverley.

**Proviso:**

Reimbursement of fees for non-obligatory courses is by negotiation with the Chief Executive Officer. You will be asked to sign an undertaking to repay fees should you leave within 12 months, including giving the Shire of Beverley the right to deduct such monies from final salary and outstanding holiday pay.

**Professional and Representative Bodies:**

If the Chief Executive Officer is a member of an appropriate professional body which is recognised by the Shire of Beverley, the subscription fee will be reimbursed.

## 9.12 Chief Executive Officer Annual Performance Review

<b>Policy Type:</b>	Staff
<b>Date Adopted:</b>	September 2014

<b>Policy No:</b>	<b>S012</b>
<b>Date Last Reviewed:</b>	25 October 2022

<b>Legal (Parent):</b>
1. Local Government Act 1995

<b>Legal (Subsidiary):</b>
1. Local Government Administration Regulations

<b>ADOPTED POLICY</b>	
<b>Title:</b>	<b>CHIEF EXECUTIVE OFFICER ANNUAL PERFORMANCE REVIEW</b>
<b>Objective:</b>	<b>To ensure ongoing evaluation and performance of the Chief Executive Officer.</b>

### Policy

At least once annually the performance of the Chief Executive Officer is to be reviewed by the President and Councillors.

Prior to the review, all Councillors and the Chief Executive Officer are to complete the performance indicators sheet.

The review is to be conducted in a manner described in the relevant Contract of Employment. The review should be conducted annually at a time of mutual benefit. Council have the power to amend his/her salary package.

When considering the CEO salary, Council must consider the Determination of the Salaries and Allowances Tribunal with written explanatory justification as part of the decision being given in the Meeting Minutes to the Community for Council decisions that exceed the Determination of the Tribunal.

Council is then required to formally accept the review at the next Ordinary Council Meeting (Regulation 18D – *Local Government Administration Regulations*).

Policy Amended: 23 October 2018  
Policy Amended: 23 February 2021

### 9.13 Staff Annual Performance Review

<b>Policy Type:</b>	Staff
<b>Date Adopted:</b>	September 2014

<b>Policy No:</b>	<b>S013</b>
<b>Date Last Reviewed:</b>	25 October 2022

<b>Legal (Parent):</b>
1.

<b>Legal (Subsidiary):</b>
1.

ADOPTED POLICY	
<b>Title:</b>	STAFF ANNUAL PERFORMANCE REVIEW
<b>Objective:</b>	To ensure staff performance is regularly monitored.

#### Policy

The Chief Executive Officer is to ensure that performance and salary (package – if applicable) reviews are conducted for all staff and has the power to amend salary packages.

Reviews to be conducted annually in April or May prior to the budget meeting.

Policy Amended: 25 October 2016

## 9.14 Council Vehicles

<b>Policy Type:</b>	Staff
<b>Date Adopted:</b>	September 2014

<b>Policy No:</b>	<b>S014</b>
<b>Date Last Reviewed:</b>	25 October 2022

<b>Legal (Parent):</b>
1.

<b>Legal (Subsidiary):</b>
1.

<b>ADOPTED POLICY</b>	
<b>Title:</b>	<b>COUNCIL VEHICLES</b>
<b>Objective:</b>	<b>To identify who in the organisation can use Shire vehicles for private use.</b>

### Policy

The Chief Executive Officer, the Deputy Chief Executive Officer, Manager of Works and the Community Emergency Services Manager will be granted private use of the Shire cars BE 1, BEV 0, BE 022 and BE 000 respectively.

Shire workers (inside and outside staff) are given approval to drive Shire vehicles including BE 1 and BEV 0 when available for work purposes.

Policy Amended: 23 November 2021

## 9.15 Staff Housing Policy

<b>Policy Type:</b>	Staff
<b>Date Adopted:</b>	September 2014

<b>Policy No:</b>	<b>S015</b>
<b>Date Last Reviewed:</b>	25 October 2022

<b>Legal (Parent):</b>
1. Residential Tenancies Act 1987 (WA)

<b>Legal (Subsidiary):</b>
1.

ADOPTED POLICY	
<b>Title:</b>	<b>STAFF HOUSING</b>
<b>Objective:</b>	<b>To ensure that eligible Council employees are provided with suitable housing of a good standard and that housing is managed appropriately.</b>

### Policy

In order to attract qualified personnel to the Shire of Beverley, selected staff may be offered subsidised housing by Council.

### **Eligibility**

The Chief Executive Officer can determine which employees are eligible for a Council provided house and associated allowances as part of their employment package/contract. The Chief Executive Officer is to confirm that the position attracts housing and associated benefits prior to the position being advertised.

### **Tenancy Agreement**

Employees provided with housing are required to sign a Tenancy Agreement. All clauses of the Tenancy Agreement must be complied with or housing may be revoked.

### **Inspections**

Regular inspections of all council owned property will be carried out by a representative of Council.

Council's houses shall be inspected as outlined below:

1. Initial inspection upon occupation by the tenant.
2. Inspection three months thereafter.
3. If the three month inspection reveals that the house is being well maintained, then the next inspection will be the annual inspection in February for maintenance purposes.
4. If the three month inspection reveals that the house is not being well maintained, then the next inspection will be in another three months.
5. Final inspection on termination of employment.

An inspection report shall be completed during the inspection and is to be signed by both the tenant and the Council representative carrying out the inspection.

## 9.16 No Smoking Policy

<b>Policy Type:</b>	Staff
<b>Date Adopted:</b>	September 2014

<b>Policy No:</b>	<b>S016</b>
<b>Date Last Reviewed:</b>	25 October 2022

<b>Legal (Parent):</b>
1. Occupational Health and Safety Act 1984

<b>Legal (Subsidiary):</b>
1.

ADOPTED POLICY	
<b>Title:</b>	<b>SMOKING POLICY</b>
<b>Objective:</b>	<b>To raise the awareness that smoking is harmful to health, and to comply with legislated smoking bans.</b>

### Policy

Section 19 of the Occupational Safety and Health Act 1984 requires an employer, so far as practicable, to provide and maintain a working environment in which the employees are not exposed to hazards. Because of the acknowledged health hazards of exposure to RTS, and to comply with the legal obligations, the Shire of Beverley has adopted a smoke-free workplace policy that formalises its commitment, and extends beyond the legislated smoking bans.

Smoking is prohibited in all indoor areas and within 5 metres of any entrance workplace owned or leased by the Shire of Beverley, and is restricted to designated outdoor areas. Smoking is prohibited in all vehicles owned or leased by the Shire of Beverley.

Shire of Beverley staff members are not permitted to smoke when they are acting in an official capacity off-site.

The Shire of Beverley smoke-free policy applies to all persons including staff and visitors to the workplace.



### 9.17 Organisational Chart

<b>Policy Type:</b>	Staff
<b>Date Adopted:</b>	September 2014

<b>Policy No:</b>	<b>S017</b>
<b>Date Last Reviewed:</b>	25 October 2022

<b>Legal (Parent):</b>	1.
------------------------	----

<b>Legal (Subsidiary):</b>	1.
----------------------------	----

**ADOPTED POLICY**

<b>Title:</b>	<b>ORGANISATIONAL CHART</b>
<b>Objective:</b>	<b>To outline the organisational structure of the Shire of Beverley.</b>

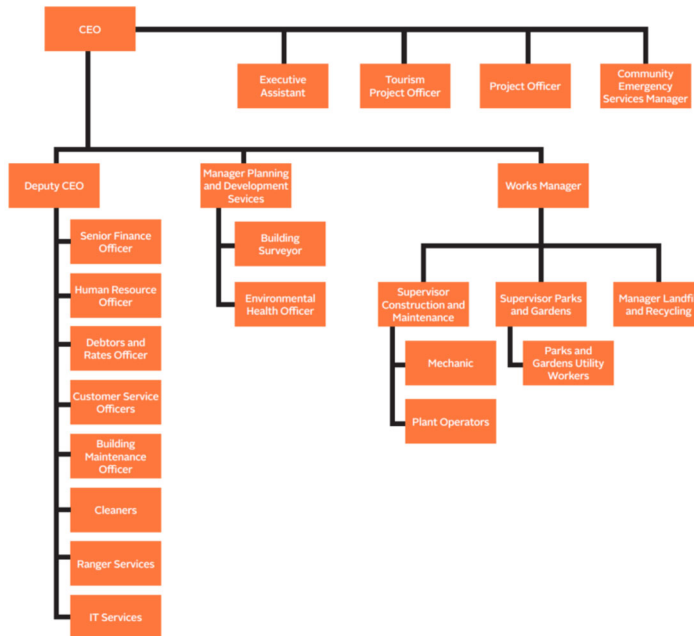

- Policy Amended: 25 October 2016
- Policy Amended: 23 October 2018
- Policy Amended: 27 August 2019
- Policy Amended: 22 September 2020
- Policy Amended: 23 November 2021

## 9.19 Staff Use of Shire Equipment

<b>Policy Type:</b>	Staff
<b>Date Adopted:</b>	September 2014

<b>Policy No:</b>	<b>S019</b>
<b>Date Last Reviewed:</b>	25 October 2022

<b>Legal (Parent):</b>
1.

<b>Legal (Subsidiary):</b>
1.

ADOPTED POLICY	
<b>Title:</b>	<b>STAFF USE OF SHIRE EQUIPMENT</b>
<b>Objective:</b>	<b>To provide guidance for the use of Council Plant and Equipment by Shire Staff.</b>

### Policy:

Employees are permitted to use Council plant and equipment at their place of residence within the Shire of Beverley, subject to the following terms;

1. Employees are to complete a "Plant/Equipment Use Request Form" and return to the Manager of Works for authorisation a minimum of three (3) working days prior to the use date.
2. Plant or equipment to be used on weekends or at times when it is convenient to the Shire and does not affect its normal operations.
3. Plant items are to be operated by a Shire Employee who is suitably qualified in the correct use of that item of plant or equipment.
4. All plant and equipment is to leave the Depot full with fuel. Upon return the plant or equipment is to be refuelled with Shire fuel only and the total litres used recorded in the Fuel Register, with PRIVATE STAFF USE clearly written next to the entry. In addition, if applicable, the plant or equipment is to be washed down and greased so as not to impinge the next User.
5. The employee will be charge at a rate of \$2.50 per litre for the amount of fuel used.
6. Any damage to the plant (including tyres, mirrors, windows etc) is to be reported to the Manager of Works upon return and repair costs are to be charged to the User. If damage is claimable under the Shires insurance policy, then the excess is payable by the User.
7. Plant and equipment is to be used on the User's own private property only.
8. The intent of the above policy is that employees are not using the equipment for their own private commercial business.
9. Plant usage in relation to the maintenance of Council owned property will not incur the \$2.50 per litre fuel charge.
10. Animals are not permitted inside Shire plant or equipment without prior permission from the Manager of Works.

Policy Amended: 25 October 2016

Policy Suspended: 26 November 2016

Policy Reviewed and Remained Suspended: 23 May 2017

Policy Amended and Suspension Lifted: 27 August 2019

## 9.20 Master Keys

<b>Policy Type:</b>	Staff
<b>Date Adopted:</b>	September 2014

<b>Policy No:</b>	<b>S020</b>
<b>Date Last Reviewed:</b>	25 October 2022

<b>Legal (Parent):</b>
1.

<b>Legal (Subsidiary):</b>
1.

<b>ADOPTED POLICY</b>	
<b>Title:</b>	<b>MASTER KEY POLICY</b>
<b>Objective:</b>	<b>To outline the distribution of keys to access Council owned buildings and structures.</b>

### **Policy:**

Council staff, depending on their role, are issued with keys allowing varying degrees of accessibility to Council owned buildings and structures.

Where practical, Council owned buildings have been fitted with locks on a master key system. This allows master key holders with efficient and quick access to any building particularly in the event of an emergency.

A register of all keys and their holders is to be maintained by the Deputy Chief Executive Officer and updated as appropriate.

Accessibility is to be reviewed from time to time to ensure access to buildings is in line with the best interests of Council operations.

The creation of any new keys is to be authorised by the Chief Executive Officer, or in their absence, the Deputy Chief Executive Officer.

## 9.21 Grievance, Investigations and Resolutions Policy

<b>Policy Type:</b>	Staff
<b>Date Adopted:</b>	23 February 2016

<b>Policy No:</b>	<b>S021</b>
<b>Date Last Reviewed:</b>	25 October 2022

<b>Legal (Parent):</b>
1. Fair Work Act 2009

<b>Legal (Subsidiary):</b>
1.

ADOPTED POLICY	
<b>Title:</b>	<b>GRIEVANCE, INVESTIGATIONS AND RESOLUTIONS POLICY</b>
<b>Objective:</b>	<b>To guide staff in the grievance investigation and resolution process.</b>

### Policy

#### **Policy Statement**

All employees have a right to express any genuine grievances or complaints via an impartial internal process. All employees involved in a grievance process are expected to participate in good faith. For the purposes of this policy, the term “employee/s” will extend to cover contractors, volunteers and any person performing work for or with the **Shire of Beverley** in any capacity.

#### **Roles**

**Complainant** – An employee who raises a complaint about a matter regarding the workplace.

**Respondent** – An employee who is alleged to have acted in a manner which caused the complainant to raise a complaint.

**Support Person** – A Complainant and/or a Respondent may choose to bring a Support Person with them to a meeting, where practicable. The role of a Support Person is not to advocate on behalf of anyone, but to simply provide emotional support.

**Witness** – A person (including an employee) who is requested by the Local Government to assist the process by providing relevant information regarding the complaint.

#### ***What to do if you have a Complaint?***

If an employee (Complainant) is the victim of behaviour of another employee (Respondent) which is inconsistent with the Local Government’s policies, procedures or guidelines (Policies), the Complainant should, where reasonable or practicable, first approach the Respondent for an informal discussion. If the nature of the complaint is deemed to be sufficiently serious, the complainant should contact their Manager directly.

If the inappropriate behaviour continues, the Complainant is encouraged to make a formal complaint to their direct manager. If the direct manager is the Respondent in the matter or if the employee feels uncomfortable approaching their manager, the Complainant should approach the Deputy Chief Executive Officer.

The employee who receives the complaint must contact their Manager and decide upon the most appropriate way to take the matter forward, whether it is an informal discussion with the Complainant and/or the Respondent, or the commencement of a formal investigation of the complaint.

### ***Key Principles in the Complaint Resolution Process***

The following principles are necessary for the fair investigation and resolution of a complaint:

**Confidential** – Only the employees directly investigating or addressing the complaint will have access to the information about the complaint. The **Shire of Beverley** may inform or appoint a third party to investigate or advise on the investigation. All parties involved in dealing with a complaint are required to keep the matter confidential. Information will only be placed on an employee's personal file if they are disciplined as a result of the complaint;

**Impartial (fair/unbiased)** – Both parties will have an opportunity to put their case forward. No assumptions are made and no action will be taken until available and relevant information has been collected and considered;

**Sensitive** – The employees who assist in responding to complaints should be specifically trained or equipped to treat all complaints sensitively and ensure the process is free of coercion or intimidation;

**Timely** – The **Shire of Beverley** aims to deal with all complaints as quickly as possible and in accordance with any legislative requirements;

**Documented** – All complaints and investigations must be documented. In formal grievance processes, records must be kept of all documents collected and/or drafted as part of that process. For more informal processes, a file note or note in a diary may be sufficient;

**Natural Justice** – The principles of natural justice provide that:

A Respondent against whom allegations are made as part of a grievance process has the right to respond to the allegations before any determination is made;

### ***Key Principles in the Complaint Resolution Process (Continued):***

- A Respondent against whom an allegation is made has the right to be told (where possible and appropriate) who made the allegation;
- anyone involved in the investigation should be unbiased and declare any conflict of interest;
- decisions must be based on objective considerations and substantiated facts; and
- the Complainant and the Respondent have the right to have a support person present at any meetings where practicable.

**Procedural Fairness** – The principles of procedural fairness provide that:

- the Respondent is advised of the details (as precisely and specifically as possible) of any allegations when reasonably practicable;
- A Respondent is entitled to receive verbal or written communication from the **Shire of Beverley** of the potential consequences of given forms of conduct, as applicable to the situation;
- The Respondent is given an opportunity to respond to any allegations made against them by a Complainant;
- Any mitigating circumstances presented to the **Shire of Beverley** through the grievance process are investigated and considered;
- the Respondent has the right to have an appropriate support person present during any inquiry or investigation process where practicable or necessary;
- any witnesses who can reasonably be expected to help with any inquiry or investigation process should be interviewed; and
- All interviews of witnesses are conducted separately and confidentially.

### ***Outcome of Making a Complaint***

If a complaint is substantiated, there are a number of possible outcomes. If the complaint involves a performance issue, the manager of the Respondent may:

- commence a formal or informal performance management process with the Respondent or elect to discipline the Respondent.
- If the complaint involves a breach of a Policy or any other behaviour that is inconsistent with the employment relationship, the manager of the Respondent, in consultation with the Chief Executive Officer, may elect to discipline the Respondent in accordance with the Disciplinary Policy.

### ***Vexatious or Malicious Complaints***

Where a Complainant has deliberately made a vexatious or malicious complaint, that Complainant may be subject to disciplinary action, including but not limited to, termination of employment.

### ***Victimisation of Complainant***

A Complainant must not be victimised by the Respondent or any other employee of the **Shire of Beverley** for making a complaint. Anyone responsible for victimising a Complainant may be subject to disciplinary action, including but not limited to, termination of employment.

### ***Variation to This Policy***

This policy may be cancelled or varied from time to time. All the **Shire of Beverley's** employees will be notified of any variation to this policy by the normal correspondence method.

### ***Related Corporate Documents:***

Discrimination, Harassment, & Bullying Policy  
Code of Conduct  
EEO Policy

## 9.22 Rostered Days Off

<b>Policy Type:</b>	Staff
<b>Date Adopted:</b>	April 2016

<b>Policy No:</b>	<b>S022</b>
<b>Date Last Reviewed:</b>	25 October 2022

<b>Legal (Parent):</b>
1. Local Government Industry Award 2010

<b>Legal (Subsidiary):</b>
1.

ADOPTED POLICY	
<b>Title:</b>	<b>ROSTERED DAYS OFF</b>
<b>Objective:</b>	<b>Outline the criteria for awarding Rostered Days Off to Staff and setting limits on the accumulation of Rostered Days Off.</b>

### Policy

Rostered Days Off have been incorporated to encourage a healthy work-life balance for Shire of Beverley Staff and allow time to conduct personal business and appointments.

Full Time Employees employed under the Local Government Industry Award 2010 and National Employment Standards are entitled to one Rostered Day Off (RDO) per fortnight commencing from employment.

RDO days can be taken on any day Monday to Friday, however the same day is to be taken per RDO (e.g. if Monday is selected as the RDO day by the employee, each RDO must be taken on a Monday).

The day on which a particular RDO is taken is flexible upon negotiation between the Staff member and their direct supervisor. However, the swapping of RDO days should be limited to reduce disruption to planned work activities.

If an RDO falls on a public holiday, the RDO is to be taken on the next working day.

A maximum of two (2) RDOs are to be accumulated at any time, unless otherwise approved by the Chief Executive Officer.

Any RDOs accumulated over the two day limit will be forfeited.

Accumulated RDOs will not be paid out.

## 9.23 Service Pay Allowance

<b>Policy Type:</b>	Staff
<b>Date Adopted:</b>	August 2016

<b>Policy No:</b>	<b>S023</b>
<b>Date Last Reviewed:</b>	25 October 2022

<b>Legal (Parent):</b>
1.

<b>Legal (Subsidiary):</b>
1.

ADOPTED POLICY	
<b>Title:</b>	<b>SERVICE PAY</b>
<b>Objective:</b>	<b>In recognition of Years of Service with the Shire of Beverley</b>

### Policy

That the following Service Pay Allowances, as set out below, are paid to all current and future employees with the exception of employees designated in Policy S003

SP01	After 1 completed year of service	\$11.00 per fortnight or pro-rata if part-time employee
SP02	After 2 completed years of service	\$16.00 per fortnight or pro-rata if part-time employee
SP03	After 3 completed years of service	\$21.00 per fortnight or pro-rata if part-time employee
SP05	After 5 completed years of service	\$25.00 per fortnight or pro-rata if part-time employee
SP07	After 7 completed years of service	\$29.00 per fortnight or pro-rata if part-time employee
SP10	After 10 completed years of service	\$33.00 per fortnight or pro-rata if part-time employee

The Service Pay Allowance is to be reviewed annually.



## 9.24 Grave Digging Allowance

<b>Policy Type:</b>	Staff
<b>Date Adopted:</b>	August 2016

<b>Policy No:</b>	<b>S024</b>
<b>Date Last Reviewed:</b>	25 October 2022

<b>Legal (Parent):</b>
1.

<b>Legal (Subsidiary):</b>
1.

ADOPTED POLICY	
<b>Title:</b>	<b>GRAVE DIGGING ALLOWANCE</b>
<b>Objective:</b>	<b>Establish an additional allowance for Grave Digging.</b>

### Policy

That an employee who digs or assists with digging a grave will be paid an additional \$50.00 per grave.

That an employee who re-opens or assists with the re-opening of a grave for another burial will be paid an additional \$100.00 per re-opening of a grave.

## 9.25 Communications Policy

<b>Policy Type:</b>	Staff
<b>Date Adopted:</b>	December 2016

<b>Policy No:</b>	<b>S025</b>
<b>Date Last Reviewed:</b>	25 October 2022

<b>Legal (Parent):</b>
1.

<b>Legal (Subsidiary):</b>
1.

ADOPTED POLICY	
<b>Title:</b>	COMMUNICATIONS POLICY
<b>Objective:</b>	This policy establishes protocols for the Shire of Beverley's official communications with all stakeholders to ensure that all forms of communication and correspondence are responded to in a timely manner

### Policy

This policy applies to:

2. Communications between the Shire of Beverley and community;
3. Elected Members ("Councillors") in either their role as Councillor or in a personal capacity; and
4. Communications between Shire of Beverley Staff and Elected Members

### Policy Statement

#### 1. Official Communications

The purposes of the Shire of Beverley's official communications shall include not but limited to:

- Sharing information required by law to be publicly available;
- Sharing information that is of interest and benefit to the Community;
- Promoting Beverley's events and services;
- Promoting Public Notices and community consultation / engagement opportunities;
- Answering questions and responding to requests for information relevant to the role of the Shire of Beverley; and
- Receiving and responding to community feedback, ideas, comments, compliments and complaints.

The Shire of Beverley's official communications will be consistent with relevant legislation, policies, standards and the positions adopted by the Council. Our communications will always be respectful, professional, and timely.

The Shire of Beverley will use a combination of different communication modes to suit the type of information to be communicated to meet the requirements of the community or specific audience, including:

- Website;
- Advertising and promotional materials;
- Media releases prepared for the Shire President, to promote specific Shire of Beverley positions;
- Social media; and

- Community newsletters, letter drops and other modes of communications undertaken by the Shire of Beverley's Administration at the discretion of the CEO.

## **2. Speaking on behalf of the Shire of Beverley**

The Shire President is the official spokesperson for the Shire of Beverley and may represent the Shire of Beverley in official communications including; speeches, comment, print, electronic and social media. [ s.2.8(1)(d) of the Local Government Act 1995]

Where the Shire President is unavailable, the Deputy Shire President may act as the spokesperson. [s.2.9 and s.5.34 of the Local Government Act 1995]

The CEO may speak on behalf of the Shire of Beverley, where authorised to do so by the Shire President. [s.5.41(f) of the Local Government Act 1995]

The CEO may speak in relation to operational matters of the Shire of Beverley.

Councillors shall not undertake any unauthorised communication by any means, including use of social media, on behalf of the Shire of Beverley and neither shall they present their personal views so as to imply these views represent the official view of the Shire of Beverley.

Councillors must be authorised by either the President or Deputy President (where the President is unavailable) before communicating in an official capacity and such communications must comply with the code of conduct and the *Local Government (Rules of Conduct) Regulations 2007*.

Social media accounts or unsecured website forums must not be used to transact meetings which relate to the official business of the Shire of Beverley.

## **3. Written Correspondence**

All external written correspondence (including electronic mail and facsimiles) will receive a written acknowledgement within fourteen (14) working days of receipt.

External correspondence that is marked as a copy and addressed to a third party will not be acknowledged unless, in the opinion of the CEO or D/CEO a response is appropriate.

The CEO, D/CEO and Managers shall determine which items of correspondence will be presented to Council, through the appropriate means. All correspondence addressed to Council or Councillors will be presented to Council.

### **3.1 Presidential Correspondence**

Presidential correspondence will be issued on Shire of Beverley letterhead, and a file copy be kept in the appropriate file(s) together with the originating correspondence.

All external correspondence addressed to the Shire President will be opened, date stamped, recorded and left in the Shire President's tray.

### **3.2 Councillor Correspondence**

All external correspondence addressed to Councillor will be opened, date stamped, recorded and left in the Executive Assistant's tray to distribute.

### **3.3 Stationery**

The Shire's stationery and equipment, including letterhead and envelopes are not to be used by Councillors or those seeking election for election purposes.

## **4. Responding to Media Enquiries**

In accordance with the Local Government Act 1995 and Shire of Beverley Policy EM003, all media contact and communication will be conducted or approved by the Shire President.

## **5. Website**

The Shire of Beverley will maintain an official website as a means of communication.

**6. Record Keeping and Freedom of Information**

Publications produced by the Shire will be available for residents and ratepayers in the Beverley Library, the website and the administration office.

**7. Communication between Councillors and Staff**

Where a councillor has a minor query that can be satisfied by direct enquiry to the relevant staff member, the councillor may make such direct enquiry. Where the ~~the~~ matter of concern to the councillor is a matter of an operational or policy matter, the Councillor shall take the enquiry to the CEO or such person as delegated by the CEO and the CEO may request that the matter be put in writing and submitted to the CEO.

Staff will communicate to Council any projects or activities which have varied in the scope of works or budget from the original planning process.

Amended: 25 May 2019

## 9.26 Leave for Defence Forces Active Reservists

<b>Policy Type:</b>	Staff
<b>Date Adopted:</b>	March 2017

<b>Policy No:</b>	<b>S026</b>
<b>Date Last Reviewed:</b>	25 October 2022

<b>Legal (Parent):</b>
1. Defence Reserve Service (Protection) Act 2001

<b>Legal (Subsidiary):</b>
1.

ADOPTED POLICY	
<b>Title:</b>	<b>LEAVE FOR DEFENCE FORCES ACTIVE RESERVISTS</b>
<b>Objective:</b>	<b>To recognise the importance placed on reservists by allowing staff to attend training.</b>

### Policy

Unpaid leave, not exceeding 2 weeks, in any one year will be granted to employees who are members of the Defence Force Active Reserve for the purpose of undertaking training in camp or other continuous duty. This leave will be in addition to annual holiday leave.

If the pay received by the employee from the Defence Force is less than the employee would normally receive, the Shire will make up the balance.

Any time spent by an employee in Defence Force Reserve training will count towards the accrual of annual leave.

## 9.27 Drug & Alcohol Policy

<b>Policy Type:</b>	Staff
<b>Date Adopted:</b>	27 June 2017

<b>Policy No:</b>	<b>S027</b>
<b>Date Last Reviewed:</b>	25 October 2022

<b>Legal (Parent):</b>
1. Work Health & Safety Act 2020

<b>Legal (Subsidiary):</b>
1.

ADOPTED POLICY	
<b>Title:</b>	<b>DRUG AND ALCOHOL POLICY</b>
<b>Objective:</b>	<b>Random Drug and Alcohol Testing</b>

### Policy

#### **The Shire of Beverley's Commitment**

The Shire of Beverley and its employees must take all reasonable care not to endanger the safety of themselves or others (including customers) in the workplace. Alcohol and other drug usage is an occupational safety and health issue if a worker's ability to exercise judgment, coordination, motor control, concentration and alertness at the workplace is impaired. For the purposes of this policy, the term "employee/s" shall extend to cover contractors, volunteers and any person performing work for or with the Shire of Beverley in any capacity.

#### **The Individual's Responsibility**

Under the *Work Health and Safety Act 2020* (the WHS Act), workers must take reasonable care of their own safety and health and not endanger the safety and health of others at the workplace. The consumption of alcohol and/or drugs while at work is unacceptable, except in relation to any authorised and responsible use of alcohol at workplace social functions. Employees are required to present themselves for work and remain, while at work, capable of performing their work duties safely. An employee who is under the influence of alcohol and/or drugs at the workplace, or is impaired, will face disciplinary action including termination of employment.

#### **Tolerance Level**

The Shire of Beverley has a '**zero**' tolerance on both Drug and Alcohol Consumption.

#### **Reporting Requirements**

Employees must report to their employer any situation where they genuinely believe that an employee may be affected by alcohol and/or other drugs.

#### **Drug Use on the Premises**

Employees who buy, take, or sell drugs on Shire of Beverley's premises, may be found to have engaged in serious misconduct. Such behaviour shall result in disciplinary action up to and including dismissal. Employees who have been prescribed medication/drugs by a medical practitioner that could interfere with their ability to safely carry out their role must inform their manager or Human Resources and disclose any side effects that these medication/drugs may cause.

### **Consumption of Alcohol on the Premises**

Except in situations where the Shire of Beverley holds a function on the premises and alcohol is provided, employees must not bring in and/or consume alcohol in the workplace.

### **Drug/Alcohol Treatment Programs**

Where an employee acknowledges that they have an alcohol or drug problem and are receiving help and treatment, the Local Government may provide assistance to the employee.

- The Local Government may allow an employee to access any accrued personal or annual leave while they are undergoing treatment. And;
- The Local Government will take steps to return an employee to their employment position after completion of the treatment program, if practicable in the circumstances.

Where an employee acknowledges that they have an alcohol or drug problem and are receiving help and treatment, the line manager or members of senior management, will review the full circumstances and agree on a course of action to be taken. This may include redeployment to suitable alternative employment, or possible termination from employment if the employee is unable to safely carry out the requirements of their role.

### **Managers' Responsibilities - Consumption of Alcohol at Work Sponsored Functions**

Team managers shall:

- encourage their people to make alternative arrangements for transport to and from work prior to the function;
- ensure that the following is made available: - Low alcohol beer, soft drinks and water - Beverages: Tea, Coffee and Food;
- if the manager believes a person may be over the BAC 0.05 limit, assist the person with safe transport home (including contacting a family member or arranging a taxi); and
- if the manager has to leave the function early, appoint a delegate to oversee the rest of the function.

### **Pre-Employment Medical Tests**

As part of the recruitment selection criteria, preferred candidates for employment positions may be required to attend a medical assessment which includes drug and alcohol testing.

### **Identification of Impairment and Testing**

If the Shire of Beverley has reasonable grounds to believe that an employee is affected by drugs and/or alcohol it will take steps to address the issue.

Reasonable grounds may include (but are not limited to), where an employee's coordination appears affected, has red or bloodshot eyes or dilated pupils, smells of alcohol, acts contrary to their normal behaviour, or otherwise appears to be affected by drugs and/or alcohol.

Random testing may also be conducted. Random testing may utilise a variety of methods for randomly selecting names such as software, lottery of selection through coloured marbles in a bag drawn by each employee. All staff on site must participate in the random selection.

If the Shire of Beverley suspects that an employee is under the influence of drugs and/or alcohol it may pursue any or all of the following actions:

- direct an employee to attend a medical practitioner and submit to a medical assessment to determine whether the employee is fit to safely perform their duties;
- require that an employee undergo drug and alcohol testing administered by a representative of the Shire of Beverley; and/or
- direct an employee to go home.

A medical assessment may include a drug and/or alcohol test. Testing shall be conducted in accordance with the Australian Standard AS/NZS 4760 - Procedures for specimen collection and the detection and quantitation of drugs in oral fluid and/or the Australian Standard AS/NZS 4308 - Procedures for specimen collection and the detection and quantitation of drugs of abuse in urine.

In circumstances where an employee indicates the consumption of prescription or pharmacy drugs, the Shire of Beverley can request further information from the medical practitioner conducting the assessment about the effects and proper usage of the prescription or pharmacy drugs being taken. The Shire of Beverley may direct the employee to go home following the medical assessment until it can be established that they are fit to undertake their duties.

If an employee refuses to attend a medical examination or refuses to submit to an alcohol or drug test, the employee will be immediately directed to go home. Refusal to attend a medical assessment or refusal to go home constitutes a breach of this policy and will result in disciplinary action being taken against the employee up to and including the termination of employment.

The following steps are to be taken where an employee who has submitted to a medical assessment returns a positive test result for alcohol and/or drugs:

- The employee tested and the supervisor (or respective employer) will be informed of the result;
- A disciplinary discussion will take place in accordance with the disciplinary policies and procedures of the Shire of Beverley.

An employee who returns a positive test will be in breach of this policy. A breach of this policy will result in disciplinary action being taken against the employee up to and including the termination of employment.

#### **Education, Training & Awareness**

Employees who recognise that they have a drink or drug problem, or that they are at risk of developing one, are encouraged to come forward so that they can be assisted to get the appropriate help.

#### **Consequences of Breaching this Policy**

An employee engaged by the Shire of Beverley who breaches the provisions of this policy will face disciplinary action including termination of employment.

#### **Variation to this Policy**

This policy may be cancelled or varied from time to time. All the organisation's employees will be notified of any variation to this policy by the normal correspondence method.

Amended: 24 April 2018

Amended: 25 October 2022



## 9.28 Social Media Policy

<b>Policy Type:</b>	Staff (and Community)
<b>Date Adopted:</b>	25 May 2019

<b>Policy No:</b>	<b>S028</b>
<b>Date Last Reviewed:</b>	25 October 2022

<b>Legal (Parent):</b>
1.

<b>Legal (Subsidiary):</b>
1.

ADOPTED POLICY	
<b>Title:</b>	<b>SOCIAL MEDIA POLICY</b>
<b>Objective:</b>	<b>To advise staff, councillors and community of the expected behaviour on all Shire of Beverley social media platforms, accounts and pages.</b>

### Policy

The Shire of Beverley encourages community discussion on its social media platforms however guidelines have been developed to ensure users are aware of expected behaviour on the social media platform.

The Shire does not accept responsibility for external comments on this page. They are not representative of the opinions or views of the Shire, nor does the Shire make any warranty to their accuracy.

Posts may be deleted as determined at the Shire's absolute discretion if they contain:

- violent, obscene, profane, hateful, derogatory, racist or sexist language links or images;
- information that may compromise the safety or security of the public;
- any discussion or promotion of behaviour that is unlawful;
- comments that threaten or defame any person or organisation;
- solicitations, advertisements, endorsements or spam;
- encouragement or glamorisation of the use of alcohol, tobacco, or illegal drugs;
- multiple successive off-topic posts by a single user;
- repetitive posts copied and pasted or duplicated by single or multiple users; and/or
- any other inappropriate content or comments as determined by the Shire of Beverley.

When interacting with this page, the Shire requests that you:

- exercise courtesy;
- do not post your personal address or phone number;
- acknowledge that the Shire cannot check the accuracy of every post and does not take any responsibility for reliance on posts on this page; and
- adhere to [Facebook Guidelines](#).

You enter into an agreement with the Shire of Beverley by 'liking' the Shire of Beverley Facebook page. Visitors to the page are considered a user of the page and so should conform to these guidelines. It is at the discretion of the Shire of Beverley to block any users that do not comply with these guidelines.

Contact the Shire of Beverley on (08) 96461200 or [admin@beverley.wa.gov.au](mailto:admin@beverley.wa.gov.au) for further enquiries.

<b>Social Media Protocol</b>
------------------------------

**Objective:**

This Protocol has been developed:

- To provide guidance to employees on the use of social media as representatives of the Shire of Beverley either at work or in a personal capacity;
- To ensure social media channels are used in an appropriate manner, consistent with business needs and best practice;
- To ensure the Shire of Beverley maximises the use of social media tools to inform and engage with stakeholders and the community; and
- To protect the Shire of Beverley's reputation.

**Scope**

This Protocol applies to all employees using social media sites. This Protocol does not apply to Elected Members.

**Definitions**

Social media tools are online platforms or sites which facilitate the building of social networks for the purpose of communicating, sharing news, comments and opinions. The business objective of social media tools is to converse and engage with stakeholders, customers and the community. The social media tools permitted are:

- Facebook
- Instagram
- Shire website.

**Management of Social Media Tools and Content**

The Chief Executive Officer will decide the extent of use of social media sites by employees.

For the purposes of record keeping requirements, postings on social media sites are managed in the same way as other forms of electronic communication. It is therefore the responsibility of the employee publishing or viewing information, videos, photos and the like to determine if the content constitutes a corporate record.

**Business Use of Social Media**

When preparing information for posting on social media sites, employees are expected to be aware of their responsibilities to:

- Ensure appropriate authorisations are obtained before providing any information for posting on social media sites;
- Ensure that any information posted online serves to enhance the services of the Shire, is in line with the Shire's mission and values, and will not bring the Shire into disrepute;
- Comply with Shire policies and protocols, in particular the Shire's Code of Conduct;
- Comply with all laws relating to copyright, recordkeeping, privacy and defamation, including the need for accurate information, maintaining reliable records of official use, and ensuring comments are free from discrimination and harassment;
- Cite all sources quoted within information posted;
- Ensure advice or comments posted relate to the officer's area of responsibility and ensure that appropriate approvals are obtained before publishing;
- Ensure all communication is objective and courteous;
- Ensure that the privacy and confidentiality of information acquired at work is protected at all times;
- Avoid making statements or engaging in activities of a party political nature; and
- Seek advice if unsure what is required.

Non compliance with Shire policies and protocols may result in the loss of access privileges or disciplinary action, and will be subject to the provisions of the Shire's Code of Conduct Policy and the Managing Employee Relations Issues or provisions of other relevant State or Commonwealth legislation.

**Personal Use of Social Media**

If identified as Shire employees on social media sites, employees are reminded of the need to ensure they do not bring themselves and/or the Shire into disrepute in their personal use of social media whether using personal computer equipment at home or at work. Where comments or personal profiles identify individuals as Shire of Beverley employees, it is necessary to:

- Avoid derogatory comments about the Shire of Beverley;
- Ensure that any personal comments are declared as personal comments and not official Shire statements;

- Ensure that all content published is accurate and not misleading, and complies with Shire policies and protocols;
- Ensure any photographs published are appropriate;
- Ensure that comments about fellow Shire employees cannot be regarded as harassing or discriminatory, or impact on workplace relationships;
- Disclose and discuss only publicly available information relating to the Shire; and
- Be polite and respectful to people whom the officer is communicating.

**Community Use of the Shire’s Social Media Sites**

Guidelines which determine appropriate conduct for community users of the Shire’s social media tools are to be made available on the relevant media sites. See the *Shire of Beverley Social Media Guidelines for Visitors and Users*.

**Promotion of Shire Programs, Services and Events**

1. Officers seek relevant approval from Managers to use social media tools for the promotion of programs, services and events as required.
2. Upload content to the respective social media sites.
3. Monitor social media platforms on a regular basis each day during business hours and after hours.

**Responding to Comments from the Public**

1. Assess whether a response is required to social media posts made by members of the public.
2. Draft a response to comments posted on the Shire’s social media sites and publishes the comment. If the content is considered to be contentious, refer the response to the relevant Managers, or the Chief Executive Officer for approval before publishing.
3. If community posts are deemed to be inappropriate or derogatory, respond to the comments, *advising that the item has been removed as it does not meet the Shire’s Social Media Guidelines for Community Users*.
4. If community posts are inaccurate, respond with accurate and relevant information to clarify the issue. If the content is considered to be contentious, refer the response to the relevant Managers, or the Chief Executive Officer for approval before publishing.

**Record Keeping Requirements**

Shire officers must store a copy of any information, videos, photos etc published by Shire employees or external users on social media platforms if the content published is deemed **a corporate record**, ie:

1. *It conveys information essential or relevant in making a decision.*
2. *It conveys information upon which others will be, or are likely to make decisions affecting the Shire’s operations, or rights and obligations under legislation.*
3. *It conveys information about matters of public safety or public interest, or involves information upon which contractual undertakings are entered into.*
4. *The information likely to be needed for future use, or is it of historical value or interest.*

If content is deemed to be a corporate record, a screen-dump of the content must be taken and stored to the recordkeeping system (TRIM). Requests for information or services made via social media sites must be forwarded to the Records Helpdesk for processing to the relevant Business Unit for a response.

**Effective Response for Negative Feedback**

*Reply-* in a timely manner

*Empathise*

*Apologise* – Whether or not the Shire’s fault, you are not apologising for a mistake but for the bad experience

*Offer resolution* – Never make a promise you cannot keep direct to the Shire office for further information

*Hide rather than delete* – *Deleting can be misinterpreted as censorship or deception.*

**Holding Statement examples for negative feedback**

***“Thankyou for bringing that to our attention, we have the relevant personnel looking into it and will post an update as soon as we can. Thank you for your patience.”***

***“We apologise for any inconvenience caused and appreciate your patience.”***

## 9.29 CEO Recruitment, Performance and Termination

<b>Policy Type:</b>	Staff
<b>Date Adopted:</b>	27 April 2021

<b>Policy No:</b>	<b>S012</b>
<b>Date Last Reviewed:</b>	25 October 2022

<b>Legal (Parent):</b>
1. Local Government Act 1995 – Section 5.39B

<b>Legal (Subsidiary):</b>
1.

ADOPTED POLICY	
<b>Title:</b>	<b>CEO RECRUITMENT, PERFORMANCE AND TERMINATION</b>
<b>Objective:</b>	<b>To ensure recruitment, performance and termination of the Chief Executive Officer meet the standards of the <i>Local Government Act 1995</i>.</b>

### Policy

#### Division 1 — Preliminary provisions

##### 1. Citation

These are the Shire of Beverley Standards for CEO Recruitment, Performance and Termination.

##### 2. Terms used

(1) In these standards —

**Act** means the Local Government Act 1995;

**additional performance criteria** means performance criteria agreed by the local government and the CEO under clause 16(1)(b);

**applicant** means a person who submits an application to the local government for the position of CEO;

**contract of employment** means the written contract, as referred to in section 5.39 of the Act, that governs the employment of the CEO;

**contractual performance criteria** means the performance criteria specified in the CEO's contract of employment as referred to in section 5.39(3)(b) of the Act;

**job description form** means the job description form for the position of CEO approved by the local government under clause 5(2);

**local government** means the Shire of Beverley;

**selection criteria** means the selection criteria for the position of CEO determined by the local government under clause 5(1) and set out in the job description form;

**selection panel** means the selection panel established by the local government under clause 8 for the employment of a person in the position of CEO.

- (2) Other terms used in these standards that are also used in the Act have the same meaning as they have in the Act, unless the contrary intention appears.

## **Division 2 — Standards for recruitment of CEOs**

### **3. Overview of Division**

This Division sets out standards to be observed by the local government in relation to the recruitment of CEOs.

### **4. Application of Division**

- (1) Except as provided in subclause (2), this Division applies to any recruitment and selection process carried out by the local government for the employment of a person in the position of CEO.
- (2) This Division does not apply —
- (a) if it is proposed that the position of CEO be filled by a person in a class prescribed for the purposes of section 5.36(5A) of the Act; or
  - (b) in relation to a renewal of the CEO's contract of employment, except in the circumstances referred to in clause 13(2).

### **5. Determination of selection criteria and approval of job description form**

- (1) The local government must determine the selection criteria for the position of CEO, based on the local government's consideration of the knowledge, experience, qualifications and skills necessary to effectively perform the duties and responsibilities of the position of CEO of the local government.
- (2) The local government must, by resolution of an absolute majority of the council, approve a job description form for the position of CEO which sets out —
- (a) the duties and responsibilities of the position; and
  - (b) the selection criteria for the position determined in accordance with subclause (1).

### **6. Advertising requirements**

- (1) If the position of CEO is vacant, the local government must ensure it complies with section 5.36(4) of the Act and the *Local Government (Administration) Regulations 1996* regulation 18A.
- (2) If clause 13 applies, the local government must advertise the position of CEO in the manner referred to in the *Local Government (Administration) Regulations 1996* regulation 18A as if the position was vacant.

### **7. Job description form to be made available by local government**

If a person requests the local government to provide to the person a copy of the job description form, the local government must —

- (a) inform the person of the website address referred to in the *Local Government (Administration) Regulations 1996* regulation 18A(2)(da); or
- (b) if the person advises the local government that the person is unable to access that website address —
  - (i) email a copy of the job description form to an email address provided by the person; or
  - (ii) mail a copy of the job description form to a postal address provided by the person.

### **8. Establishment of selection panel for employment of CEO**

- (1) In this clause —

***independent person*** means a person other than any of the following —

- (a) a council member;
  - (b) an employee of the local government;
  - (c) a human resources consultant engaged by the local government.
- (2) The local government must establish a selection panel to conduct the recruitment and selection process for the employment of a person in the position of CEO.
- (3) The selection panel must comprise —
- (a) council members (the number of which must be determined by the local government); and
  - (b) at least 1 independent person.

**9. Recommendation by selection panel**

- (1) Each applicant's knowledge, experience, qualifications and skills must be assessed against the selection criteria by or on behalf of the selection panel.
- (2) Following the assessment referred to in subclause (1), the selection panel must provide to the local government —
- (a) a summary of the selection panel's assessment of each applicant; and
  - (b) unless subclause (3) applies, the selection panel's recommendation as to which applicant or applicants are suitable to be employed in the position of CEO.
- (3) If the selection panel considers that none of the applicants are suitable to be employed in the position of CEO, the selection panel must recommend to the local government —
- (a) that a new recruitment and selection process for the position be carried out in accordance with these standards; and
  - (b) the changes (if any) that the selection panel considers should be made to the duties and responsibilities of the position or the selection criteria.
- (4) The selection panel must act under subclauses (1), (2) and (3) —
- (a) in an impartial and transparent manner; and
  - (b) in accordance with the principles set out in section 5.40 of the Act.
- (5) The selection panel must not recommend an applicant to the local government under subclause (2)(b) unless the selection panel has —
- (a) assessed the applicant as having demonstrated that the applicant's knowledge, experience, qualifications and skills meet the selection criteria; and
  - (b) verified any academic, or other tertiary level, qualifications the applicant claims to hold; and
  - (c) whether by contacting referees provided by the applicant or making any other inquiries the selection panel considers appropriate, verified the applicant's character, work history, skills, performance and any other claims made by the applicant.
- (6) The local government must have regard to, but is not bound to accept, a recommendation made by the selection panel under this clause.

**10. Application of cl. 5 where new process carried out**

- (1) This clause applies if the local government accepts a recommendation by the selection panel under clause 9(3)(a) that a new recruitment and selection process for the position of CEO be carried out in accordance with these standards.
- (2) Unless the local government considers that changes should be made to the duties and responsibilities of the position or the selection criteria —
  - (a) clause 5 does not apply to the new recruitment and selection process; and
  - (b) the job description form previously approved by the local government under clause 5(2) is the job description form for the purposes of the new recruitment and selection process.

**11. Offer of employment in position of CEO**

Before making an applicant an offer of employment in the position of CEO, the local government must, by resolution of an absolute majority of the council, approve —

- (a) the making of the offer of employment to the applicant; and
- (b) the proposed terms of the contract of employment to be entered into by the local government and the applicant.

**12. Variations to proposed terms of contract of employment**

- (1) This clause applies if an applicant who is made an offer of employment in the position of CEO under clause 11 negotiates with the local government a contract of employment (the negotiated contract) containing terms different to the proposed terms approved by the local government under clause 11(b).
- (2) Before entering into the negotiated contract with the applicant, the local government must, by resolution of an absolute majority of the council, approve the terms of the negotiated contract.

**13. Recruitment to be undertaken on expiry of certain CEO contracts**

- (1) In this clause —

**commencement day** means the day on which the *Local Government (Administration) Amendment Regulations 2021* regulation 6 comes into operation.

- (2) This clause applies if —
  - (a) upon the expiry of the contract of employment of the person (the incumbent CEO) who holds the position of CEO —
    - (i) the incumbent CEO will have held the position for a period of 10 or more consecutive years, whether that period commenced before, on or after commencement day; and
    - (ii) a period of 10 or more consecutive years has elapsed since a recruitment and selection process for the position was carried out, whether that process was carried out before, on or after commencement day;

and

- (b) the incumbent CEO has notified the local government that they wish to have their contract of employment renewed upon its expiry.
- (3) Before the expiry of the incumbent CEO's contract of employment, the local government must carry out a recruitment and selection process in accordance with these standards to select a person to be employed in the position of CEO after the expiry of the incumbent CEO's contract of employment.

- (4) This clause does not prevent the incumbent CEO's contract of employment from being renewed upon its expiry if the incumbent CEO is selected in the recruitment and selection process referred to in subclause (3) to be employed in the position of CEO.

#### **14. Confidentiality of information**

The local government must ensure that information provided to, or obtained by, the local government in the course of a recruitment and selection process for the position of CEO is not disclosed, or made use of, except for the purpose of, or in connection with, that recruitment and selection process.

### **Division 3 — Standards for review of performance of CEOs**

#### **15. Overview of Division**

This Division sets out standards to be observed by the local government in relation to the review of the performance of CEOs.

#### **16. Performance review process to be agreed between local government and CEO**

- (1) The local government and the CEO must agree on —
- (a) the process by which the CEO's performance will be reviewed; and
  - (b) any performance criteria to be met by the CEO that are in addition to the contractual performance criteria.
- (2) Without limiting subclause (1), the process agreed under subclause (1)(a) must be consistent with clauses 17, 18 and 19.
- (3) The matters referred to in subclause (1) must be set out in a written document.

#### **17. Carrying out a performance review**

- (1) A review of the performance of the CEO by the local government must be carried out in an impartial and transparent manner.
- (2) The local government must —
- (a) collect evidence regarding the CEO's performance in respect of the contractual performance criteria and any additional performance criteria in a thorough and comprehensive manner; and
  - (b) review the CEO's performance against the contractual performance criteria and any additional performance criteria, based on that evidence.

#### **18. Endorsement of performance review by local government**

Following a review of the performance of the CEO, the local government must, by resolution of an absolute majority of the council, endorse the review.

#### **19. CEO to be notified of results of performance review**

After the local government has endorsed a review of the performance of the CEO under clause 18, the local government must inform the CEO in writing of —

- (a) the results of the review; and
- (b) if the review identifies any issues about the performance of the CEO — how the local government proposes to address and manage those issues.



## **Division 4 — Standards for termination of employment of CEOs**

### **20. Overview of Division**

This Division sets out standards to be observed by the local government in relation to the termination of the employment of CEOs.

### **21. General principles applying to any termination**

- (1) The local government must make decisions relating to the termination of the employment of a CEO in an impartial and transparent manner.
- (2) The local government must accord a CEO procedural fairness in relation to the process for the termination of the CEO's employment, including —
  - (a) informing the CEO of the CEO's rights, entitlements and responsibilities in relation to the termination process; and
  - (b) notifying the CEO of any allegations against the CEO; and
  - (c) giving the CEO a reasonable opportunity to respond to the allegations; and
  - (d) genuinely considering any response given by the CEO in response to the allegations.

### **22. Additional principles applying to termination for performance related reasons**

- (1) This clause applies if the local government proposes to terminate the employment of a CEO for reasons related to the CEO's performance.
- (2) The local government must not terminate the CEO's employment unless the local government has —
  - (a) in the course of carrying out the review of the CEO's performance referred to in subclause (3) or any other review of the CEO's performance, identified any issues (the performance issues) related to the performance of the CEO; and
  - (b) informed the CEO of the performance issues; and
  - (c) given the CEO a reasonable opportunity to address, and implement a plan to remedy, the performance issues; and
  - (d) determined that the CEO has not remedied the performance issues to the satisfaction of the local government.
- (3) The local government must not terminate the CEO's employment unless the local government has, within the preceding 12 month period, reviewed the performance of the CEO under section 5.38(1) of the Act.

### **23. Decision to terminate**

Any decision by the local government to terminate the employment of a CEO must be made by resolution of an absolute majority of the council.

### **24. Notice of termination of employment**

- (1) If the local government terminates the employment of a CEO, the local government must give the CEO notice in writing of the termination.
- (2) The notice must set out the local government's reasons for terminating the employment of the CEO.

Policy Adopted: 27 April 2021

### 9.30 Staff Emergency Leave - Policy Suspended

<b>Policy Type:</b>	Staff
<b>Date Adopted:</b>	22 March 2022

<b>Policy No:</b>	<b>S030</b>
<b>Date Last Reviewed:</b>	25 October 2022

<b>Legal (Parent):</b>	5.
------------------------	----

<b>Legal (Subsidiary):</b>	4.
----------------------------	----

ADOPTED POLICY	
<b>Title:</b>	<b>COVID-19 STAFF ISOLATION LEAVE POLICY</b>
<b>Objective:</b>	<b>To establish guidelines for appropriate leave arrangements if/when staff are infected with COVID-19 or are deemed a close contact as per the WA Government Health Guidelines.</b>

#### **POLICY**

Council will offer a special COVID-19 leave allowance providing a maximum of 20 working days (Monday-Friday) paid leave for employees conditional in the event that they are COVID-19 positive or are deemed a close contact and are required to isolate as per the current WA Government mandates.

In the event that an employee is required to take further leave above the allocated 20 working days (Monday-Friday), then they shall be required to use their own accrued leave.

Policy Suspended: 25 October 2022

### 9.31 Appointment of an Acting Chief Executive Officer

<b>Policy Type:</b>	Staff
<b>Date Adopted:</b>	23 August 2022

<b>Policy No:</b>	<b>S031</b>
<b>Date Last Reviewed:</b>	25 October 2022

<b>Legal (Parent):</b>
1. Local Government Act 1995

<b>Legal (Subsidiary):</b>
2.

ADOPTED POLICY	
<b>Title:</b>	<b>APPOINTMENT OF AN ACTING CHIEF EXECUTIVE OFFICER</b>
<b>Objective:</b>	<b>To establish the process for the appointment of an Acting Chief Executive Officer to cover periods of leave longer than 3 days and up to 3 months.</b>

#### DEFINITION:

**Acting CEO** is a person appointed to fulfil the statutory position of CEO during a period where the employed CEO is on planned or unplanned leave.

#### POLICY

This policy applies for periods of planned leave such as long service, annual or personal leave as well as during periods of unforeseen extended absence of the Chief Executive Officer (CEO) for periods of leave of longer than 3 days and up to 13 weeks.

1. The *Local Government Act 1995* requires that a local government is to employ a person to be the CEO of the local government.
2. In accordance with the requirements of the *Local Government Act 1995*, section 5.39(1)(b), the Council has determined that the Deputy Chief Executive Officer (DCEO) is suitably qualified to perform the role of Acting CEO.
  - a. In the event that the DCEO is unavailable to undertake the role of Acting CEO, Council has determined the most suitably qualified person will be the Manager of Planning and Development Services (MPDS).
  - b. Subsequently, if the DCEO and MPDS are unavailable to fulfill the role of Acting CEO, the most suitably qualified person will be the Manger of Works.
3. During periods of the CEO being on annual, personal, and long service leave, or other periods of extended or unplanned absence, it is appropriate for an Acting CEO to perform the duties of the CEO in order to ensure the efficient operation of the Shire administration.
4. An employee who has been appointed to the role of Acting CEO will be remunerated at the hourly rate normally paid to the permanent CEO.
5. If the CEO is to be on leave or absent for longer than 13 weeks, a formal resolution of Council appointing an Acting CEO is required.

## 9.32 Grader Loading

<b>Policy Type:</b>	Staff
<b>Date Adopted:</b>	25 September 2022

<b>Policy No:</b>	<b>S032</b>
<b>Date Last Reviewed:</b>	25 October 2022

<b>Legal (Parent):</b>
1.

<b>Legal (Subsidiary):</b>
1.

ADOPTED POLICY	
<b>Title:</b>	<b>GRADER LOADING</b>
<b>Objective:</b>	<b>To establish a higher duties pay rate when an outside staff member is asked to operate a grader.</b>

### **POLICY**

Members of the outside crew who are asked to operate a grader shall be paid at the Maintenance Grader Operator's rate less \$1.00 per hour.

1. If an employee is operating a grader for 5 or more hours, the higher rate will apply to all hours worked on the day.
2. If an employee operates a grader for less than 5 hours, the higher rate will only apply to the hours spent on the grader.

### 9.33 Higher Duties Policy

<b>Policy Type:</b>	Staff
<b>Date Adopted:</b>	27 September 2022

<b>Policy No:</b>	<b>S033</b>
<b>Date Last Reviewed:</b>	25 October 2022

<b>Legal (Parent):</b>
1. Local Government Award 2020

<b>Legal (Subsidiary):</b>
1.

ADOPTED POLICY	
<b>Title:</b>	<b>HIGHER DUTIES POLICY</b>
<b>Objective:</b>	<b>To establish a consistent approach to the remuneration of higher duties opportunities.</b>

#### POLICY

The purpose of this policy is to provide a standard and consistent approach to the management of, and remuneration for, higher duties opportunities at the Shire of Beverley. The opportunity for employees to temporarily act in a role of increased responsibility, authority, and/or delegation contributes to a flexible and highly skilled workforce and provides both career development opportunities and valuable knowledge transfer.

1. In alignment with the Local Government Industry Award 2020 16.4(a), the Higher Duties Policy applies to staff who are requested to act in or relieve a higher level position for more than one day.
  - a. Where an employee performs higher duties and is in receipt of a higher minimum rate for 3 continuous months or more immediately prior to starting a period of paid annual leave or paid personal/carer's leave, the leave will be paid at the high minimum hourly rate (LGIA 2020 16.4(b)(i))
  - b. The amount of annual leave or personal/carer's leave that is paid at the higher minimum hourly rate will be proportional to the amount of annual leave or personal/carer's leave accrued whilst performing the higher duties work (LGIA 2020 16.4(b)(ii))
2. The higher duties rate of pay will be equivalent to the rate normally paid to the person assigned in that role, less \$1.00 per hour to account for the skills and experience held by the person ordinarily filling said role.
3. If an employee is asked to perform two roles over the course of the day, the higher duties rate of pay will apply to all hours worked.
4. Any employee directed to act in a higher role must have written authorisation to do so from a member of the executive management team.

## 9.34 Staff Remuneration

<b>Policy Type:</b>	Staff
<b>Date Adopted:</b>	25 September 2022

<b>Policy No:</b>	<b>S034</b>
<b>Date Last Reviewed:</b>	25 October 2022

<b>Legal (Parent):</b>
1. Local Government Industry Award 2020

<b>Legal (Subsidiary):</b>
1.

ADOPTED POLICY	
<b>Title:</b>	<b>STAFF REMUNERATION</b>
<b>Objective:</b>	<b>To establish clear and consistent remuneration principles and scales for non-executive Shire staff.</b>

### **POLICY**

The aim of this policy is to provide remuneration guidance for non-executive Shire staff in accordance with the Local Government Industry Award 2020.

The Shire of Beverley Staff Remuneration Policy is guided on the following principles:

- Liveable wages for all employees
- Consistency in remuneration decisions
- Attract and retain quality workers across all aspects of Shire operations
- Gender pay equity

With these principles in mind, the Shire of Beverley has laid out the following framework regarding remuneration.

### **WAGE SCHEDULE**

The Shire of Beverley follows the guidance of the LGIA 2020 by applying a skill-based classification to each employee position based on criteria listed within the Award.

In keeping with the above principles, the Shire will start all permanent full- and part-time employees on the base rate set out in the Award for each classification level, along with an additional 16% as outlined below.

<b>Position</b>	<b>Level</b>
<b>Administration Staff:</b>	
Customer Service Officers	3 + 16%
Executive Assistant	4 + 16%
Finance Officer	4 + 16%
Payroll/HR Officer	4 + 16%
Projects/WHS Officer	4 + 16%
Senior Finance Officer	5 + 16%
<b>Works Staff:</b>	
Cleaners	2 + 16%
Parks & Gardens Utility Workers	3 + 16%
Construction & Maintenance Plant Operators	4 + 16%
Mechanic	4 + 16%
Grader Operators	4 + 16%
Parks & Gardens Supervisor	4 + 16%
Construction & Maintenance Supervisor	5 + 16%
Maintenance Officer	8 + 16%

Casual employees will start on the Award base rate + 25%.

Additional increases are to be agreed upon by the CEO and DCEO and based on position scope and employee performance.

# 10. Works

## 10.1 Crossover Policy

<b>Policy Type:</b>	Works
<b>Date Adopted:</b>	September 2014

<b>Policy No:</b>	<b>W001</b>
<b>Date Last Reviewed:</b>	25 October 2022

<b>Legal (Parent):</b>
1. Local Government Act 1995 Sc 9.1 cl. 7

<b>Legal (Subsidiary):</b>
1. Local Government Regulations 1996 12 -17

ADOPTED POLICY	
<b>Title:</b>	<b>CROSSOVER POLICY</b>
<b>Objective:</b>	<b>To provide uniform specifications and assist with drainage and visual amenity.</b>

### Policy

That each property be required to have installed at the owners cost, less a 50% subsidy of the estimated cost, an Access and/or Crossover in accordance with specifications detailed in Attachments 1.1A, 1.1B, 1.1C, 1.1D & 1.1E to this policy.

The Manager of Works is to ensure a completed works request form or other written documentation is obtained prior to commencement of works.

### **Property Access And Crossover Specifications**

Subject to variation at the discretion of Council, the policy of Council in regarding access and crossovers shall be:

Construction of 150mm compacted gravel carriageway from the property boundary to the roadside, including the installation of culverts where necessary.

**Council shall pay up to 50% of the cost, of a standard crossover, of standard dimensions to following specifications; anything outside these dimensions/standards will need to be approved by Council. One crossover per property.**

### **Industrial**

Standard width over full length = 7m

Standard widening at roadside junction = 45 degrees for 1 metre each side or from culvert to roadside.

Installation of concrete headwalls where a culvert is installed

150mm reinforced concrete on 100mm compacted sand where footpath is paved. 150mm compacted gravel where existing footpath / verge is gravel.



**Rural**

Standard width over full length = 4.8m – 7.2m

Standard widening at roadside junction = 45 degrees for 1 metre each side to roadside.

150mm compacted gravel pavement.

**Residential**

Standard width over full length = 3m

Standard width over full length = 4.8m with culvert

Standard widening at roadside junction = 45 degrees 1 metre each side or from culvert to roadside.

Installation of concrete headwalls where a culvert is installed

100mm reinforced concrete on 100mm compacted sand where footpath is paved. 150mm compacted gravel where existing footpath / verge is gravel.

**General Conditions**

- 1) Only one crossover subsidy will be paid to each separate rate assessment. This will not be paid for Subdivisions.
- 2) Council will provide a subsidy only on roads under Council control. Crossovers on the following roads are under the control of Main Roads WA, and application should be made to them —
  - a. Great Southern Highway
  - b. Brookton Highway
  - c. York Quairading Road
- 3) Prior to constructing any crossover within a road reserve, an application showing the proposed location and other details is required.
- 4) Prior to commencing any work, Council's Manager of Works will inspect the site and provide written approval or requirement for alterations to the location. The approval will specify the size of pipe, if required.
- 5) Maximum and minimum dimensions of access apply(See attached diagrams)
- 6) Works are to be carried to the set specification by contractor, owner or council
- 7) Payment of the subsidy will not be made until the work is complete, and has been inspected and is authorised by the Manager of Works.
- 8) Crossover subsidy will be paid with and without pipes as set out in the Fees & Charges Schedule. Work in excess of that specified is fully at the landowners cost, and will not be subsidised by Council.
- 9) All culvert pipes to be class 4 reinforced concrete pipe
- 10) Culvert pipes to be offset from the drain to allow adequate cover over the pipe.
- 11) No access to be located within 6.0 metres of a side road boundary.
- 12) Any ongoing maintenance will be the landowner's responsibility

Policy Amended: September 2016

**ATTACHMENT 1.1A  
DIAGRAM INDUSTRIAL AND COMMERCIAL CROSSOVER**

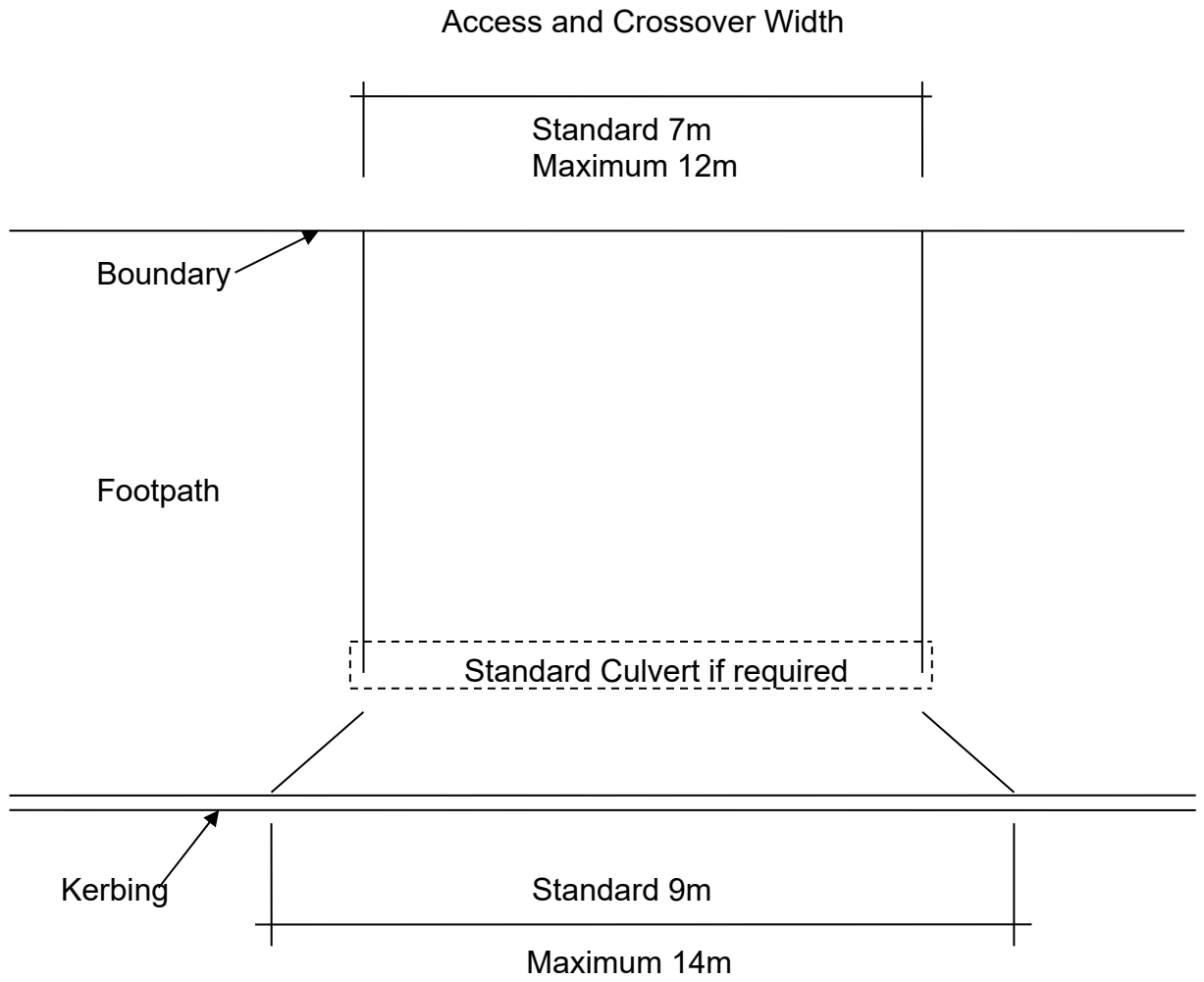

**ATTACHMENT 1.1B  
DIAGRAM RURAL CROSSOVER**

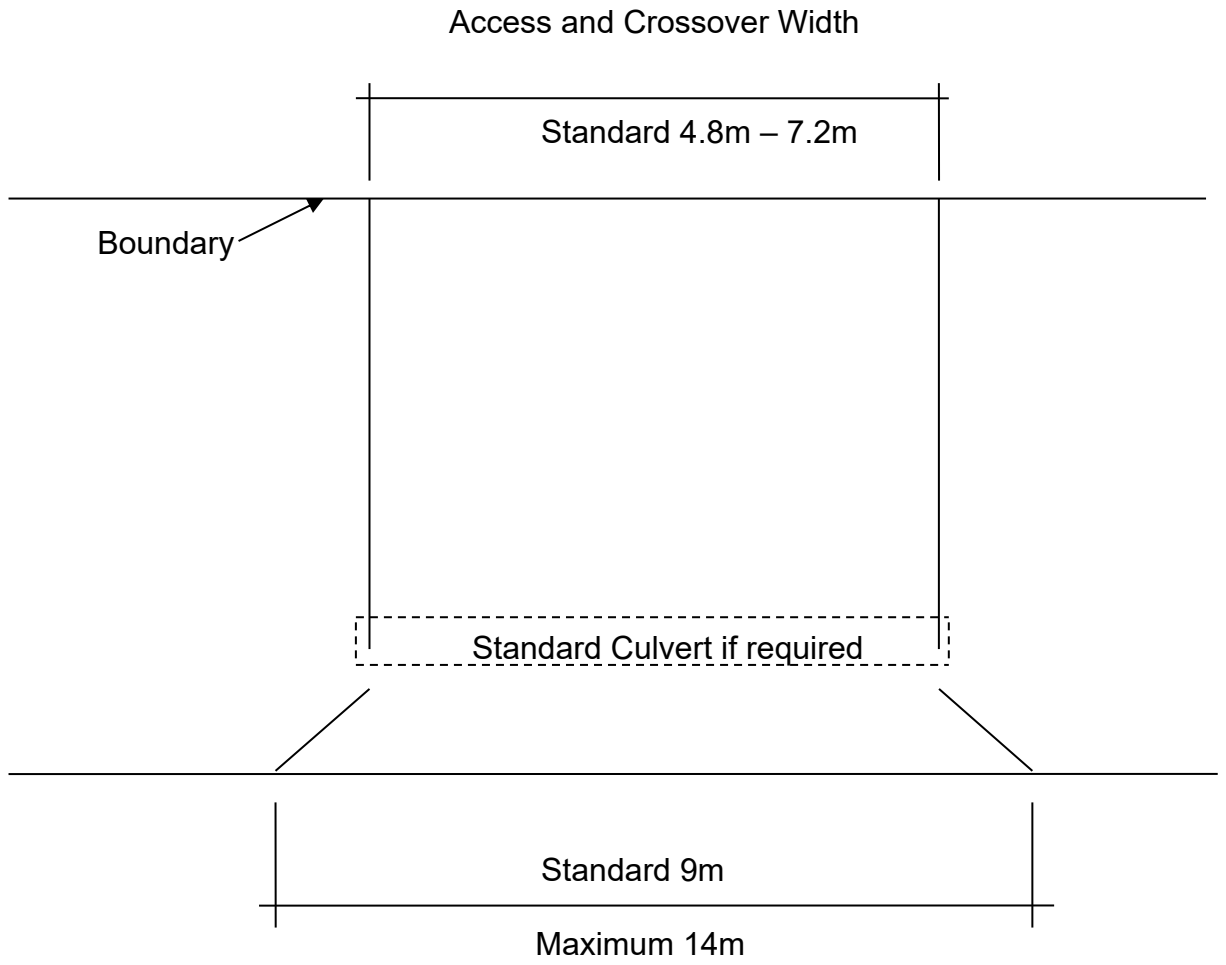

**ATTACHMENT 1.1C  
DIAGRAM RESIDENTIAL CROSSOVER**

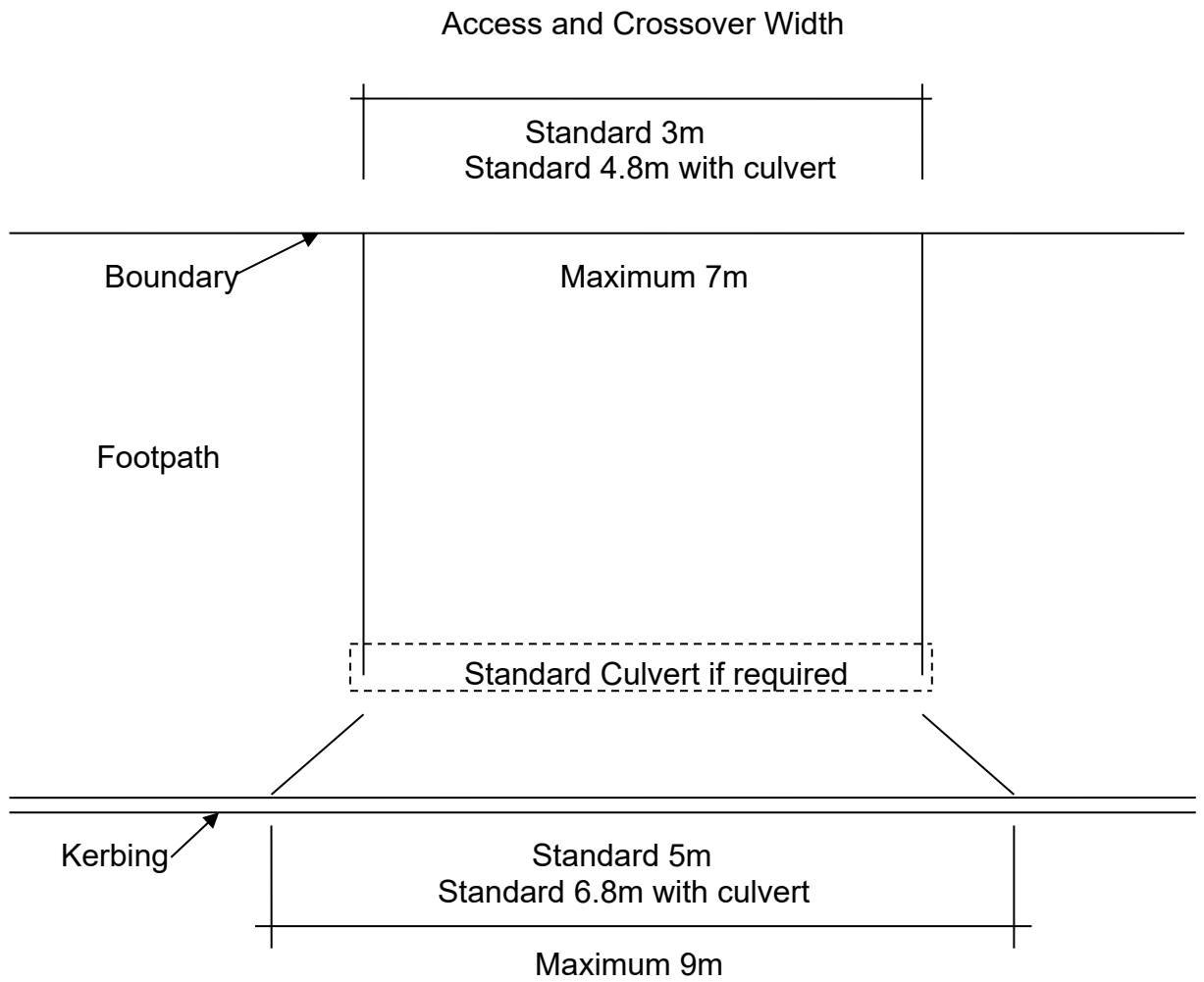

**ATTACHMENT 1.1D  
DIAGRAM CULVERT HEADWALL**

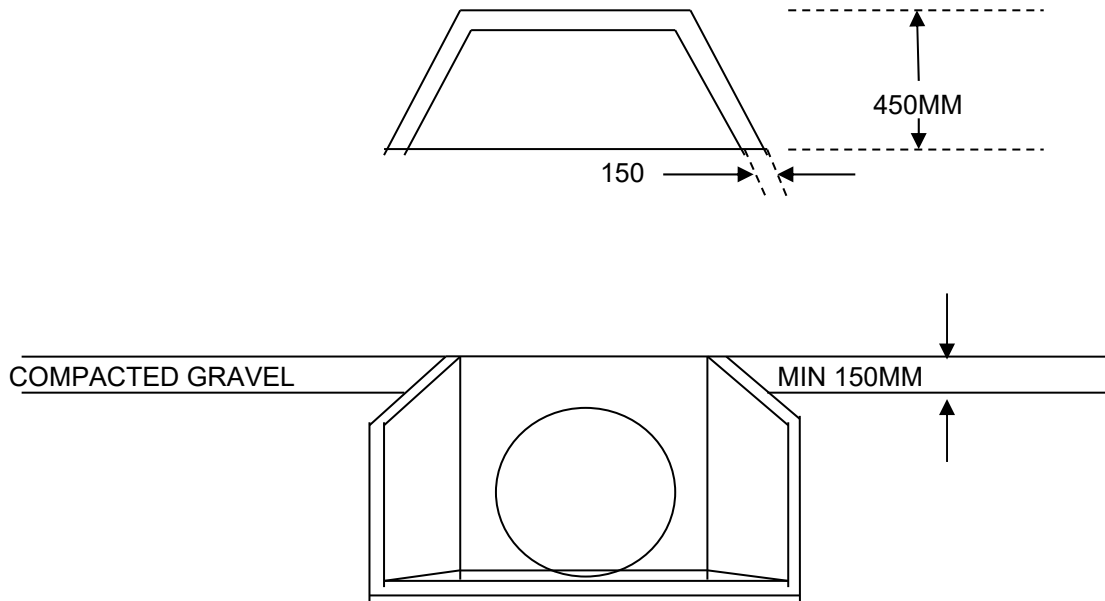

OR

COMMERCIALLY MANUFACTURED HEADWALL (I.E. ROCLA , HUMES)

**ATTACHMENT 1.1E  
DIAGRAM CULVERT LOCATION**

Pipes to be offset from the drain to allow for adequate cover and not to obstruct the road

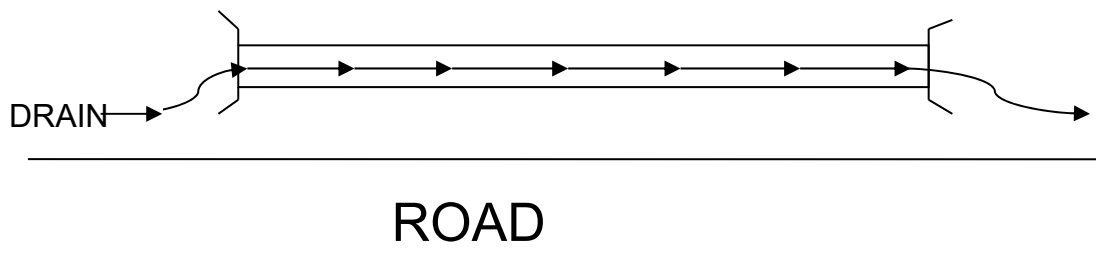

## 10.2 Gravel Pit Rehabilitation

<b>Policy Type:</b>	Works
<b>Date Adopted:</b>	September 2014

<b>Policy No:</b>	<b>W002</b>
<b>Date Last Reviewed:</b>	25 October 2022

<b>Legal (Parent):</b>
1.

<b>Legal (Subsidiary):</b>
1.

ADOPTED POLICY	
<b>Title:</b>	<b>GRAVEL PIT REHABILITATION</b>
<b>Objective:</b>	<b>To rehabilitate private property and Shire reserves where the Shire has completed extraction of gravel.</b>

### Policy

Unused Pits – the site is to be spread and levelled as much as possible. The site is to be ripped at 3 metre intervals where necessary.

New Pits – are to be photographed prior to excavation. Topsoil should be stock piled, then following final excavation the topsoil is to be pushed over the excavation and the site revegetated to the original state.

Timbered pits located in grazing paddocks are to be fenced until revegetated by planted native trees.

Policy Amended: 25 October 2016

### 10.3 Gravel Royalties

<b>Policy Type:</b>	Works
<b>Date Adopted:</b>	August 2016

<b>Policy No:</b>	<b>W003</b>
<b>Date Last Reviewed:</b>	25 October 2022

<b>Legal (Parent):</b>
1.

<b>Legal (Subsidiary):</b>
1.

<b>ADOPTED POLICY</b>	
<b>Title:</b>	<b>GRAVEL ROYALTIES</b>
<b>Objective:</b>	<b>To ensure landholders are compensated for gravel obtained from their private pits.</b>

**Policy**

To obtain gravel from landowners throughout the Beverley District, the Shire will pay a gravel royalty of \$2.00ex GST per cubic metre payable to eligible landholders with the royalty rate to be reviewed annually.

## 10.4 Waste Facility Spill Policy

<b>Policy Type:</b>	Works
<b>Date Adopted:</b>	27 March 2018

<b>Policy No:</b>	<b>W004</b>
<b>Date Last Reviewed:</b>	25 October 2022

<b>Legal (Parent):</b>
1.

<b>Legal (Subsidiary):</b>
1.

ADOPTED POLICY	
<b>Title:</b>	<b>WASTE FACILITY SPILL POLICY</b>
<b>Objective:</b>	<b>To meet the requirements in regard to management of sewer overflow or spills from or at the Shire of Beverley Septage Pit.</b>

### Policy

#### 1. POLICY INTENT

This policy provides the framework for Beverley Shire Council to meet the requirements in regard to management of sewer overflow or spills from or at the Shire of Beverley Septage Pit. This policy also raises the awareness of Beverley Shire Council employees regarding their obligations and duties in regard to the management of sewer overflow or spills with respect to the DER Licence L8536/2011/1 for the Shire of Beverley Landfill.

#### 2. SCOPE

This policy applies to overflow or spills that may occur from the Septage Pit structure as a result of:

- Excessive rainfall;
- Accidental damage to the Septage Pit; or
- Spill during emptying of vehicle receptacle.

#### 3. SPILL PROCEDURE

- a) All contractors given the access key to the septage pit are advised to notify the Shire of Beverley office of any spillages upon return of the key.
- b) Spillages are to be reported to the Shire of Beverley Works Manager, CEO or DCEO to arrange for appropriate action.
- c) Sand is to be placed on any excessive liquid to a spadeable consistency. The spadeable waste is then to be transferred into a suitable receptacle and transferred to the Shire of Beverley Landfill site.
- d) The site is to then be inspected to determine if effluent has or has the potential to reach any water courses or ground water or potential for environmental harm, and appropriate action taken.



#### **4. LARGE SPILLS OR PIT FAILURE**

- a) Where large spills or failure of the septage pit occurs the Shire of Beverley Works Supervisor, CEO, D/CEO and EHO are to be notified.
- b) The DER are also to be notified.
- c) Liquid waste is to be pumped into trucks from a licensed contractor, such as Makin and Sons or Darry's Plumbing from York, with a suitable receptacle and transferred to an alternate septage site, such as the Shire of York Septage Ponds.
- d) Sand or other suitable absorbent material is to be placed on any remaining liquid to form a spadeable consistency and then to be transferred to a suitable receptacle and disposed of at the Shire of Beverley Landfill.
- e) The site is to then be inspected to determine if effluent has or has the potential to reach any water courses or ground water or potential for environmental harm, and appropriate action taken.

#### **5. GENERAL CONDITION CHECKS**

The septage pit is to be inspected monthly to determine any damage to the pit or spillages that have not been adequately cleaned up.

#### **6. TRAINING, RESOURCES AND MITIGATION**

Beverley Shire Council shall ensure a training program for relevant staff is implemented.

Beverley Shire Council shall ensure that adequate resources are available to carry out the necessary works.

This includes auditing procedures and procedures for review and correction of an overflow or spill event.

Remediation and clean-up plans in place for areas affected by sewer overflow or spills.

#### **7. SYSTEM FOR RECORD KEEPING OF OVERFLOW OR SPILLS**

Methodology is in place to investigate the cause of overflow or spills, initiate preventative measures, and measure and report on the effectiveness of the preventative measures.

In this regard, large spills are to be documented and causes determined. Subsequent to this remedial measures and procedures are to be implemented to prevent further incidents or spills.

Date Last Updated and Published: 23 November 2021

**13. ELECTED MEMBERS' MOTIONS WHERE NOTICE HAS BEEN GIVEN**

Nil

**14. NEW BUSINESS ARISING BY ORDER OF THE MEETING**

New Business of an urgent matter only arising by order of the meeting.

**15. CLOSURE**

The Chairman to declare the meeting closed.